

# Damage Mechanisms Affecting Fixed Equipment in the Refining Industry

API RECOMMENDED PRACTICE 571  
SECOND EDITION, APRIL 2011



AMERICAN PETROLEUM INSTITUTE



# **Damage Mechanisms Affecting Fixed Equipment in the Refining Industry**

**Downstream Segment**

API RECOMMENDED PRACTICE 571  
SECOND EDITION, APRIL 2011



AMERICAN PETROLEUM INSTITUTE

## Special Notes

API publications necessarily address problems of a general nature. With respect to particular circumstances, local, state, and federal laws and regulations should be reviewed.

Neither API nor any of API's employees, subcontractors, consultants, committees, or other assignees make any warranty or representation, either express or implied, with respect to the accuracy, completeness, or usefulness of the information contained herein, or assume any liability or responsibility for any use, or the results of such use, of any information or process disclosed in this publication. Neither API nor any of API's employees, subcontractors, consultants, or other assignees represent that use of this publication would not infringe upon privately owned rights.

API publications may be used by anyone desiring to do so. Every effort has been made by the Institute to assure the accuracy and reliability of the data contained in them; however, the Institute makes no representation, warranty, or guarantee in connection with this publication and hereby expressly disclaims any liability or responsibility for loss or damage resulting from its use or for the violation of any authorities having jurisdiction with which this publication may conflict.

API publications are published to facilitate the broad availability of proven, sound engineering and operating practices. These publications are not intended to obviate the need for applying sound engineering judgment regarding when and where these publications should be utilized. The formulation and publication of API publications is not intended in any way to inhibit anyone from using any other practices.

Any manufacturer marking equipment or materials in conformance with the marking requirements of an API standard is solely responsible for complying with all the applicable requirements of that standard. API does not represent, warrant, or guarantee that such products do in fact conform to the applicable API standard.

Users of this Recommended Practice should not rely exclusively on the information contained in this document. Sound business, scientific, engineering, and safety judgment should be used in employing the information contained herein.

API is not undertaking to meet the duties of employers, manufacturers, or suppliers to warn and properly train and equip their employees, and others exposed, concerning health and safety risks and precautions, nor undertaking their obligations to comply with authorities having jurisdiction.

Information concerning safety and health risks and proper precautions with respect to particular materials and conditions should be obtained from the employer, the manufacturer or supplier of that material, or the material safety data sheet.

All rights reserved. No part of this work may be reproduced, translated, stored in a retrieval system, or transmitted by any means, electronic, mechanical, photocopying, recording, or otherwise, without prior written permission from the publisher. Contact the Publisher, API Publishing Services, 1220 L Street, NW, Washington, DC 20005.

*Copyright © 2010 American Petroleum Institute*

## Foreword

Nothing contained in any API publication is to be construed as granting any right, by implication or otherwise, for the manufacture, sale, or use of any method, apparatus, or product covered by letters patent. Neither should anything contained in the publication be construed as insuring anyone against liability for infringement of letters patent.

Shall: As used in a standard, “shall” denotes a minimum requirement in order to conform to the specification.

Should: As used in a standard, “should” denotes a recommendation or that which is advised but not required in order to conform to the specification.

This document was produced under API standardization procedures that ensure appropriate notification and participation in the developmental process and is designated as an API standard. Questions concerning the interpretation of the content of this publication or comments and questions concerning the procedures under which this publication was developed should be directed in writing to the Director of Standards, American Petroleum Institute, 1220 L Street, NW, Washington, DC 20005. Requests for permission to reproduce or translate all or any part of the material published herein should also be addressed to the director.

Generally, API standards are reviewed and revised, reaffirmed, or withdrawn at least every five years. A one-time extension of up to two years may be added to this review cycle. Status of the publication can be ascertained from the API Standards Department, telephone (202) 682-8000. A catalog of API publications and materials is published annually by API, 1220 L Street, NW, Washington, DC 20005.

Suggested revisions are invited and should be submitted to the Standards Department, API, 1220 L Street, NW, Washington, DC 20005, [standards@api.org](mailto:standards@api.org).



# TABLE OF CONTENTS

<b>SECTION 1</b>	.....	<b>1-1</b>
1.1	Introduction .....	1-3
1.2	Scope .....	1-3
1.3	Organization and Use .....	1-4
1.4	References .....	1-4
1.5	Definitions of Terms .....	1-4
1.6	Technical Inquires.....	1-4
<b>SECTION 2</b>	.....	<b>2-1</b>
2.1	Standards.....	2-3
2.2	Other References .....	2-6
<b>SECTION 3</b>	.....	<b>3-1</b>
3.1	Terms .....	3-3
3.2	Symbols and Abbreviations.....	3-4
<b>SECTION 4</b>	.....	<b>4-1</b>
4.1	General.....	4-3
4.2	Mechanical and Metallurgical Failure Mechanisms.....	4-3
4.2.1	Graphitization .....	4-3
4.2.2	Softening (Spheroidization) .....	4-7
4.2.3	Temper Embrittlement .....	4-10
4.2.4	Strain Aging .....	4-14
4.2.5	885°F (475°C) Embrittlement .....	4-16
4.2.6	Sigma Phase Embrittlement.....	4-19
4.2.7	Brittle Fracture.....	4-27
4.2.8	Creep and Stress Rupture .....	4-32
4.2.9	Thermal Fatigue.....	4-39
4.2.10	Short Term Overheating – Stress Rupture .....	4-46
4.2.11	Steam Blanketing .....	4-51
4.2.12	Dissimilar Metal Weld (DMW) Cracking .....	4-54
4.2.13	Thermal Shock.....	4-63
4.2.14	Erosion/Erosion – Corrosion .....	4-65
4.2.15	Cavitation .....	4-70
4.2.16	Mechanical Fatigue .....	4-74
4.2.17	Vibration-Induced Fatigue .....	4-81
4.2.18	Refractory Degradation .....	4-84
4.2.19	Reheat Cracking .....	4-87
4.2.20	Gaseous Oxygen-Enhanced Ignition and Combustion .....	4-93
4.3	Uniform or Localized Loss of Thickness.....	4-101
4.3.1	Galvanic Corrosion .....	4-101
4.3.2	Atmospheric Corrosion .....	4-105
4.3.3	Corrosion Under Insulation (CUI) .....	4-108
4.3.4	Cooling Water Corrosion.....	4-117
4.3.5	Boiler Water Condensate Corrosion .....	4-120
4.3.6	CO <sub>2</sub> Corrosion.....	4-124
4.3.7	Flue-Gas Dew-Point Corrosion .....	4-128
4.3.8	Microbiologically Induced Corrosion (MIC).....	4-130
4.3.9	Soil Corrosion.....	4-136
4.3.10	Caustic Corrosion .....	4-140
4.3.11	Dealloying .....	4-143
4.3.12	Graphitic Corrosion .....	4-147
4.4	High Temperature Corrosion [ $>400^{\circ}\text{F}$ ( $204^{\circ}\text{C}$ )] .....	4-153
4.4.1	Oxidation .....	4-153
4.4.2	Sulfidation .....	4-159
4.4.3	Carburization .....	4-166

4.4.4	Decarburization .....	4-169
4.4.5	Metal Dusting .....	4-172
4.4.6	Fuel Ash Corrosion .....	4-175
4.4.7	Nitriding .....	4-180
4.5	Environment – Assisted Cracking.....	4-184
4.5.1	Chloride Stress Corrosion Cracking (ClSCC).....	4-184
4.5.2	Corrosion Fatigue .....	4-193
4.5.3	Caustic Stress Corrosion Cracking (Caustic Embrittlement).....	4-199
4.5.4	Ammonia Stress Corrosion Cracking .....	4-206
4.5.5	Liquid Metal Embrittlement (LME) .....	4-210
4.5.6	Hydrogen Embrittlement (HE) .....	4-215
4.5.7	Ethanol Stress Corrosion Cracking (SCC) .....	4-220
4.5.8	Sulfate Stress Corrosion Cracking.....	4-227
SECTION 5	.....	5-1
5.1	General.....	5-3
5.1.1	Uniform or Localized Loss in Thickness Phenomena.....	5-3
5.1.1.1	Amine Corrosion .....	5-3
5.1.1.2	Ammonium Bisulfide Corrosion (Alkaline Sour Water) .....	5-9
5.1.1.3	Ammonium Chloride Corrosion .....	5-13
5.1.1.4	Hydrochloric Acid (HCl) Corrosion .....	5-16
5.1.1.5	High Temp H <sub>2</sub> /H <sub>2</sub> S Corrosion .....	5-19
5.1.1.6	Hydrofluoric (HF) Acid Corrosion .....	5-23
5.1.1.7	Naphthenic Acid Corrosion (NAC) .....	5-31
5.1.1.8	Phenol (Carbolic Acid) Corrosion .....	5-35
5.1.1.9	Phosphoric Acid Corrosion .....	5-37
5.1.1.10	Sour Water Corrosion (Acidic) .....	5-39
5.1.1.11	Sulfuric Acid Corrosion .....	5-41
5.1.1.12	Aqueous Organic Acid Corrosion.....	5-45
5.1.2	Environment-Assisted Cracking.....	5-49
5.1.2.1	Polythionic Acid Stress Corrosion Cracking (PASCC).....	5-49
5.1.2.2	Amine Stress Corrosion Cracking .....	5-55
5.1.2.3	Wet H <sub>2</sub> S Damage (Blistering/HIC/SOHIC/SSC) .....	5-60
5.1.2.4	Hydrogen Stress Cracking - HF.....	5-70
5.1.2.5	Carbonate Stress Corrosion Cracking (ACSCC) .....	5-72
5.1.3	Other Mechanisms .....	5-83
5.1.3.1	High Temperature Hydrogen Attack (HTHA).....	5-83
5.1.3.2	Titanium Hydriding .....	5-90
5.2	Process Unit PFD's .....	5-94
ANNEX A	.....	A-1
A.1	Introduction .....	A-3
A.2	Inquiry Format .....	A-3



# SECTION 1

## INTRODUCTION AND SCOPE

1.1	Introduction .....	1-3
1.2	Scope .....	1-3
1.3	Organization and Use .....	1-4
1.4	References.....	1-4
1.5	Definitions of Terms .....	1-4
1.6	Technical Inquires.....	1-4

*This page intentionally left blank.*

## 1.1 Introduction

The ASME and API design codes and standards for pressurized equipment provide rules for the design, fabrication, inspection, and testing of new pressure vessels, piping systems, and storage tanks. These codes do not address equipment deterioration while in service and that deficiencies due to degradation or from original fabrication may be found during subsequent inspections. Fitness-For-Service (FFS) assessments are quantitative engineering evaluations that are performed to demonstrate the structural integrity of an in-service component containing a flaw or damage. The first step in a fitness-for-service assessment performed in accordance with API 579-1/ASME FFS-1 is to identify the flaw type and the cause of damage. Proper identification of damage mechanisms for components containing flaws or other forms of deterioration is also the first step in performing a Risk-Based Inspection (RBI) in accordance with API RP 580.

When conducting an FFS assessment or RBI study, it is important to determine the cause(s) of the damage or deterioration observed, or anticipated, and the likelihood and degree of further damage that might occur in the future. Flaws and damage that are discovered during an in-service inspection can be the result of a pre-existing condition before the component entered service and/or could be service-induced. The root causes of deterioration could be due to inadequate design considerations including materials selection and design details, or the interaction with aggressive environments/conditions that the equipment is subjected to during normal service or during transient periods.

One factor that complicates an FFS assessment or RBI study for refining and petrochemical equipment is that material/environmental condition interactions are extremely varied. Refineries and chemical plants contain many different processing units, each having its own combination of aggressive process streams and temperature/pressure conditions. In general, the following types of damage are encountered in petrochemical equipment:

- a) General and local metal loss due to corrosion and/or erosion
- b) Surface connected cracking
- c) Subsurface cracking
- d) Microfissuring/microvoid formation
- e) Metallurgical changes

Each of these general types of damage may be caused by a single or multiple damage mechanisms. In addition, each of the damage mechanisms occurs under very specific combinations of materials, process environments, and operating conditions.

## 1.2 Scope

This recommended practice provides general guidance as to the most likely damage mechanisms affecting common alloys used in the refining and petrochemical industry and is intended to introduce the concepts of service-induced deterioration and failure modes. These guidelines provide information that can be utilized by plant inspection personnel to assist in identifying likely causes of damage; to assist with the development of inspection strategies; to help identify monitoring programs to ensure equipment integrity.

The summary provided for each damage mechanism provides the fundamental information required for an FFS assessment performed in accordance with API 579-1/ASME FFS-1 or an RBI study performed in accordance with API RP 580.

The damage mechanisms in this recommended practice cover situations encountered in the refining and petrochemical industry in pressure vessels, piping, and tankage. The damage mechanism descriptions are not intended to provide a definitive guideline for every possible situation that may be encountered, and the reader may need to consult with an engineer familiar with applicable degradation modes and failure mechanisms, particularly those that apply in special cases.

This document incorporates information gathered from major incidents in the refining industry and is intended to be consistent with applicable API documents as well as other related best-industry standards and practices. It is intended to provide guidance to inspection personnel but should not be considered the final technical basis for damage mechanism assessment and analysis.

### 1.3 Organization and Use

The information for each damage mechanism is provided in a set format as shown below. This recommended practice format facilitates use of the information in the development of inspection programs, FFS assessment and RBI applications.

- a) Description of Damage – a basic description of the damage mechanism.
- b) Affected Materials – a list of the materials prone to the damage mechanism.
- c) Critical Factors – a list of factors that affect the damage mechanism (i.e. rate of damage).
- d) Affected Units or Equipment – a list of the affected equipment and/or units where the damage mechanism commonly occurs is provided. This information is also shown on process flow diagrams for typical process units.
- e) Appearance or Morphology of Damage – a description of the damage mechanism, with pictures in some cases, to assist with recognition of the damage.
- f) Prevention / Mitigation – methods to prevent and/or mitigate damage.
- g) Inspection and Monitoring – recommendations for NDE for detecting and sizing the flaw types associated with the damage mechanism.
- h) Related Mechanisms – a discussion of related damage mechanisms.
- i) References – a list of references that provide background and other pertinent information.

Damage mechanisms that are common to a variety of industries including refining and petrochemical, pulp and paper, and fossil utility are covered in [Section 4.0](#).

Damage mechanisms that are specific to the refining and petrochemical industries are covered in [Section 5](#). In addition, process flow diagrams are provided in [5.2](#) to assist the user in determining primary locations where some of the significant damage mechanisms are commonly found.

### 1.4 References

Standards, codes and specifications cited in the recommended practices are listed in [Section 2](#). References to publications that provide background and other information pertinent to the damage mechanism are provided in the paragraph covering each damage mechanism.

### 1.5 Definitions of Terms

A glossary of terminology and abbreviations used throughout this document is provided in [Section 3.0](#).

### 1.6 Technical Inquiries

The procedure to submit a request for an interpretation to API RP 571 is provided in [Annex A](#).

## SECTION 2

### REFERENCES

2.1	Standards.....	2-3
2.2	Other References .....	2-6

*This page intentionally left blank.*

## 2.1 Standards

The following standards, codes and specifications are cited in the recommended practice. Unless otherwise specified, the most recent editions of these documents shall apply.

### API

API 510	<i>Pressure Vessel Inspection Code</i>
API 530	<i>Calculation of Heater Tube Thickness in Petroleum Refineries</i>
API 570	<i>Piping Inspection Code Inspection, Repair, Alteration, and Rerating of In-Service Piping Systems</i>
RP 577	<i>Material Verification Program for New and Existing Alloy Piping Systems</i>
RP 578	<i>Welding Inspection and Metallurgy</i>
RP 580	Recommended Practice for Risk Based Inspection
RP 581	<i>Risk-Based Inspection Technology</i>
RP 582	<i>Welding Guidelines for the Chemical, Oil, and Gas Industries</i>
API 653	<i>Tank Inspection, Repair, Alteration, And Reconstruction</i>
API 579-1/ASME FFS-1	<i>Fitness-For-Service</i>
API 581	<i>Risk-Based Inspection Technology</i>
Std. 660	<i>Shell and Tube Heat Exchangers for General Refinery Service</i>
RP 751	<i>Safe Operation of Hydrofluoric Acid Alkylation Units</i>
RP 932-B	<i>Design, Materials, Fabrication, Operation and Inspection Guidelines for Corrosion Control in Hydroprocessing Reactor Effluent Air Cooler (REAC) Systems</i>
RP 934-A	<i>Materials and Fabrication Requirements for 2-1/4Cr-1Mo, 2-1/4Cr-1Mo-1/4V, 3Cr 1Mo and 3Cr-1Mo-1/4V Steel Heavy Wall Pressure Vessels for High Temperature, High Pressure Service</i>
RP 934-B	<i>API Recommended Practice 934-B, Fabrication Considerations for 1/4V Steel Heavy Wall Pressure Vessels for High Temperature, High Pressure Hydrogen Service</i>
RP 934-C	<i>Materials and Fabrication Requirements for 1 1/4Cr-1/2Mo Steel Heavy Wall Pressure Vessels for High Temperature, High Pressure Hydrogen Service</i>
RP 934-D	<i>Technical Report on the Materials and Fabrication Issues of 1 1/4 Cr - 1/2 Mo and 1 Cr - 1/2 Mo Steel Pressure Vessels, American Petroleum Institute, Washington, D.C.</i>
RP 934-E	<i>Recommended Practice for Materials and Fabrication of 1 1/4Cr-1/2Mo Steel Pressure Vessels for Service above 825°F (441°C),</i>
RP 939-C	<i>Guidelines for Avoiding Sulfidation Corrosion Failures in Oil Refineries</i>
RP 939-D	Stress Corrosion Cracking of Carbon Steel in Fuel-Grade Ethanol: Review, Experience Survey, Field Monitoring, and Laboratory Testing
RP 939-E	<i>Identification, Repair, and Mitigation of Cracking of Steel Equipment in Fuel Ethanol Service</i>
RP 941	<i>Steels for Hydrogen Service at Elevated Temperatures and Pressures in Petroleum Refineries and Petrochemical Plants</i>
RP 945	<i>Avoiding Environmental Cracking in Amine Units</i>

ASM<sup>1</sup>

Metals Handbook      Volume 1, *Properties and Selection: Iron, Steels, and High-Performance Alloys*; Volume 11, *Corrosion in Petroleum Refining and Petrochemical Operations*; Volume 13, *Failure Analysis and Prevention*

ASME<sup>2</sup>

Boiler and Pressure Vessel Code      Section III, Division I, *Rules for Construction of Nuclear Power Plant Components*.

Boiler and Pressure Vessel Code      Section VIII Division 1 & 2, *Rules for Construction of Pressure Vessels*.

ASTM<sup>3</sup>

MNL41      *Corrosion in the Petrochemical Industry*

STP1428      *Thermo-mechanical Fatigue Behavior of Materials*

BSI<sup>4</sup>

BSI 7910      *Guidance on Methods for Assessing the Acceptability of Flaws in Fusion Welded Structures*

MPC<sup>5</sup>

Report FS-26      *Fitness-For Service Evaluation Procedures for Operating Pressure Vessels, Tanks and Piping in Refinery and Chemical Service*

---

<sup>1</sup> ASM International, 9639 Kinsman Road, Materials Park, OH 44073-0002, [www.asminternational.org](http://www.asminternational.org)

<sup>2</sup> ASME International, 3 Park Avenue, New York, NY 10016-5990, [www.asme.org](http://www.asme.org)

<sup>3</sup> ASTM International, 100 Barr harbor Drive, West Conshohocken, PA 19428-2959, [www.astm.org](http://www.astm.org)

<sup>4</sup> British Standard Institute, 389 Chiswick High Road, London W44AL, United Kingdom, [www.bsi-global.com](http://www.bsi-global.com)

<sup>5</sup> Materials Properties Council, 3 Park Avenue, 27<sup>th</sup> Floor, New York, NY 10016-5902, [www.forengineers.org/mpc](http://www.forengineers.org/mpc)



NACE<sup>6</sup>

Std. MR 0103	<i>Materials Resistant to Sulfide Stress Cracking in Corrosive Petroleum Refining Environments</i>
RP 0169	<i>Standard Recommended Practice: Control of External Corrosion on Underground or Submerged Metallic Piping Systems</i>
RP 0170	<i>Protection of Austenitic Stainless Steels and Other Austenitic Alloys from Polythionic Acid Stress Corrosion Cracking during Shutdown of Refinery Equipment</i>
RP 0198	<i>The Control of Corrosion Under Thermal Insulation, and Fireproofing – A Systems Approach</i>
RP 0294	<i>Design, Fabrication, and Inspection of Tanks for the Storage of Concentrated Sulfuric Acid and Oleum at Ambient Temperatures</i>
RP 0296	<i>Guidelines for Detection, Repair and Mitigation of Cracking of Existing Petroleum Refinery Pressure Vessels in Wet H<sub>2</sub>S Environments</i>
SP 0472	<i>Methods and Controls to Prevent in-Service Environmental Cracking of Carbon Steel Weldments in Corrosive Petroleum Refining Environments</i>
SP0590	<i>Prevention, Detection, and Correction of Deaerator Cracking</i>
SP0403	<i>Avoiding Caustic Stress Corrosion Cracking of Carbon Steel Refinery Equipment and Piping</i>
Publ. 5A151	<i>Materials of Construction for Handling Sulfuric Acid</i>
Publ. 5A171	<i>Materials for Receiving, Handling and Storing Hydrofluoric Acid</i>
Publ. 8X194	<i>Materials and Fabrication Practices for New Pressure Vessels used in Wet H<sub>2</sub>S Refinery Service</i>
Publ. 34108	<i>Review and Survey of Alkaline Carbonate Stress Corrosion Cracking in Refinery Sour Water</i>
Publ.34105	<i>Effect of Nonextractable Chlorides on Refinery Corrosion and Fouling</i>

WRC<sup>7</sup>

Bulletin 32	<i>Graphitization of Steel in Petroleum Refining Equipment and the Effect of Graphitization of Steel on Stress-Rupture Properties</i>
Bulletin 275	<i>The Use of Quenched and Tempered 2-1/4Cr-1Mo Steel for Thick Wall Reactor Vessels in Petroleum Refinery Processes: An Interpretive Review of 25 Years of Research and Application</i>
Bulletin 350	<i>Design Criteria for Dissimilar Metal Welds</i>
Bulletin 409	<i>Fundamental Studies Of The Metallurgical Causes And Mitigation Of Reheat Cracking In 1¼Cr-½Mo And 2¼Cr-1Mo Steels</i>
Bulletin 418	<i>The Effect of Crack Depth (a) and Crack-Depth to Width Ratio (a/W) on the Fracture Toughness of A533-B Steel</i>
Bulletin 452	<i>Recommended Practices for Local Heating of Welds in Pressure Vessels</i>

<sup>6</sup> NACE International, 1440 South Creek Drive, Houston, TX 77084, [www.nace.org](http://www.nace.org)

<sup>7</sup> Welding Research Council, 3 Park Avenue, 27<sup>th</sup> Floor, New York, NY 10016-5902, [www.forengineers.org/wrc](http://www.forengineers.org/wrc)

**2.2 Other References**

A list of publications that offer background and other information pertinent to the damage mechanism is provided in the section covering each damage mechanism.

## SECTION 3

### DEFINITION OF TERMS AND ABBREVIATIONS

3.1	Terms .....	3-3
3.2	Symbols and Abbreviations.....	3-4

*This page intentionally left blank.*

### 3.1 Terms

**3.1.1 Austenitic** – a term that refers to a type of metallurgical structure (austenite) normally found in 300 Series stainless steels and nickel base alloys.

**3.1.2 Austenitic stainless steels** – the 300 Series stainless steels including Types 304, 304L, 304H, 309, 310, 316, 316L, 316H, 321, 321H, 347, and 347H. The “L” and “H” suffixes refer to controlled ranges of low and high carbon content, respectively. These alloys are characterized by an austenitic structure.

**3.1.3 Carbon steel** – steels that do not have alloying elements intentionally added. However, there may be small amounts of elements permitted by specifications such as SA516 and SA106, for example that can affect corrosion resistance, hardness after welding, and toughness. Elements which may be found in small quantities include Cr, Ni, Mo, Cu, S, Si, P, Al, V and B.

**3.1.4 Diethanolamine (DEA)** – used in amine treating to remove H<sub>2</sub>S and CO<sub>2</sub> from hydrocarbon streams.

**3.1.5 Duplex stainless steel** – a family of stainless steels that contain a mixed austenitic-ferritic structure including Alloy 2205, 2304, and 2507. The welds of 300 series stainless steels may also exhibit a duplex structure.

**3.1.6 Ferritic** – a term that refers to a type of metallurgical structure (ferrite) normally found in carbon and low alloy steels and many 400 series stainless steels.

**3.1.7 Ferritic stainless steels** – include Types 405, 409, 430, 442, and 446.

**3.1.8 Heat Affected Zone (HAZ)** – the portion of the base metal adjacent to a weld which has not been melted, but the metallurgical microstructure and mechanical properties have been changed by the heat of welding, sometimes with undesirable effects.

**3.1.9 High Strength low Alloy Steels (HSLA)** - A family of low-carbon steels in which the strength levels are achieved by the addition of moderate amounts of alloying elements such as titanium, vanadium or niobium in amounts of less than 0.1 per cent. They can be are more sensitive to cracking during fabrication from hydrogen embrittlement (delayed cracking) or underbead cracking.

**3.1.10 Hydrogen Induced Cracking (HIC)** – describes stepwise internal cracks that connect adjacent hydrogen blisters on different planes in the metal, or to the metal surface. No externally applied stress is needed for the formation of HIC. The development of internal cracks (sometimes referred to as blister cracks) tends to link with other cracks by a transgranular plastic shear mechanism because of internal pressure resulting from the accumulation of hydrogen. The link-up of these cracks on different planes in steels has been referred to as stepwise cracking to characterize the nature of the crack appearance.

**3.1.11 Low alloy steel** – a family of steels containing up to 9% chromium and other alloying additions for high temperature strength and creep resistance. The materials include C-0.5Mo, Mn-0.5Mo, 1Cr-0.5Mo, 1.25 Cr-0.5Mo, 2.25Cr-1.0Mo, 5Cr-0.5Mo, and 9Cr-1Mo. These are considered ferritic steels.

**3.1.12 Martensitic** – a term that refers to a type of metallurgical structure (martensite) normally found in some 400 series stainless steel. Heat treatment and or welding followed by rapid cooling can produce this structure in carbon and low alloy steels.

**3.1.13 Martensitic stainless steel** – include Types 410, 410S, 416, 420, 440A, 440B, and 440C.

**3.1.14 Methyldiethanolamine (MDEA)** – used in amine treating to remove H<sub>2</sub>S and CO<sub>2</sub> from hydrocarbon streams.

**3.1.15 Monoethanolamine (MEA)** – used in amine treating to remove H<sub>2</sub>S and CO<sub>2</sub> from hydrocarbon streams.

**3.1.16 Nickel base** – a family of alloys containing nickel as a major alloying element (>30%) including Alloys 200, 400, K-500, 800, 800H, 825, 600, 600H, 617, 625, 718, X-750, and C276.

**3.1.17 Stress oriented hydrogen induced cracking (SOHIC)** – describes an array of cracks, aligned nearly perpendicular to the stress, that are formed by the link-up of small HIC cracks in steel. Tensile strength (residual or applied) is required to produce SOHIC. SOHIC is commonly observed in the base metal adjacent to the Heat Affected Zone (HAZ) of a weld, oriented in the through-thickness direction. SOHIC may also be produced in susceptible steels at other high stress points, such as from the tip of the mechanical cracks and defects, or from the interaction among HIC on different planes in the steel.

**3.1.18 Stainless steel** – there are four categories of stainless steels that are characterized by their metallurgical structure at room temperature: austenitic, ferritic, martensitic and duplex. These alloys have varying amounts of chromium and other alloying elements that give them resistance to oxidation, sulfidation and other forms of corrosion depending on the alloy content.

## **3.2 Symbols and Abbreviations**

**3.2.1 ACFM** – alternating current field measurement.

**3.2.2 ASCC** – alkaline stress corrosion cracking.

**3.2.3 ACSCC** – alkaline carbonate stress corrosion cracking.

**3.2.4 AE** – acoustic emission.

**3.2.5 AET** – acoustic emission testing.

**3.2.6 AGO** – atmospheric gas oil.

**3.2.7 AUBT** – automated ultrasonic backscatter testing.

**3.2.8 BFW** – boiler feed water.

**3.2.9 C<sub>2</sub>** – chemical symbol referring to ethane or ethylene.

**3.2.10 C<sub>3</sub>** – chemical symbol referring to propane or propylene.

**3.2.11 C<sub>4</sub>** – chemical symbol referring to butane or butylenes.

**3.2.12 Cat** – catalyst or catalytic.

**3.2.13 CDU** – crude distillation unit.

**3.2.14 CH<sub>4</sub>** – methane.

**3.2.15 CO** – carbon monoxide.

- 
- 3.2.16 **CO<sub>2</sub>** – carbon dioxide.
  - 3.2.17 **CVN** – charpy v-notch.
  - 3.2.18 **CW** – cooling water.
  - 3.2.19 **DIB** – deisobutanizer.
  - 3.2.20 **DNB** – Departure from Nucleate Boiling.
  - 3.2.21 **DEA** – diethanolamine, used in amine treating to remove H<sub>2</sub>S and CO<sub>2</sub> from hydrocarbon streams.
  - 3.2.22 **EC** – eddy current, test method applies primarily to non-ferromagnetic materials.
  - 3.2.23 **FCC** – fluid catalytic cracker.
  - 3.2.24 **FMR** – field metallographic replication.
  - 3.2.25 **H<sub>2</sub>** – diatomic hydrogen.
  - 3.2.26 **H<sub>2</sub>O** – also known as water.
  - 3.2.27 **H<sub>2</sub>S** – hydrogen sulfide, a poisonous gas.
  - 3.2.28 **HAZ** – Heat Affected Zone
  - 3.2.29 **HB** – Brinnell hardness number.
  - 3.2.30 **HCO** – heavy cycle oil.
  - 3.2.31 **HCGO** – heavy coker gas oil.
  - 3.2.32 **HIC** – Hydrogen Induced Cracking
  - 3.2.33 **HP** – high pressure.
  - 3.2.34 **HPS** – high pressure separator.
  - 3.2.35 **HHPS** – hot high pressure separator.
  - 3.2.36 **HVGO** – heavy vacuum gas oil.
  - 3.2.37 **HSLA** – high strength low alloy.
  - 3.2.38 **HSAS** – heat stable amine salts.
  - 3.2.39 **IC<sub>4</sub>** – chemical symbol referring isobutane.
  - 3.2.40 **IP** – intermediate pressure.
  - 3.2.41 **IRIS** – internal rotating inspection system.
  - 3.2.42 **K.O.** – knock out, as in K.O. Drum.

- 3.2.43 **LCGO** – light coker gas oil.
- 3.2.44 **LCO** – light cycle oil.
- 3.2.45 **LP** – low pressure.
- 3.2.46 **LPS** – low pressure separator.
- 3.2.47 **LVGO** – light vacuum gas oil.
- 3.2.48 **MDEA** – methyldiethanolamine.
- 3.2.49 **MEA** – monoethanolamine.
- 3.2.50 **mpy** – mils per year.
- 3.2.51 **MT** – magnetic particle testing.
- 3.2.52 **NAC** – naphthenic acid corrosion.
- 3.2.53 **NH<sub>4</sub>HS** – ammonium bisulfide.
- 3.2.54 **PMI** – positive materials identification.
- 3.2.55 **PFD** – process flow diagram.
- 3.2.56 **PT** – liquid penetrant testing.
- 3.2.57 **RFEC** – remote field eddy current testing.
- 3.2.58 **RT** – radiographic testing.
- 3.2.59 **SCC** – stress corrosion cracking.
- 3.2.60 **SOHIC** – Stress Oriented Hydrogen Induced Cracking
- 3.2.61 **SS** – Stainless Steel.
- 3.2.62 **SW** – sour water.
- 3.2.63 **SWS** – sour water stripper.
- 3.2.64 **SWUT** – shear wave ultrasonic testing.
- 3.2.65 **Ti** – titanium.
- 3.2.66 **TOFD** – Time of flight diffraction
- 3.2.67 **UT** – ultrasonic testing.
- 3.2.68 **VDU** – vacuum distillation unit.
- 3.2.69 **VT** – visual inspection.
- 3.2.70 **WFMT** – wet fluorescent magnetic particle testing.



## SECTION 4

### GENERAL DAMAGE MECHANISMS – ALL INDUSTRIES

4.1	General.....	4-3
4.2	Mechanical and Metallurgical Failure Mechanisms.....	4-3
4.2.1	Graphitization .....	4-3
4.2.2	Softening (Spheroidization) .....	4-7
4.2.3	Temper Embrittlement .....	4-10
4.2.4	Strain Aging .....	4-14
4.2.5	885°F (475°C) Embrittlement .....	4-16
4.2.6	Sigma Phase Embrittlement.....	4-19
4.2.7	Brittle Fracture.....	4-27
4.2.8	Creep and Stress Rupture .....	4-32
4.2.9	Thermal Fatigue.....	4-39
4.2.10	Short Term Overheating – Stress Rupture .....	4-46
4.2.11	Steam Blanketing .....	4-51
4.2.12	Dissimilar Metal Weld (DMW) Cracking .....	4-54
4.2.13	Thermal Shock.....	4-63
4.2.14	Erosion/Erosion – Corrosion .....	4-65
4.2.15	Cavitation .....	4-70
4.2.16	Mechanical Fatigue .....	4-74
4.2.17	Vibration-Induced Fatigue .....	4-81
4.2.18	Refractory Degradation .....	4-84
4.2.19	Reheat Cracking .....	4-87
4.2.20	Gaseous Oxygen-Enhanced Ignition and Combustion.....	4-93
4.3	Uniform or Localized Loss of Thickness.....	4-101
4.3.1	Galvanic Corrosion .....	4-101
4.3.2	Atmospheric Corrosion .....	4-105
4.3.3	Corrosion Under Insulation (CUI) .....	4-108
4.3.4	Cooling Water Corrosion.....	4-117
4.3.5	Boiler Water Condensate Corrosion .....	4-120
4.3.6	CO <sub>2</sub> Corrosion.....	4-124
4.3.7	Flue-Gas Dew-Point Corrosion .....	4-128
4.3.8	Microbiologically Induced Corrosion (MIC).....	4-130
4.3.9	Soil Corrosion.....	4-136
4.3.10	Caustic Corrosion .....	4-140
4.3.11	Dealloying .....	4-143
4.3.12	Graphitic Corrosion .....	4-147
4.4	High Temperature Corrosion [ $>400^{\circ}\text{F}$ ( $204^{\circ}\text{C}$ )] .....	4-153
4.4.1	Oxidation .....	4-153
4.4.2	Sulfidation .....	4-159
4.4.3	Carburization .....	4-166
4.4.4	Decarburization .....	4-169
4.4.5	Metal Dusting.....	4-172
4.4.6	Fuel Ash Corrosion .....	4-175
4.4.7	Nitriding.....	4-180
4.5	Environment – Assisted Cracking.....	4-184
4.5.1	Chloride Stress Corrosion Cracking (CISCC).....	4-184
4.5.2	Corrosion Fatigue .....	4-193
4.5.3	Caustic Stress Corrosion Cracking (Caustic Embrittlement).....	4-199
4.5.4	Ammonia Stress Corrosion Cracking .....	4-206
4.5.5	Liquid Metal Embrittlement (LME) .....	4-210
4.5.6	Hydrogen Embrittlement (HE).....	4-215

<b>4.5.7</b>	<b>Ethanol Stress Corrosion Cracking .....</b>	<b>4-220</b>
<b>4.5.8</b>	<b>Sulfate Stress Corrosion Cracking.....</b>	<b>4-227</b>

## 4.1 General

Damage mechanisms that are common to a variety of industries including refining and petrochemical, pulp and paper, and fossil utility are covered in this Section. The mechanisms are divided into the following sections:

- a) Mechanical and Metallurgical Failure
- b) Uniform or Localized Loss of Thickness
- c) High Temperature Corrosion
- d) Environment Assisted Cracking

## 4.2 Mechanical and Metallurgical Failure Mechanisms

### 4.2.1 Graphitization

#### 4.2.1.1 Description of Damage

- a) Graphitization is a change in the microstructure of certain carbon steels and 0.5Mo steels after long-term operation in the 800°F to 1100°F (427°C to 593°C) range that may cause a loss in strength, ductility, and/or creep resistance.
- b) At elevated temperatures, the carbide phases in these steels are unstable and may decompose into graphite nodules. This decomposition is known as graphitization.

#### 4.2.1.2 Affected Materials

Some grades of carbon steel and 0.5Mo steels.

#### 4.2.1.3 Critical Factors

- a) The most important factors that affect graphitization are the chemistry, stress, temperature, and time of exposure.
- b) In general, graphitization is not commonly observed. Some steels are much more susceptible to graphitization than others, but exactly what causes some steels to graphitize while others are resistant is not well understood. It was originally thought that silicon and aluminum content played a major role but it has been shown that they have negligible influence on graphitization.
- c) Graphitization has been found in low alloy C-Mo steels with up to 1% Mo. The addition of about 0.7% chromium has been found to eliminate graphitization.
- d) Temperature has an important effect on the rate of graphitization. Below 800°F (427°C), the rate is extremely slow. The rate increases with increasing temperature.
- e) There are two general types of graphitization. First is random graphitization in which the graphite nodules are distributed randomly throughout the steel. While this type of graphitization may lower the room-temperature tensile strength, it does not usually lower the creep resistance.

- f) The second and more damaging type of graphitization results in chains or local planes of concentrated graphite nodules. This form of graphitization can result in a significant reduction in load bearing capability while increasing the potential for brittle fracture along this plane. The two forms of this type of graphitization are weld heat-affected zone graphitization and non-weld graphitization.
- 1) Weld heat-affected zone graphitization is most frequently found in the heat-affected zone adjacent to welds in a narrow band, corresponding to the low temperature edge of the heat-affected zone. In multipass welded butt joints, these zones overlap each other, covering the entire cross-section. Graphite nodules can form at the low temperature edge of these heat-affected zones, resulting in a band of weak graphite extending across the section. Because of its appearance, this graphite formation within heat-affected zones is called eyebrow graphitization.
  - 2) Non-weld graphitization is a form of localized graphitization that sometimes occurs along planes of localized yielding in steel. It also occurs in a chain-like manner in regions that have experienced significant plastic deformation as a result of cold working operations or bending.
- g) The extent and degree of graphitization is usually reported in a qualitative fashion (none, slight, moderate, severe). Although it is difficult to predict the rate at which it forms, severe heat-affected zone graphitization can develop in as little as five years at service temperatures above 1000°F (538°C). Very slight graphitization would be expected to be found after 30 to 40 years at 850°F (454°C). Time-Temperature-Transformation curves for heat-affected zone graphitization can be found in Reference 2.

#### **4.2.1.4 Affected Units or Equipment**

- a) Primarily hot-wall piping and equipment in the FCC, catalytic reforming and coker units.
- b) Bainitic grades are less susceptible than coarse pearlitic grades.
- c) Few failures directly attributable to graphitization have been reported in the refining industry. However, graphitization has been found where failure resulted primarily from other causes.
- d) Several serious cases of graphitization have occurred in the reactors and piping of fluid catalytic cracking units, as well as with carbon steel furnace tubes in a thermal cracking unit and the failure of seal welds at the bottom tube sheet of a vertical waste heat boiler in a fluid catalytic cracker. A graphitization failure was reported in the long seam weld of a C-0.5Mo catalytic reformer reactor/interheater line.
- e) Where concentrated eyebrow graphitization occurs along heat-affected zones, the creep rupture strength may be drastically lowered. Slight to moderate amounts of graphite along the heat-affected zones do not appear to significantly lower room or high-temperature properties.
- f) Graphitization seldom occurs on boiling surface tubing but did occur in low alloy C-0.5Mo tubes and headers during the 1940's. Economizer tubing, steam piping and other equipment that operates in the range of temperatures of 850°F to 1025°F (441°C to 552°C) is more likely to suffer graphitization.

#### **4.2.1.5 Appearance or Morphology of Damage**

- a) Damage due to graphitization is not visible or readily apparent and can only be observed by metallographic examination ([Figure 4-1](#) and [Figure 4-2](#)).
- b) Advanced stages of damage related to loss in creep strength may include microfissuring/microvoid formation, subsurface cracking or surface connected cracking.

#### **4.2.1.6 Prevention / Mitigation**

Graphitization can be prevented by using chromium containing low alloy steels for long-term operation above 800°F (427°C).

#### **4.2.1.7 Inspection and Monitoring**

- a) Evidence of graphitization is most effectively evaluated through removal of full thickness samples for examination using metallographic techniques. Damage may occur midwall so that field replicas may be inadequate.
- b) Advanced stages of damage related to loss in strength include surface breaking cracks or creep deformation that may be difficult to detect.

#### **4.2.1.8 Related Mechanisms**

Spheroidization (see 4.2.2) and graphitization are competing mechanisms that occur at overlapping temperature ranges. Spheroidization tends to occur preferentially above 1025°F (551°C), while graphitization predominates below this temperature.

#### **4.2.1.9 References**

1. H. Thielsch, "Defects and Failures in Pressure Vessels and Piping," Rheinhold Publishing Co., New York, 1965, pp. 49-83.
2. J.R. Foulds and R. Viswanathan, "Graphitization of Steels in Elevated-Temperature Service," Proceedings of the First International Symposium: Microstructures and Mechanical Properties of Aging Materials, November, 1992.
3. R.D. Port, "Non-Weld Related Graphitization Failures," CORROSION/89, Paper #248, (Houston: NACE 1989).
4. ASM Metals Handbook, "Properties and Selection: Iron, Steels, and High-Performance Alloys," Volume 1, ASM International, Materials Park, OH.
5. D.N. French, "Microstructural Degradation," The National Board of Boiler and Pressure Vessel Inspectors, <http://www.nationalboard.com>, June 2001.
6. Joseph G. Wilson, "Graphitization of Steel in Petroleum Refining Equipment and the Effect of Graphitization of Steel on Stress-Rupture Properties," WRC Bulletin Series, No.32, Shaker Heights, OH, January, 1957.
7. J. D Dobis and L. Huang, "Assessment of Graphitized Carbon Steel Tubes in Fired Heater Service," CORROSION/05, NACE International, paper #05559, Houston, TX, 2005.

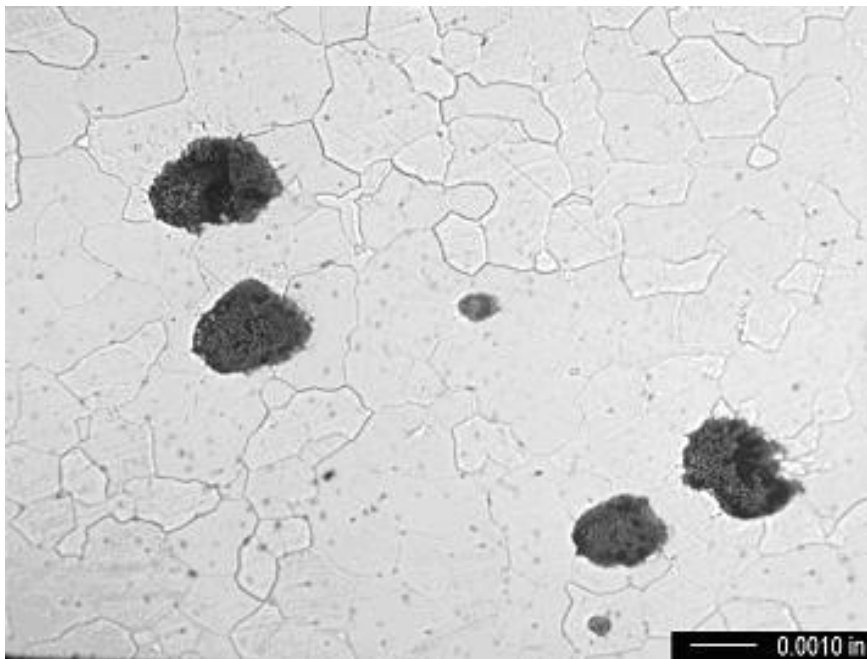


Figure 4-1 – High magnification photomicrograph of metallographic sample showing graphite nodules. Compare to normal microstructure shown in Figure 4-2.

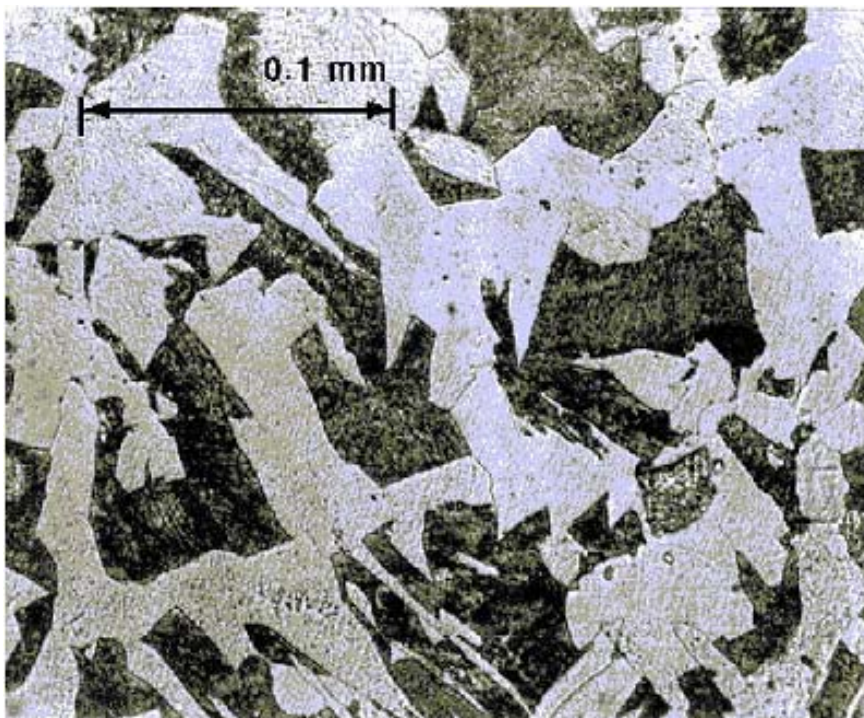


Figure 4-2 – High magnification photomicrograph of metallographic sample showing typical ferrite-pearlite structure of carbon steel.

## 4.2.2 Softening (Spheroidization)

### 4.2.2.1 Description of Damage

Spheroidization is a change in the microstructure of steels after exposure in the 850°F to 1400°F (440°C to 760°C) range, where the carbide phases in carbon steels are unstable and may agglomerate from their normal plate-like form to a spheroidal form, or from small, finely dispersed carbides in low alloy steels like 1Cr-0.5Mo to large agglomerated carbides. Spheroidization may cause a loss in strength and/or creep resistance.

### 4.2.2.2 Affected Materials

All commonly used grades of carbon steel and low alloy steels including C-0.5Mo, 1Cr-0.5Mo, 1.25Cr-0.5Mo, 2.25Cr-1Mo, 3Cr-1Mo, 5Cr-0.5Mo, and 9Cr-1Mo steels.

### 4.2.2.3 Critical Factors

- a) Metal chemistry, microstructure, exposure time, and temperature are critical factors.
- b) The rate of spheroidization depends on the temperature and initial microstructure. Spheroidization can occur in a few hours at 1300°F (552°C), but may take several years at 850°F (454°C).
- c) Annealed steels are more resistant to spheroidization than normalized steels. Coarse-grained steels are more resistant than fine-grained. Fine grained silicon-killed steels are more resistant than aluminum-killed.

### 4.2.2.4 Affected Units or Equipment

- a) Spheroidization can occur in piping and equipment after exposure to temperatures above 850°F (454°C). The loss in strength may be as high as about 30% but failure is not likely to occur except under very high applied stresses, in areas of stress concentration, or in combination with other damage mechanisms.
- b) The loss in strength is usually accompanied by an increase in ductility which allows for deformation at stress concentrations.
- c) Spheroidization affects hot wall piping and equipment in the FCC, catalytic reforming and coker units. Fired heater tubes in boilers or process units may be affected by a loss in creep strength, but equipment, in general, is seldom renewed or repaired because of spheroidization.

### 4.2.2.5 Appearance or Morphology of Damage

- a) Spheroidization is not visible or readily apparent and can only be observed through metallography. The pearlitic phase undergoes a time dependant transformation from partial to complete spheroidization (Figure 4-3 and Figure 4-4).
- b) In the case of the 5% to 9% CrMo alloys, spheroidization is the process of transforming the carbides from their original finely dispersed morphology to large agglomerated carbides.

### 4.2.2.6 Prevention / Mitigation

Spheroidization is difficult to prevent except by minimizing long-term exposure to elevated temperatures.

### 4.2.2.7 Inspection and Monitoring

Spheroidization can only be found through field metallography or removal of samples for metallographic observation. A reduction in tensile strength and/or hardness may indicate a spheroidized microstructure.

**4.2.2.8 Related Mechanisms**

- a) Closely related to graphitization (see 4.2.1).
- b) Spheroidization and graphitization are competing mechanisms which occur at overlapping temperature ranges. At temperatures above about 1025°F (552°C), graphitization may occur after spheroidization. Below 1025°F (552°C), graphitization occurs before the steel is fully spheroidized.

**4.2.2.9 References**

1. ASM Metals Handbook, "Properties and Selection: Iron, Steels, and High-Performance Alloys," Volume 1, ASM International, Materials Park, OH.
2. D.N. French, "Microstructural Degradation," The National Board of Boiler and Pressure Vessel Inspectors, <http://www.nationalboard.com>, June 2001.
3. R. D. Port, "Non-Weld Related Graphitization Failures," CORROSION/89, Paper #248, Houston, TX, NACE 1989.



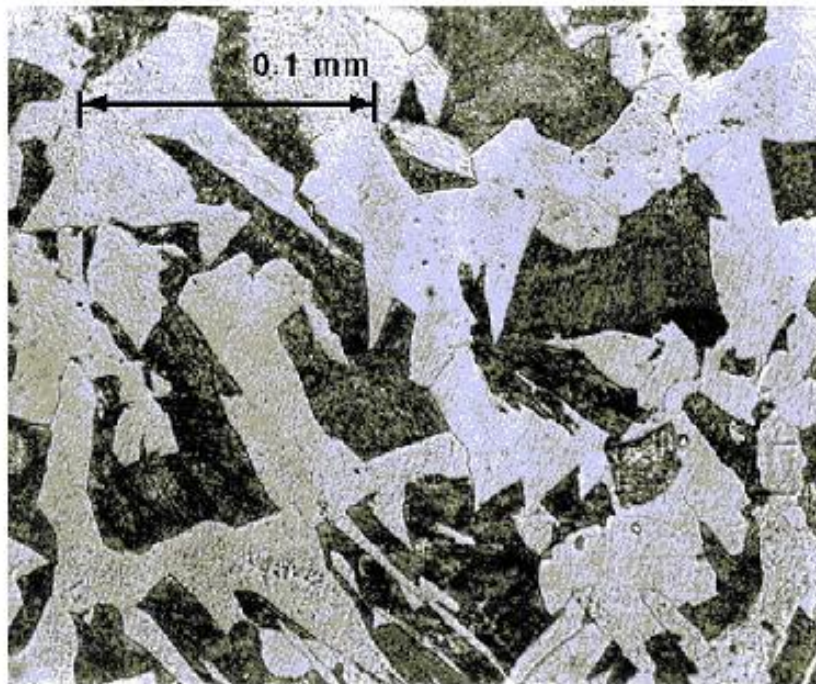


Figure 4-3 – High magnification photomicrograph of metallographic sample showing typical ferrite-pearlite structure of carbon steel.

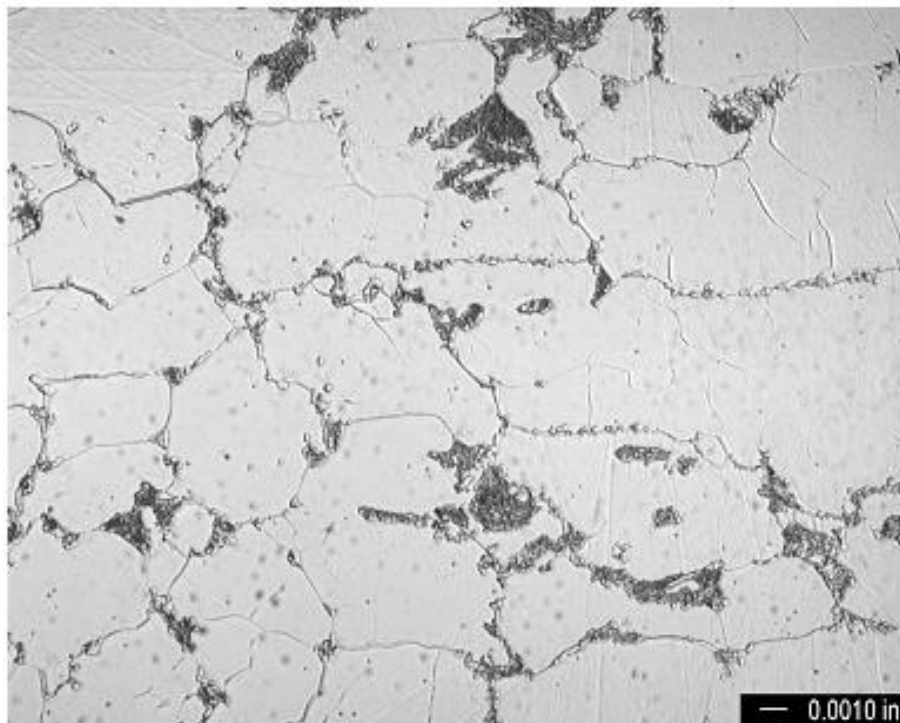


Figure 4-4 – High magnification photomicrograph of metallographic sample showing spheroidized carbides.

### 4.2.3 Temper Embrittlement

#### 4.2.3.1 Description of Damage

Temper embrittlement is the reduction in toughness due to a metallurgical change that can occur in some low alloy steels as a result of long term exposure in the temperature range of about 650°F to 1070°F (343°C to 577°C). This change causes an upward shift in the ductile-to-brittle transition temperature as measured by Charpy impact testing. Although the loss of toughness is not evident at operating temperature, equipment that is temper embrittled may be susceptible to brittle fracture during start-up and shutdown.

#### 4.2.3.2 Affected Materials

- a) Primarily 2.25Cr-1Mo low alloy steel, 3Cr-1Mo (to a lesser extent), and the high-strength low alloy Cr-Mo-V rotor steels.
- b) Older generation 2.25Cr-1Mo materials manufactured prior to 1972 may be particularly susceptible. Some high strength low alloy steels are also susceptible.
- c) The C-0.5Mo, 1Cr-0.5Mo and 1.25Cr-0.5Mo alloy steels are not significantly affected by temper embrittlement. However, other high temperature damage mechanisms promote metallurgical changes that can alter the toughness or high temperature ductility of these materials. Refer to API 934-C and API 934-D for additional information.
- d) Weld materials are generally more affected than today's low-impurity base materials.

#### 4.2.3.3 Critical Factors

- a) Alloy steel composition, thermal history, metal temperature and exposure time are critical factors.
- b) Susceptibility to temper embrittlement is largely determined by the presence of the alloying elements manganese and silicon, and the tramp elements phosphorus, tin, antimony, and arsenic. The strength level and heat treatment/fabrication history should also be considered.
- c) Temper embrittlement of 2.25Cr-1Mo steels develops more quickly at 900°F (482°C) than in the 800°F to 850°F (427°C to 440°C) range, but the damage is more severe after long-term exposure at 850°F (440°C).
- d) Some embrittlement can occur during fabrication heat treatments, but most of the damage occurs over many years of service in the embrittling temperature range.
- e) This form of damage will significantly reduce the structural integrity of a component containing a crack-like flaw. An evaluation of the materials toughness may be required depending on the flaw type, the severity of the environment, and the operating conditions, particularly in hydrogen service.

#### 4.2.3.4 Affected Units or Equipment

- a) Temper embrittlement occurs in a variety of process units after long term exposure to temperatures above 650°F (343°C). It should be noted that there have been very few industry failures related directly to temper embrittlement.
- b) Equipment susceptible to temper embrittlement is most often found in hydroprocessing units, particularly reactors, hot feed/effluent exchanger components, and hot HP separators. Other units with the potential for temper embrittlement include catalytic reforming units (reactors and exchangers), FCC reactors, coker and visbreaking units.
- c) Welds in these alloys are often more susceptible than the base metal and should be evaluated.

#### 4.2.3.5 Appearance or Morphology of Damage

- a) Temper embrittlement is a metallurgical change that is not readily apparent and can be confirmed through impact testing. Damage due to temper embrittlement may result in catastrophic brittle fracture.
- b) Temper embrittlement can be identified by an upward shift in the ductile-to-brittle transition temperature measured in a Charpy V-notch impact test, as compared to the non-embrittled or de-embrittled material (Figure 4-5). Another important characteristic of temper embrittlement is that there is no effect on the upper shelf energy.
- c) SEM fractographs of severely temper embrittled material show primarily intergranular cracking due to impurity segregation at grain boundaries.

#### 4.2.3.6 Prevention / Mitigation

- a) Existing Materials
  - 1) Temper embrittlement cannot be prevented if the material contains critical levels of the embrittling impurity elements and is exposed in the embrittling temperature range.
  - 2) To minimize the possibility of brittle fracture during startup and shutdown, many refiners use a pressurization sequence to limit system pressure to about 25 percent of the maximum design pressure for temperatures below a Minimum Pressurization Temperature (MPT). Note that MPT is not a single point but rather a pressure-temperature envelope which defines safe operating conditions to minimize the likelihood of brittle fracture.
  - 3) MPT's generally range from 350°F (171°C) for the earliest, most highly temper embrittled steels, down to 125°F (52°C) or lower for newer, temper embrittlement resistant steels (as required to also minimize effects of hydrogen embrittlement).
  - 4) If weld repairs are required, the effects of temper embrittlement can be temporarily reversed (de-embrittled) by heating at 1150°F (620°C) for two hours per inch of thickness, and rapidly cooling to room temperature. It is important to note that re-embrittlement will occur over time if the material is re-exposed to the embrittling temperature range.
- b) New Materials
  - 1) The best way to minimize the likelihood and extent of temper embrittlement is to limit the acceptance levels of manganese, silicon, phosphorus, tin, antimony, and arsenic in the base metal and welding consumables. In addition, strength levels and PWHT procedures should be specified and carefully controlled.
  - 2) A common way to minimize temper embrittlement is to limit the "J\*" Factor for base metal and the "X" Factor for weld metal, based on material composition as follows:
 
$$J^* = (Si + Mn) \times (P + Sn) \times 10^4 \quad \{\text{elements in wt}\%$$

$$X = (10P + 5Sb + 4Sn + As)/100 \quad \{\text{elements in ppm}\}$$
  - 3) Typical J\* and X factors used for 2.25 Cr steel are a maximum of 100 and 15, respectively. Studies have also shown that limiting the (P + Sn) to less than 0.01% is sufficient to minimize temper embrittlement because (Si + Mn) control the rate of embrittlement.
  - 4) A newer and less widely used factor called the Equivalent Phosphorus content has been developed for base metal and weld metal and is defined as follows is given by:
 
$$P = C + Mn + (Mo Cr) / 3 + Si / 4 + 3.5 \times [(10 \times P + (5 \times Sb) + (4 \times Sn) + As) \quad \{\text{elements in wt}\%$$

- 5) Expert metallurgical advice should be solicited to determine acceptable composition, toughness and strength levels, as well as appropriate welding, fabricating and heat treating procedures for new low alloy steel heavy wall equipment and low alloy equipment operating in the temper embrittlement and/or creep range.

#### **4.2.3.7 Inspection and Monitoring**

- a) A common method of monitoring is to install blocks of original heats of the alloy steel material inside the reactor. Samples are periodically removed from these blocks for impact testing to monitor/establish the ductile-brittle transition temperature. The test blocks should be strategically located near the top and bottom of the reactor to make sure that the test material is exposed to both inlet and outlet conditions.
- b) Process conditions should be monitored to ensure that a proper pressurization sequence is followed to help prevent brittle fracture due to temper embrittlement.

#### **4.2.3.8 Related Mechanisms**

Not applicable.

#### **4.2.3.9 References**

1. R.A. Swift , "Temper Embrittlement in Low Alloy Ferritic Steels," CORROSION/76, Paper #125, NACE, 1976.
2. R.A. White and E.F. Ehmke, "Materials Selection for Refineries and Associated Facilities," National Association of Corrosion Engineers, NACE, 1991, pp. 53-54.
3. R. Viswanathan, "Damage Mechanisms and Life Assessment of High Temperature Components," ASM International, 1989.
4. API RP934-A, Materials and Fabrication Requirements for 2-1/4Cr-1Mo, 2-1/4Cr-1Mo-1/4V, 3Cr-1Mo and 3Cr-1Mo-1/4V Steel Heavy Wall Pressure Vessels for High Temperature, High Pressure Service, American Petroleum Institute, Washington, D.C, May 2008.
5. API RP934-B, Fabrication Considerations for 1/4V Steel Heavy Wall Pressure Vessels for High Temperature, High Pressure Hydrogen Service, American Petroleum Institute, Washington, D.C
6. API RP934-C, Materials and Fabrication Requirements for 1 1/4Cr-1/2Mo Steel Heavy Wall Pressure Vessels for High Temperature, High Pressure Hydrogen Service, American Petroleum Institute, Washington, D.C,.
7. API RP934-D, Technical Report on the Materials and Fabrication Issues of 1 1/4 Cr - 1/2 Mo and 1 Cr - 1/2 Mo Steel Pressure Vessels, American Petroleum Institute, Washington, D.C,.
8. API RP 934-E, RP for Materials and Fabrication of 1 1/4Cr-1/2Mo Steel Pressure Vessels for Service above 825°F (441°C), American Petroleum Institute, Washington, D.C, .
9. S. Pillot et al., "Effect of ageing and hydrogen on fracture mechanics and CVN properties of 2.25Cr-1Mo steel grades – application to MPT issues", NACE International, paper #009341, Houston, TX, 2005.

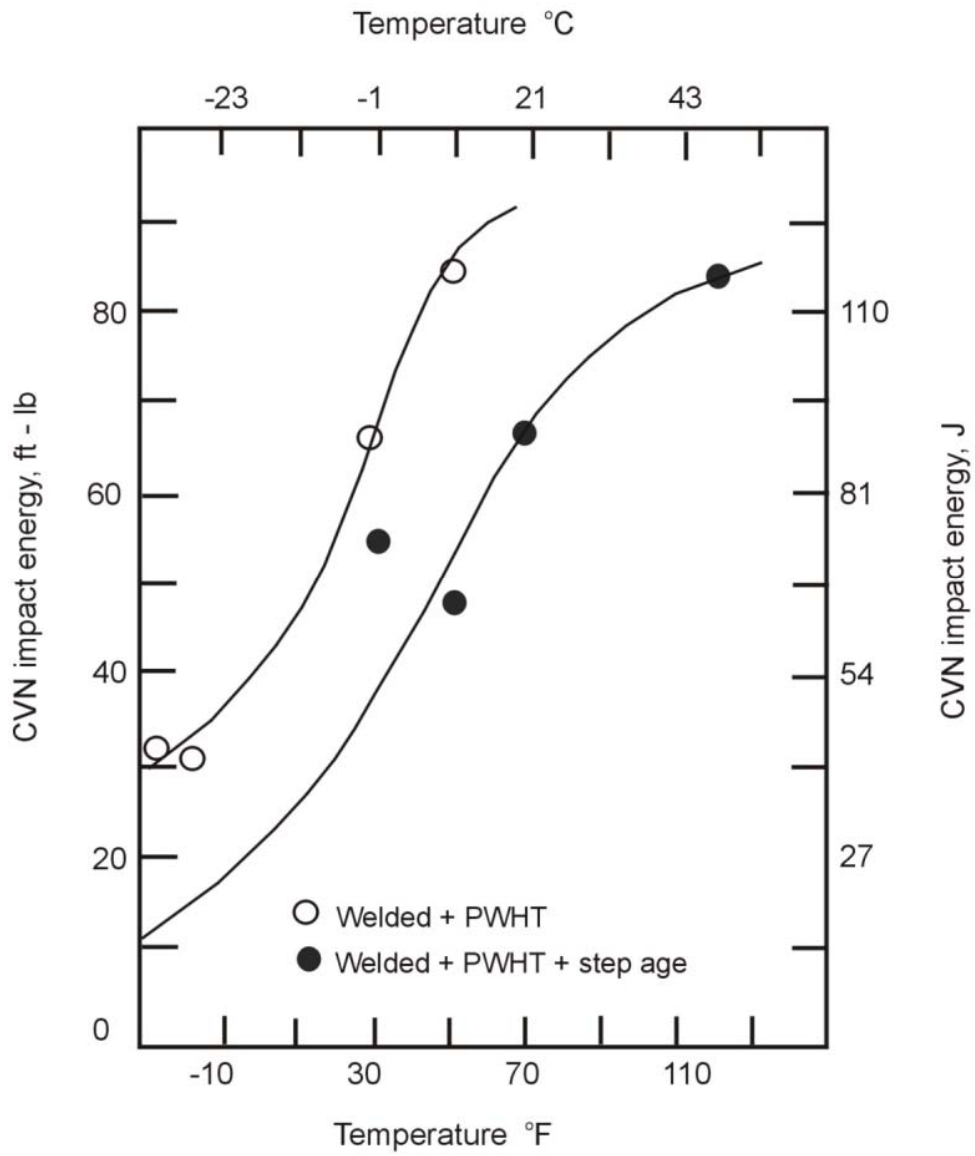


Figure 4-5 – Plot of CVN toughness as a function of temperature showing a shift in the 40-ft-lb transition temperature.

## 4.2.4 Strain Aging

### 4.2.4.1 *Description of Damage*

Strain aging is a form of damage found mostly in older vintage carbon steels and C-0.5 Mo low alloy steels under the combined effects of deformation and aging at an intermediate temperature. This results in an increase in hardness and strength with a reduction in ductility and toughness.

### 4.2.4.2 *Affected Materials*

Mostly older (pre-1980's) carbon steels with a large grain size and C-0.5 Mo low alloy steel.

### 4.2.4.3 *Critical Factors*

- a) Steel composition and manufacturing process determine steel susceptibility.
- b) Steels manufactured by the Bessemer or open hearth process contain higher levels of critical impurity elements than newer steels manufactured by the Basic Oxygen Furnace (BOF) process.
- c) In general, steels made by BOF and fully killed with aluminum will not be susceptible. The effect is found in rimmed and capped steels with higher levels of nitrogen and carbon, but not in the modern fully killed carbon steels manufactured to a fine grain practice.
- d) Strain aging effects are observed in materials that have been cold worked and placed into service at intermediate temperatures without stress relieving.
- e) Strain aging is a major concern for equipment that contains cracks. If susceptible materials are plastically deformed and exposed to intermediate temperatures, the zone of deformed material may become hardened and less ductile. This phenomenon has been associated with several vessels that have failed by brittle fracture.
- f) The pressurization sequence versus temperature is a critical issue to prevent brittle fracture of susceptible materials.
- g) Strain aging can also occur when welding in the vicinity of cracks and notches in a susceptible material.

### 4.2.4.4 *Affected Units or Equipment*

Strain aging is most likely to occur in thick wall vessels manufactured from susceptible materials that have not been stress relieved.

### 4.2.4.5 *Appearance or Morphology of Damage*

Strain aging can result in the formation of brittle cracks that are revealed through detailed metallurgical analyses, but damage most likely will not be identified as strain aging until fracture has already occurred.

### 4.2.4.6 *Prevention / Mitigation*

- a) Strain aging is not an issue for newer steels that contain low levels of interstitial impurity elements and sufficient aluminum (>0.015 wt%) to fully deoxidize the steel.
- b) For older equipment, extra care should be taken to avoid the potentially damaging effects of strain aging by avoiding stressing or pressurizing equipment until the metal temperature reaches an acceptable level where the risk of brittle fracture is low. Refer to curve "A" in UCS 66 of the ASME Code Section VIII, Division I for pressurization temperatures of vessels susceptible to strain aging effects.
- c) Applying PWHT to weld repairs of susceptible materials will eliminate the effects of strain aging. Where PWHT is not possible, buttering should be considered to minimize welding on old material under restraint.

**4.2.4.7    *Inspection and Monitoring***

Inspection and monitoring are not used to control strain aging.

**4.2.4.8    *Related Mechanisms***

When deformation occurs at the intermediate temperature, the mechanism is referred to as dynamic strain aging. Blue brittleness is another form of strain aging.

**4.2.4.9    *References***

1. ASME Boiler and Pressure Vessel Code, Section VIII, Division I, American Society of Mechanical Engineers, NY.

## **4.2.5 885°F (475°C) Embrittlement**

### **4.2.5.1 Description of Damage**

885°F (475°C) embrittlement is a loss in toughness due to a metallurgical change that can occur in alloys containing a ferrite phase, as a result of exposure in the temperature range 600°F to 1000°F (316°C to 540°C).

### **4.2.5.2 Affected Materials**

- a) 400 Series SS (e.g., 405, 409, 410, 410S, 430 and 446).
- b) Duplex stainless steels such as Alloys 2205, 2304 and 2507.

### **4.2.5.3 Critical Factors**

- a) The alloy composition, particularly chromium content, amount of ferrite phase, and operating temperature are critical factors.
- b) Increasing amounts of ferrite phase increase susceptibility to damage when operating in the high temperature range of concern. A dramatic increase in the ductile-to-brittle transition temperature will occur.
- c) A primary consideration is operating time at temperature within the critical temperature range. Damage is cumulative and results from the precipitation of an embrittling intermetallic phase that occurs most readily at approximately 885°F (475°C). Additional time is required to reach maximum embrittlement at temperatures above or below 885°F (475°C). For example, many thousands of hours may be required to cause embrittlement at 600°F (316°C).
- d) Since 885°F embrittlement can occur in a relatively short period of time, it is often assumed that susceptible materials that have been exposed to temperatures in the 700°F to 1000°F (371°C to 538°C) range are affected.
- e) The effect on toughness is not pronounced at the operating temperature, but is significant at lower temperatures experienced during plant shutdowns, startups or upsets.
- f) Embrittlement can result from tempering at higher temperatures or by holding within or cooling through the transformation range.

### **4.2.5.4 Affected Units or Equipment**

- a) 885°F embrittlement can be found in any unit where susceptible alloys are exposed to the embrittling temperature range.
- b) Most refining companies limit the use of ferritic stainless steels to non-pressure boundary applications because of this damage mechanism.
- c) Common examples include fractionator trays and internals in high temperature vessels used in FCC, crude, vacuum and coker units. Typical failures include cracking when attempting to weld or to straighten bent, upset tower trays of Type 409 and 410 material (occurs often with vacuum tower trays of this material).
- d) Other examples include duplex stainless steel heat exchanger tubes and other components exposed to temperatures above 600°F (316°C) for extended time periods.



#### **4.2.5.5 Appearance or Morphology of Damage**

- a) 885°F embrittlement is a metallurgical change that is not readily apparent with metallography but can be confirmed through bend or impact testing (Figure 4-6).
- b) The existence of 885°F embrittlement can be identified by an increase in hardness in affected areas. Failure during bend testing or impact testing of samples removed from service is the most positive indicator of 885°F embrittlement.

#### **4.2.5.6 Prevention / Mitigation**

- a) The best way to prevent 885°F embrittlement is to use low ferrite or non-ferritic alloys, or to avoid exposing the susceptible material to the embrittling range.
- b) It is possible to minimize the effects of embrittlement through modifications in the chemical composition of the alloy, however, resistant material may not always be readily available in most commercial forms.
- c) 885°F embrittlement is reversible by heat treatment to dissolve precipitates, followed by rapid cooling. The de-embrittling heat treatment temperature is typically 1100°F (593°C) or higher and may not be practical for many equipment items. If the de-embrittled component is exposed to the same service conditions it will re-embrittle faster than it did initially.

#### **4.2.5.7 Inspection and Monitoring**

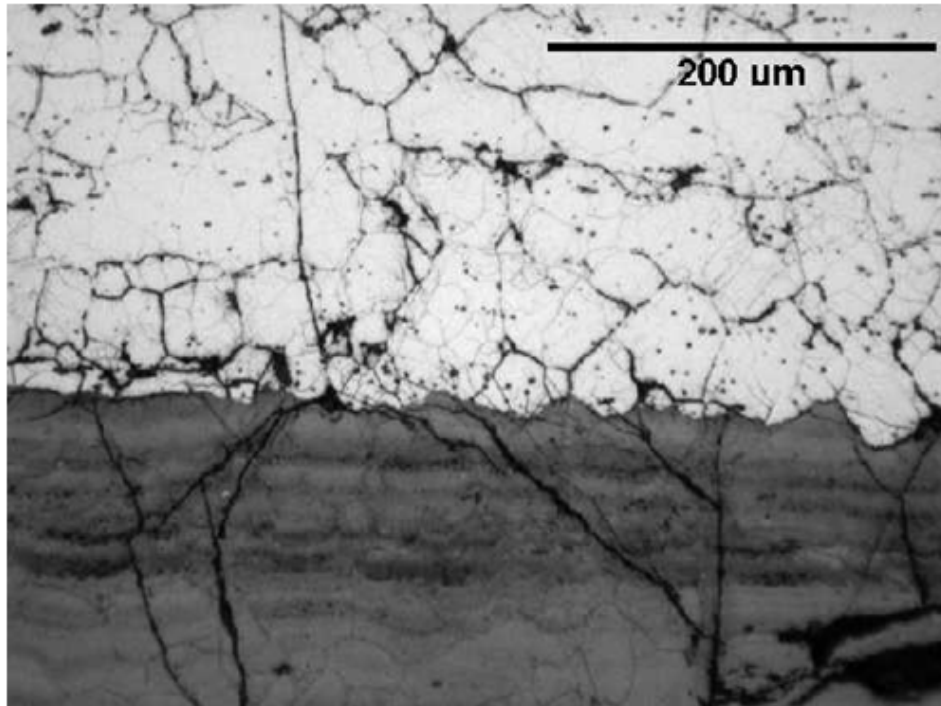
- a) Impact or bend testing of samples removed from service is the most positive indicator of a problem.
- b) Most cases of embrittlement are found in the form of cracking during turnarounds, or during startup or shutdown when the material is below about 200°F (93°C) and the effects of embrittlement are most detrimental.
- c) An increase in hardness is another method of evaluating 885°F embrittlement.

#### **4.2.5.8 Related Mechanisms**

Not applicable.

#### **4.2.5.9 References**

1. "High Temperature Characteristics of Stainless Steels," A Designers Handbook Series, American Iron and Steel Institute, Washington, DC, 1979.
2. G. E. Moller, "Experiences With 885°F (475°C) Embrittlement in Ferritic Stainless Steels," Materials Protection, NACE International, May, 1966.



**Figure 4-6 – Sample of cracked material with craze cracks running through the grains suggesting severe embrittlement.**

## 4.2.6 Sigma Phase Embrittlement

### 4.2.6.1 Description of Damage

Formation of a metallurgical phase known as sigma phase can result in a loss of fracture toughness in some stainless steels as a result of high temperature exposure.

### 4.2.6.2 Affected Materials

- a) 300 Series SS wrought metals, weld metal, and castings. Cast 300 Series SS including the HK and HP alloys are especially susceptible to sigma formation because of their high (10% to 40%) ferrite content.
- b) The 400 Series SS and other ferritic and martensitic SS with 17% Cr or more are also susceptible (e.g., Types 430 and 440).
- c) Duplex stainless steels.

### 4.2.6.3 Critical Factors

- a) Alloy composition, time and temperature are the critical factors.
- b) In susceptible alloys, the primary factor that affects sigma phase formation is the time of exposure at elevated temperature.
- c) Sigma phase occurs in ferritic (Fe-Cr), martensitic (Fe-Cr), austenitic (Fe-Cr-Ni) and duplex stainless steels when exposed to temperatures in the range of 1000°F to 1700°F (538°C to 927°C). Embrittlement can result by holding within or cooling through the transformation range.
- d) Sigma forms most rapidly from the ferrite phase that exists in 300 Series SS and duplex SS weld deposits. It can also form in the 300 Series SS base metal (austenite phase) but usually more slowly.
- e) The 300 Series SS can exhibit about 10% to 15% sigma phase. Cast austenitic stainless steels can develop considerably more sigma.
- f) Formation of sigma phase in austenitic stainless steels can also occur in a few hours, as evidenced by the known tendency for sigma to form if an austenitic stainless steel is subjected to a post weld heat treatment at 1275°F (690°C).
- g) The tensile and yield strength of sigmatized stainless steels increases slightly compared with solution annealed material. This increase in strength is accompanied by a reduction in ductility (measured by percent elongation and reduction in area) and a slight increase in hardness.
- h) Stainless steels with sigma can normally withstand normal operating stresses, but upon cooling to temperatures below about 500°F (260°C) may show a complete lack of fracture toughness as measured in a Charpy impact test. Laboratory tests of embrittled weld metal have shown a complete lack of fracture toughness below 1000°F (538°C)
- i) The metallurgical change is actually the precipitation of a hard, brittle intermetallic compound that can also render the material more susceptible to intergranular corrosion. The precipitation rate increases with increasing chromium and molybdenum content.

### 4.2.6.4 Affected Units or Equipment

- a) Common examples include stainless steel cyclones, piping ductwork and valves in high temperature FCC Regenerator service.
- b) 300 Series SS weld overlays and tube-to-tubesheet attachment welds can be embrittled during PWHT treatment of the underlying CrMo base metal.
- c) Stainless steel heater tubes are susceptible and can be embrittled.

**4.2.6.5 Appearance or Morphology of Damage**

- a) Sigma phase embrittlement is a metallurgical change that is not readily apparent, and can only be confirmed through metallographic examination and impact testing. (Tables 4-1 and 4-2)
- b) Damage due to sigma phase embrittlement appears in the form of cracking, particularly at welds or in areas of high restraint.
- c) Tests performed on sigmatized 300 Series SS (304H) samples from FCC regenerator internals have shown that even with 10% sigma formation, the Charpy impact toughness was 39 ft-lbs (53 J) at 1200°F (649°C).
- d) For the 10% sigmatized specimen, the values ranged from 0% ductility at room temperature to 100% at 1200°F (649°C). Thus, although the impact toughness is reduced at high temperature, the specimens broke in a 100% ductile fashion, indicating that the wrought material is still suitable at operating temperatures. See Figures 4-7 to 4-11.
- e) Cast austenitic stainless steels typically have high ferrite/sigma content (up to 40%) and may have very poor high temperature ductility.

**4.2.6.6 Prevention / Mitigation**

- a) The best way to prevent sigma phase embrittlement is to use alloys that are resistant to sigma formation or to avoid exposing the material to the embrittling range.
- b) The lack of fracture ductility at room temperature indicates that care should be taken to avoid application of high stresses to sigmatized materials during shutdown, as a brittle fracture could result.
- c) The 300 Series SS can be de-sigmatized by solution annealing at 1950°F (1066°C) for four hours followed by a water quench. However, this is not practical for most equipment.
- d) Sigma phase in welds can be minimized by controlling ferrite in the range of 5% to 9% for Type 347 and somewhat less ferrite for Type 304. The weld metal ferrite content should be limited to the stated maximum to minimize sigma formation during service or fabrication, and must meet the stated minimum in order to minimize hot short cracking during welding.
- e) For stainless steel weld overlay clad Cr-Mo components, the exposure time to PWHT temperatures should be limited wherever possible.

**4.2.6.7 Inspection and Monitoring**

- a) Physical testing of samples removed from service is the most positive indicator of a problem.
- b) Most cases of embrittlement are found in the form of cracking in both wrought and cast (welded) metals during turnarounds, or during startup or shutdown when the material is below about 500°F (260°C) and the effects of embrittlement are most pronounced.

**4.2.6.8 Related Mechanisms**

Not applicable.

---

#### 4.2.6.9 *References*

1. API RP 581, Risk-Based Inspection Technology, American Petroleum Institute, Washington, D.C., 2008.
2. "High Temperature Corrosion in Refinery and Petrochemical Service," High Temperature Engineering Bulletin HTB-2, INCO, New York, 1960.
3. L. Garverick, "Corrosion in the Petrochemical Industry," ASM International, 1994, pp. 29 and 129 – 136.
4. R. Viswanathan, "Damage Mechanisms and Life Assessment of High Temperature Components," ASM International, 1989.
5. "Metals Handbook – Desk Edition," ASM International, Materials Park, OH.
6. J. Hau and A. Seijas, "Sigma Phase Embrittlement of Stainless Steel in FCC Service", Paper #06578, NACE International, Houston, TX, 2006.
7. API RP 577, "Welding Inspection and Metallurgy", American Petroleum Institute, Washington, D.C.
8. C.N. McCowan et al., "Stainless Steel Weld Metal: Prediction of Ferrite," WRC Bulletin 342, 1989, Welding Research Council, Shaker Heights, OH.
9. E.L. Creamer et al., Embrittlement of Type 347 Stainless Steel Weldments by Sigma Phase", Welding Research Supplement, pages 239-244, June 1969.

**Table 4-1 – Data for Property Trends of Toughness vs. Temperature**

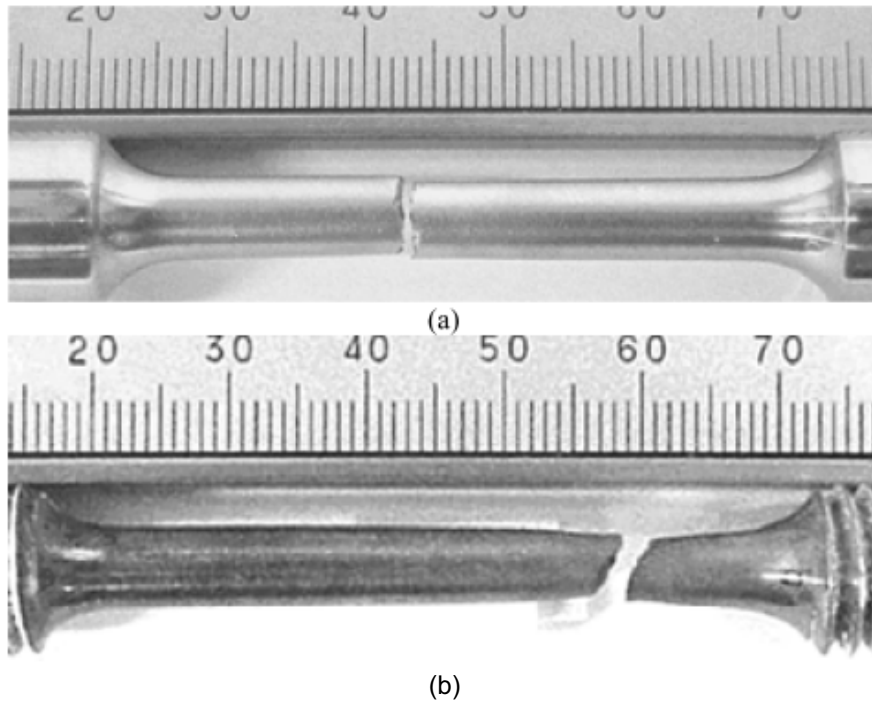
Test Temperature	304 SS 2 % Sigma		321 SS 10% Sigma		304 SS 1% Sigma		304 SS 2% Sigma		347 SS 1 % Sigma	
	% of Impact	% Shear	% of Impact	% Shear	% of Impact	% Shear	% of Impact	% Shear	% of Impact	% Shear
70°F (21°C)	21	0	7	0	–	–	21	10	30	90
500°F (260°C)	38	25	10	20	–	–	–	–	100	100
900°F (480°C)	44	50	15	40	20	10	–	–	100	100
1200°F (650°C)	63	100	21	60	71	90	77	90	100	100

**Notes:**

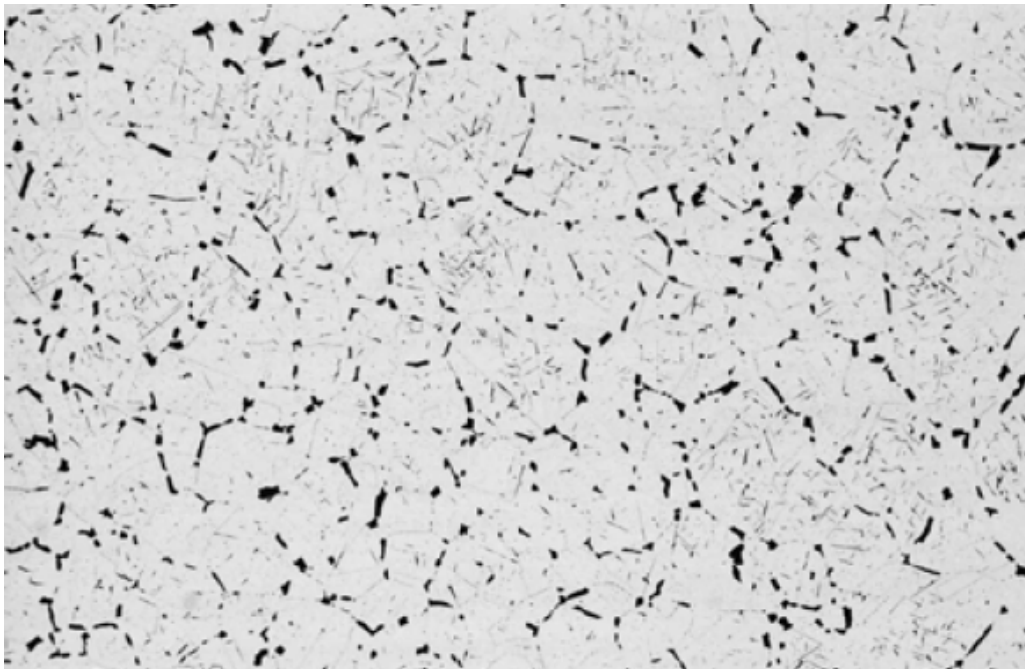
1. Percent of impact is a comparison to original impact strength of non-embrittled materials.
2. The results for 304 SS in columns one and four are for different heats of material under different exposure conditions and are intended to exemplify variability of embrittlement.

**Table 4-2 – Charpy V-notch Impact Test Results, absorbed energy in Joules (ft-lbs) from Reference 6**

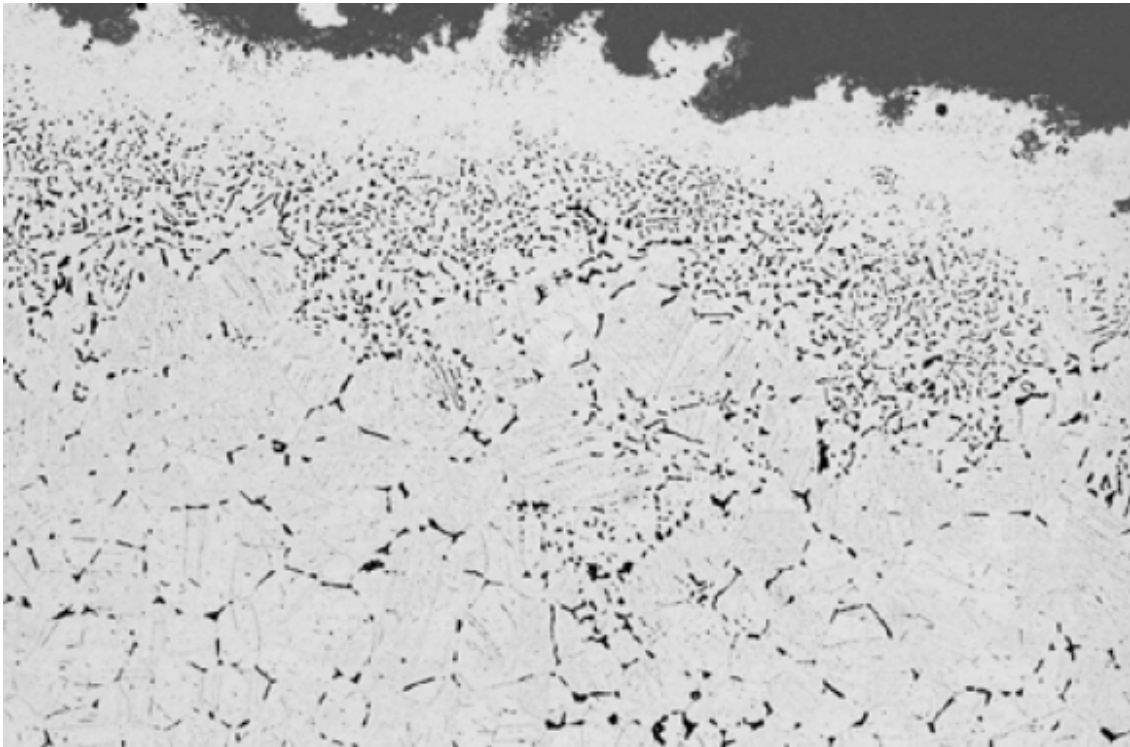
Refinery	Location	Years of Service	Sigma Phase Content (%)	Temperature	
				RT	Service
A	Base Metal	17	4.0	85 (63)	145 (107)
A	Weld Metal	17	8.7	37 (27)	100 (74)
B	Base Metal	19	12.0	12 (9)	43 (32)
C	Base Metal	13	1.5	35 (26)	75 (55)



**Figure 4-7 – Tensile tests from 304H stainless steel FCC flue gas line with 12% sigma phase. The top bar (a) failed in a brittle manner at room temperature. The bottom sample (b) was tested at the operating temperature and shows significant ductility and elongation 1,320°F (716°C), Reference 6.**

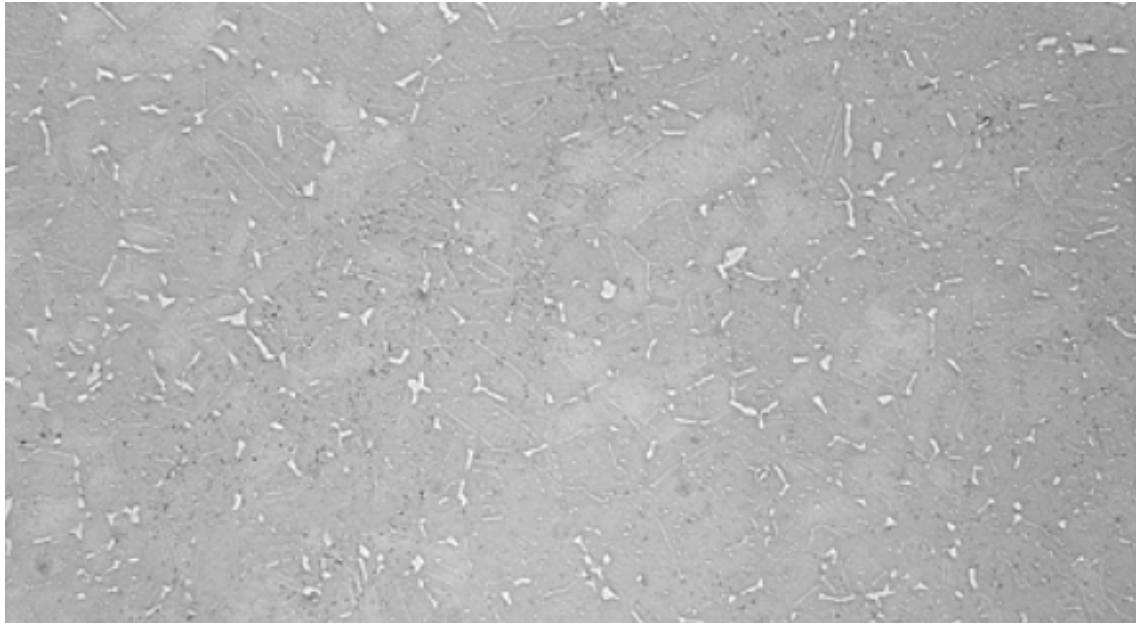


**Figure 4-8 – Microstructure of FCC regenerator plenum chamber wall, electrolytic etch in 33% KOH, 100X. Dark-etching particles are sigma phase, estimated amount 6.0% (Reference 6).**

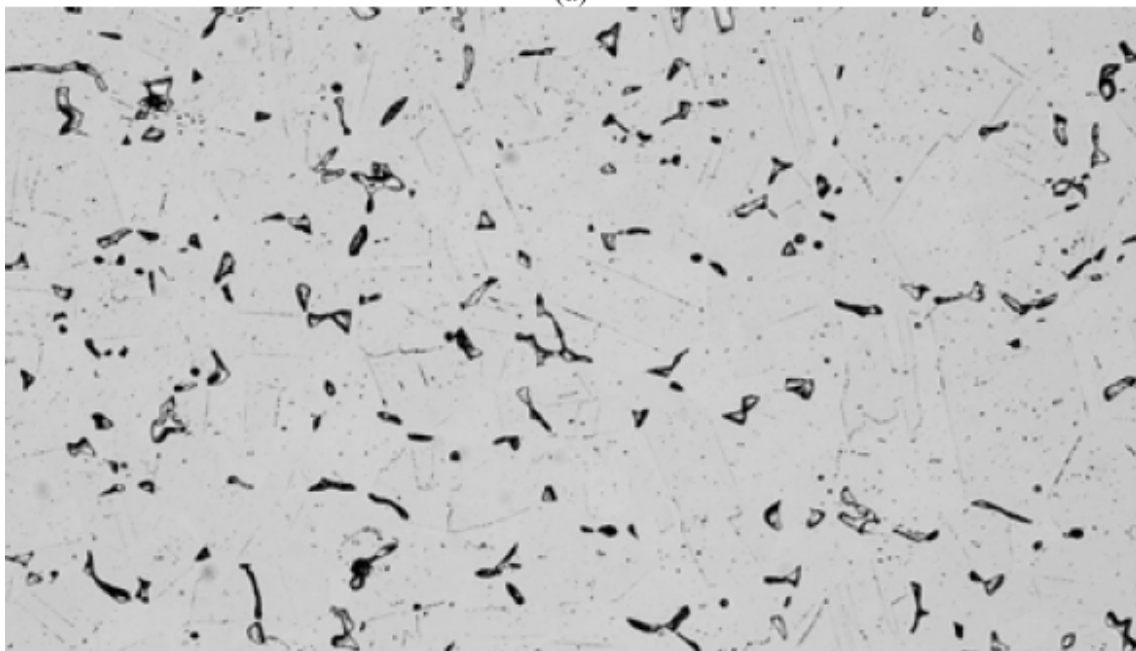


**Figure 4-9 – Dark-etching particles are sigma phase that are concentrated near the outside surface of FCC regenerator plenum chamber, electrolytic etch in 33% KOH, 100X. (Reference. 6).**





(a)



(b)

**Figure 4-10 – Stainless steel 304H with 14 years operation at a nominal temperature of 1,320°F (716°C) after (a) etching in Vilella's reagent, 100X; and (b) electrolytic etching in KOH, 200X. The estimated amount of sigma phase was 5.0%. (Reference 6)**

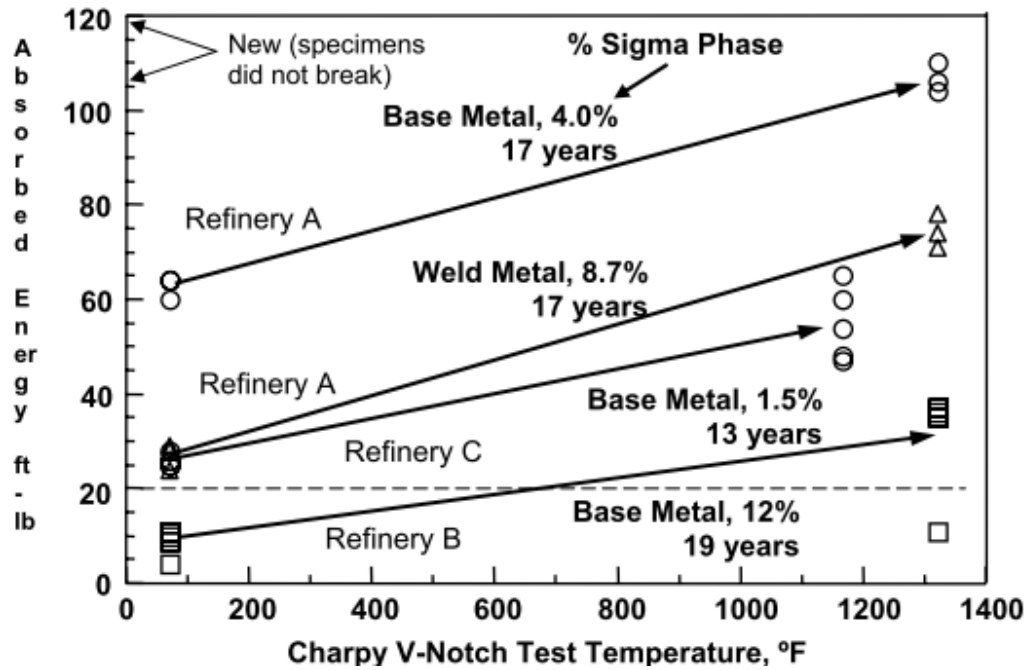


Figure 4-11 – Charpy V-Notch Impact Test Results as absorbed energy in ft-lbf, at room temperature and service temperature (Reference 6).

## **4.2.7 Brittle Fracture**

### **4.2.7.1 Description of Damage**

Brittle fracture is the sudden rapid fracture under stress (residual or applied) where the material exhibits little or no evidence of ductility or plastic deformation.

### **4.2.7.2 Affected Materials**

Carbon steels and low alloy steels are of prime concern, particularly older steels. 400 Series SS are also susceptible.

### **4.2.7.3 Critical Factors**

- a) For a material containing a flaw, brittle fracture can occur. Following are three important factors:
  - 1) The Material fracture toughness (resistance to crack like flaws) as measured in a Charpy impact test;
  - 2) The size, shape and stress concentration effect of a flaw;
  - 3) The amount of residual and applied stresses on the flaw.
- b) Susceptibility to brittle fracture may be increased by the presence of embrittling phases.
- c) Steel cleanliness and grain size have a significant influence on toughness and resistance to brittle fracture.
- d) Thicker material sections also have a lower resistance to brittle fracture due to higher constraint which increases triaxial stresses at the crack tip.
- e) In most cases, brittle fracture occurs only at temperatures below the Charpy impact transition temperature (or ductile-to-brittle transition temperature), the point at which the toughness of the material drops off sharply.

### **4.2.7.4 Affected Units or Equipment**

- a) Equipment manufactured to the ASME Boiler and Pressure Vessel Code, Section VIII, Division 1, prior to the December 1987 Addenda, were made with limited restrictions on notch toughness for vessels operating at cold temperatures. However, this does not mean that all vessels fabricated prior to this date will be subject to brittle fracture. Many designers specified supplemental impact tests on equipment that was intended to be in cold service.
- b) Equipment made to the same code after this date were subject to the requirements of UCS 66 (impact exemption curves).
- c) Most processes run at elevated temperature so the main concern is for brittle fracture during startup, shutdown, or hydrotest/tightness testing. Thick wall equipment on any unit should be considered.
- d) Brittle fracture can also occur during an autorefrigeration event in units processing light hydrocarbons such as methane, ethane/ethylene, propane/propylene, or butane. This includes alkylation units, olefin units and polymer plants (polyethylene and polypropylene). Storage bullets/spheres for light hydrocarbons may also be susceptible.
- e) Brittle fracture can occur during ambient temperature hydrotesting due to high stresses and low toughness at the testing temperature.

**4.2.7.5 Appearance or Morphology of Damage**

- a) Cracks will typically be straight, non-branching, and largely devoid of any associated plastic deformation (although fine shear lips may be found along the free edge of the fracture, or localized necking around the crack (Figure 4-12 to Figure 4-16)).
- b) Microscopically, the fracture surface will be composed largely of cleavage, with limited intergranular cracking and very little microvoid coalescence.

**4.2.7.6 Prevention / Mitigation**

- a) For new equipment, brittle fracture is best prevented by using materials specifically designed for low temperature operation including upset and autorefrigeration events. Materials with controlled chemical composition, special heat treatment and impact test verification may be required. Refer to UCS 66 in Section VIII of the ASME BPV Code.
- b) Brittle fracture is an “event” driven damage mechanism. For existing materials, where the right combination of stress, material toughness and flaw size govern the probability of the event, an engineering study can be performed in accordance with API 579-1/ASME FFS-1, Section 3, Level 1 or 2.
- c) Preventative measures to minimize the potential for brittle fracture in existing equipment are limited to controlling the operating conditions (pressure, temperature), minimizing pressure at ambient temperatures during startup and shutdown, and periodic inspection at high stress locations.
- d) Some reduction in the likelihood of a brittle fracture may be achieved by:
  - 1) Performing a post weld heat treatment (PWHT) on the vessel if it was not originally done during manufacturing; or if the vessel has been weld repaired/modified while in service without the subsequent PWHT.
  - 2) Perform a “warm” pre-stress hydrotest followed by a lower temperature hydrotest to extend the Minimum Safe Operating Temperature (MSOT) envelope.

**4.2.7.7 Inspection and Monitoring**

- a) Inspection is not normally used to mitigate brittle fracture.
- b) Susceptible vessels should be inspected for pre-existing flaws/defects.

**4.2.7.8 Related Mechanisms**

Temper embrittlement (see 4.2.3), strain age embrittlement (see 4.2.4), 885°F (475°C) embrittlement (see 4.2.5), titanium hydriding (see 5.1.3.2) and sigma embrittlement (see 4.2.6).

**4.2.7.9 References**

1. API 579-1/ASME FFS-1 2007 *Fitness-For-Service*, American Petroleum Institute, Washington, D.C., 2007
2. Jeffery A. Smith and Stanley T. Rolfe, “The Effect of Crack Depth (a) and Crack-Depth to Width Ratio (a/W) on the Fracture Toughness of A533-B Steel,” WRC Bulletin 418, Welding Research Council, Shaker Heights, OH.
3. British Standard 7910, Guidance on Methods for Assessing the Acceptability of Flaws in Fusion Welded Structures, British Standards Institution, London, UK.
4. ASME Boiler and Pressure Vessel Code, Section III, Division I, Rules for Construction of Nuclear Power Plant Components ASME, New York, N.Y.



Figure 4-12 – 20-inch carbon steel pipeline that failed during hydrotest at gouges on the O.D.



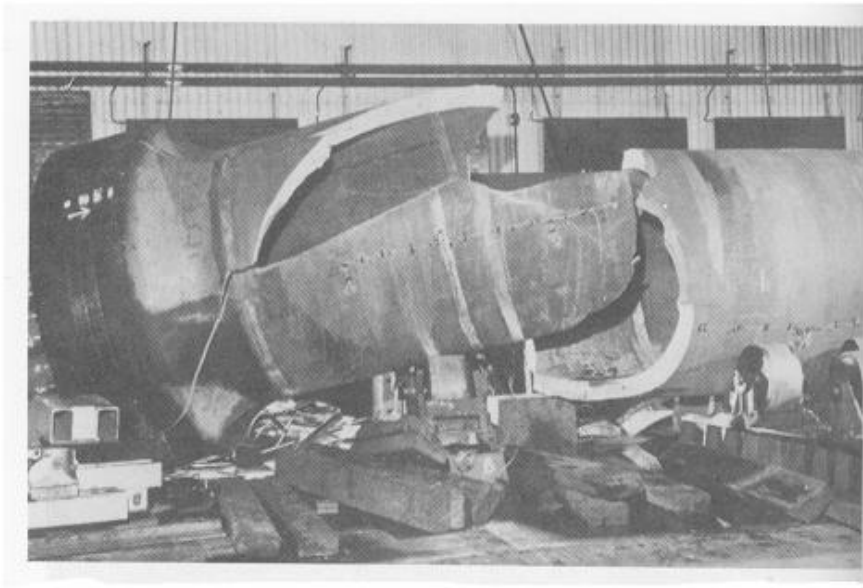
Figure 4-13 – Close-up photograph showing the gouges and the fracture origin (arrow) in one of the gouges.



Figure 4-14 – Brittle Fracture of 2.2 inch wall C-0.5Mo exchanger channel during hydrotest.



Figure 4-15 – Brittle Fracture of vessel shell during hydrotest.



**Figure 4-16 – Classic example of brittle fracture that occurred during hydrotest.**

## 4.2.8 Creep and Stress Rupture

### 4.2.8.1 Description of Damage

- a) At high temperatures, metal components can slowly and continuously deform under load below the yield stress. This time dependent deformation of stressed components is known as creep.
- b) Deformation leads to damage that may eventually lead to a rupture.

### 4.2.8.2 Affected Materials

All metals and alloys.

### 4.2.8.3 Critical Factors

- a) The rate of creep deformation is a function of the material, load, and temperature. The rate of damage (strain rate) is sensitive to both load and temperature. Generally, an increase of about 25°F (12°C) or an increase of 15% on stress can cut the remaining life in half or more, depending on the alloy.
- b) [Table 4-3](#) lists threshold temperatures above which creep damage is a concern. If the metal temperature exceeds these values, then creep damage and creep cracking can occur.
- c) The level of creep damage is a function of the material and the coincident temperature/stress level at which the creep deformation occurs.
- d) The life of metal components becomes nearly infinite at temperatures below the threshold limit ([Table 4-3](#)) even at the high stresses near a crack tip.
- e) The appearance of creep damage with little or no apparent deformation is often mistakenly referred to as creep embrittlement, but usually indicates that the material has low creep ductility.
- f) Low creep ductility is:
  - 1) More severe for higher tensile strength materials and welds.
  - 2) More prevalent at the lower temperatures in the creep range, or low stresses in the upper creep range.
  - 3) More likely in a coarse-grained material than a fine-grained material.
  - 4) Not evidenced by a deterioration of ambient temperature properties.
  - 5) Promoted by certain carbide types in some CrMo steels.
- g) Increased stress due to loss in thickness from corrosion will reduce time to failure.

### 4.2.8.4 Affected Units or Equipment

- a) Creep damage is found in high temperature equipment operating above the creep range. Heater tubes in fired heaters are especially susceptible as well as tube supports, hangers and other furnace internals.
- b) Piping and equipment, such as hot-wall catalytic reforming reactors and furnace tubes, hydrogen reforming furnace tubes, hot wall FCC reactors, FCC main fractionator and regenerator internals all operate in or near the creep range.
- c) Low creep ductility failures have occurred in weld heat-affected zones (HAZ) at nozzles and other high stress areas on catalytic reformer reactors. Cracking has also been found at long seam welds in some high temperature piping and in reactors on catalytic reformers.
- d) Welds joining dissimilar materials (ferritic to austenitic welds) may suffer creep related damage at high temperatures due to differential thermal expansion stresses.



#### 4.2.8.5 *Appearance or Morphology of Damage*

- a) The initial stages of creep damage can only be identified by scanning electron microscope metallography. Creep voids typically show up at the grain boundaries and in later stages form fissures and then cracks.
- b) At temperatures well above the threshold limits, noticeable deformation may be observed. For example, heater tubes may suffer long term creep damage and exhibit significant bulging before final fracture occurs. The amount of deformation is highly dependent on the material, and the combination of temperature and stress level (Figure 4-17 to 4-19).
- c) In vessels and piping, creep cracking can occur where high metal temperatures and stress concentrations occur together, such as near major structural discontinuities including pipe tee joints, nozzles, or welds at flaws. Creep cracking, once initiated, can progress rapidly.

#### 4.2.8.6 *Prevention / Mitigation*

- a) There is little that inspectors or operators can do to prevent this damage once a susceptible material has been placed into creep service, other than to minimize the metal temperature, particularly with fired heater tubes. Avoiding stress concentrators is important during design and fabrication.
- b) Low creep ductility can be minimized by the careful selection of chemistry for low alloy materials. Higher post weld heat treatment temperatures may help minimize creep cracking of materials with low creep ductility such as 1.25Cr-0.5Mo.
- c) Creep damage is not reversible. Once damage or cracking is detected much of the life of the component has been used up and typically the options are to repair or replace the damaged component. Higher PWHT in some cases can produce a more creep ductile material with longer life.
  - 1) Equipment – Repair of creep damaged catalytic reformer reactor nozzles has been successfully accomplished by grinding out the affected area (making sure all the damaged metal is removed), re-welding and careful blend grinding to help minimize stress concentration. PWHT temperatures must be carefully selected and may require a higher PWHT than originally specified.
  - 2) Fired Heater Tubes
    - Alloys with improved creep resistance may be required for longer life.
    - Heaters should be designed and operated to minimize hot spots and localized overheating (Figure 4-19).
    - Visual inspection followed by thickness measurements and or strap readings may be required to assess remaining life of heater tubes in accordance with API 579-1/ASME FFS-1.
    - Minimizing process side fouling/deposits and fire side deposits/scaling can maximize tube life.

#### 4.2.8.7 *Inspection and Monitoring*

- a) Creep damage with the associated microvoid formation, fissuring and dimensional changes is not effectively found by any one inspection technique. A combination of techniques (UT, RT, EC, dimensional measurements and replication) should be employed. Destructive sampling and metallographic examination are used to confirm damage.
- b) For pressure vessels, inspection should focus on welds of CrMo alloys operating in the creep range. The 1 Cr-0.5Mo and 1.25Cr-0.5Mo materials are particularly prone to low creep ductility. Most inspections are performed visually and followed by PT or WFMT on several-year intervals. Angle beam (shear wave) UT can also be employed, although the early stages of creep damage are very difficult to detect. Initial fabrication flaws should be mapped and documented for future reference.

- c) Fired heater tubes should be inspected for evidence of overheating, corrosion, and erosion as follows:
- 1) Tubes should be VT examined for bulging, blistering, cracking, sagging and bowing.
  - 2) Wall thickness measurements of selected heater tubes should be made where wall losses are most likely to occur.
  - 3) Tubes should be examined for evidence of diametric growth (creep) with a strap or go/no go gauge, and in limited cases by metallography on in place replicas or tube samples. However, metallography on the OD of a component may not provide a clear indication of subsurface damage.
  - 4) Retirement criteria based on diametric growth and loss of wall thickness is highly dependent on the tube material and the specific operating conditions.

#### **4.2.8.8      *Related Mechanisms***

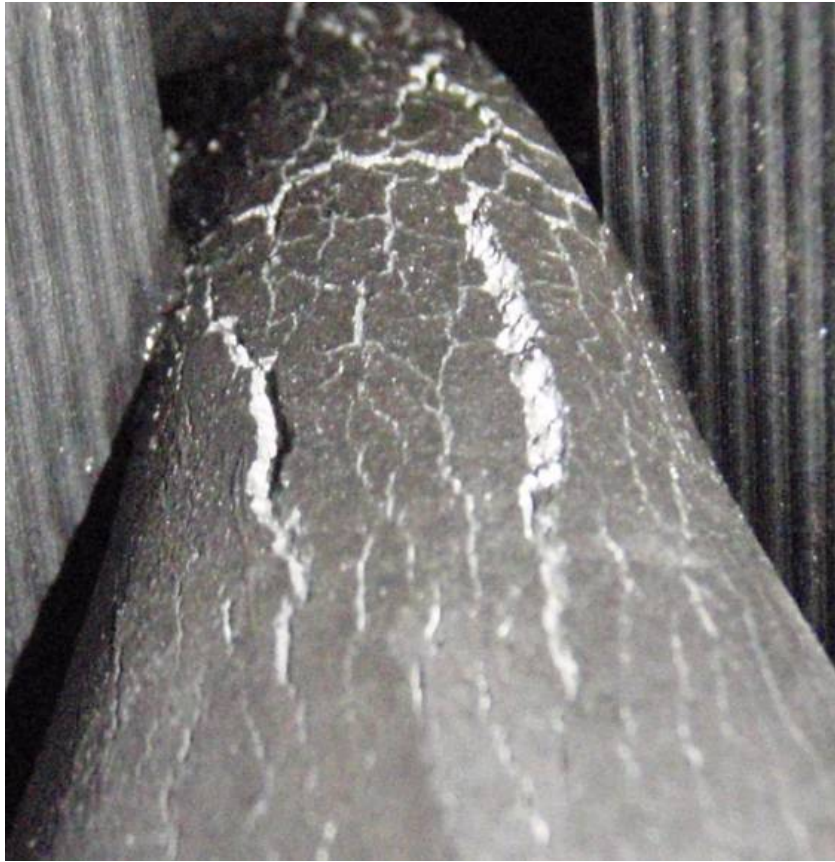
- a) Creep damage that occurs as a result of exposure to very high temperatures is described in [4.2.10](#).
- b) Reheat cracking (see [4.2.19](#)) is a related mechanism found in heavy wall equipment.

#### **4.2.8.9      *References***

1. API 579-1/ASME FFS-1 2007 *Fitness-For-Service*, American Petroleum Institute, Washington, D.C., 2007
2. API Standard 530, Calculation of Heater Tube Thickness in Petroleum Refineries, American Petroleum Institute, Washington, D.C.
3. API Standard 660, Shell and Tube Heat Exchangers for General Refinery Service, American Petroleum Institute, Washington, D.C.

**Table 4-3 – Threshold Temperatures for Creep (Reference 1)**

<b>Material</b>	<b>Temperature Limit</b>
Carbon Steel ( $UTS \leq 414MPa$ (60 ksi))	343°C (650°F)
Carbon Steel ( $UTS > 414MPa$ (60 ksi))	371°C (700°F)
Carbon Steel – Graphitized	371°C (700°F)
C-1/2Mo	399°C (750°F)
1-1/4Cr-1/2Mo – Normalized & Tempered	427°C (800°F)
1-1/4Cr-1/2Mo – Annealed	427°C (800°F)
2-1/4Cr-1Mo – Normalized & Tempered	427°C (800°F)
2-1/4Cr-1Mo – Annealed	427°C (800°F)
2-1/4Cr-1Mo – Quenched & Tempered	427°C (800°F)
2-1/4Cr-1Mo – V	441°C (825°F)
3Cr-1Mo-V	441°C (825°F)
5Cr-1/2Mo	427°C (800°F)
7Cr-1/2Mo	427°C (800°F)
9Cr-1Mo	427°C (800°F)
9Cr-1Mo – V	454°C (850°F)
12 Cr	482°C (900°F)
AISI Type 304 & 304H	510°C (950°F)
AISI Type 316 & 316H	538°C (1000°F)
AISI Type 321	538°C (1000°F)
AISI Type 321H	538°C (1000°F)
AISI Type 347	538°C (1000°F)
AISI Type 347H	538°C (1000°F)
Alloy 800	565°C (1050°F)
Alloy 800H	565°C (1050°F)
Alloy 800HT	565°C (1050°F)
HK-40	649°C (1200°F)



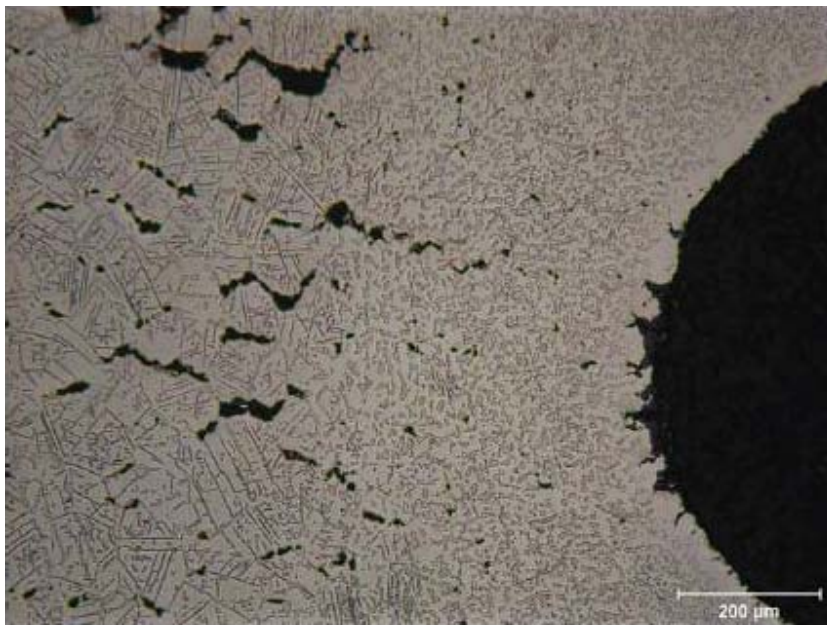
**Figure 4-17 – Pinched Alloy 800H pigtail opened up creep fissures on the surface.**



**Figure 4-18 – Creep rupture of an HK40 heater tube.**



a.)



b.)

**Figure 4-19 – Creep Failure of 310 SS Heater Tube Guide Bolt after approximately 7 years service at 1400°F (760°C). a.) Cross-section at 10X, as-polished. b) Voids and intergranular separation characteristic of long term creep, 100X, etched.**

## 4.2.9 Thermal Fatigue

### 4.2.9.1 Description of Damage

Thermal fatigue is the result of cyclic stresses caused by variations in temperature. Damage is in the form of cracking that may occur anywhere in a metallic component where relative movement or differential expansion is constrained, particularly under repeated thermal cycling.

### 4.2.9.2 Affected Materials

All materials of construction.

### 4.2.9.3 Critical Factors

- a) Key factors affecting thermal fatigue are the magnitude of the temperature swing and the frequency (number of cycles).
- b) Time to failure is a function of the magnitude of the stress and the number of cycles and decreases with increasing stress and increasing cycles.
- c) Startup and shutdown of equipment increase the susceptibility to thermal fatigue. There is no set limit on temperature swings; however, as a practical rule, cracking may be suspected if the temperature swings exceeds about 200°F (93°C).
- d) Damage is also promoted by rapid changes in surface temperature that result in a thermal gradient through the thickness or along the length of a component. For example: cold water on a hot tube (thermal shock); rigid attachments and a smaller temperature differential; inflexibility to accommodate differential expansion.
- e) Notches (such as the toe of a weld) and sharp corners (such as the intersection of a nozzle with a vessel shell) and other stress concentrations may serve as initiation sites.

### 4.2.9.4 Affected Units or Equipment

- a) Examples include the mix points of hot and cold streams such as hydrogen mix points in hydroprocessing units, and locations where condensate comes in contact with steam systems, such as de-superheating or attemperating equipment (Figures 4-20 and 4-23).
- b) Thermal fatigue cracking has been a major problem in coke drum shells. Thermal fatigue can also occur on coke drum skirts where stresses are promoted by a variation in temperature between the drum and skirt (Figure 4-21 and Figure 4-22).
- c) In steam generating equipment, the most common locations are at rigid attachments between neighboring tubes in the superheater and reheater. Slip spacers designed to accommodate relative movement may become frozen and act as a rigid attachment when plugged with fly ash.
- d) Tubes in the high temperature superheater or reheater that penetrate through the cooler waterwall tubes may crack at the header connection if the tube is not sufficiently flexible. These cracks are most common at the end where the expansion of the header relative to the waterwall will be greatest.
- e) Steam actuated soot blowers may cause thermal fatigue damage if the first steam exiting the soot blower nozzle contains condensate. Rapid cooling of the tube by the liquid water will promote this form of damage. Similarly, water lancing or water cannon use on waterwall tubes may have the same effect.

#### **4.2.9.5      *Appearance or Morphology of Damage***

- a) Thermal fatigue cracks usually initiate on the surface of the component. They are generally wide and often filled with oxides due to elevated temperature exposure. Cracks may occur as single or multiple cracks.
- b) Thermal fatigue cracks propagate transverse to the stress and they are usually dagger-shaped, transgranular, and oxide filled (Figure 4-24 and 4-25). However, cracking may be axial or circumferential, or both, at the same location.
- c) In steam generating equipment, cracks usually follow the toe of the fillet weld, as the change in section thickness creates a stress raiser. Cracks often start at the end of an attachment lug and if there is a bending moment as a result of the constraint, they will develop into circumferential cracks into the tube.
- d) Water in soot blowers may lead to a crazing pattern. The predominant cracks will be circumferential and the minor cracks will be axial. (Figure 4-26 to 4-27).

#### **4.2.9.6      *Prevention / Mitigation***

- a) Thermal fatigue is best prevented through design and operation to minimize thermal stresses and thermal cycling. Several methods of prevention apply depending on the application.
  - 1) Designs that incorporate reduction of stress concentrators, blend grinding of weld profiles, and smooth transitions should be used.
  - 2) Controlled rates of heating and cooling during startup and shutdown of equipment can lower stresses.
  - 3) Differential thermal expansion between adjoining components of dissimilar materials should be considered.
- b) Designs should incorporate sufficient flexibility to accommodate differential expansion.
  - 1) In steam generating equipment, slip spacers should slip and rigid attachments should be avoided.
  - 2) Drain lines should be provided on soot-blowers to prevent condensate in the first portion of the soot blowing cycle.
- c) In some cases, a liner or sleeve may be installed to prevent a colder liquid from contacting the hotter pressure boundary wall

#### **4.2.9.7      *Inspection and Monitoring***

- a) Since cracking is usually surface connected, visual examination, MT and PT are effective methods of inspection.
- b) External SWUT inspection can be used for non-intrusive inspection for internal cracking and where reinforcing pads prevent nozzle examination.
- c) Heavy wall reactor internal attachment welds can be inspected using specialized ultrasonic techniques.

#### **4.2.9.8      *Related Mechanisms***

Corrosion fatigue (see 4.5.2) and dissimilar metal weld cracking (see 4.2.12).



**4.2.9.9     References**

1. "Steam - Its Generation and Use," 40th Edition, Babcock & Wilcox, 1992.
2. "Combustion Fossil Power Systems," Third Edition, Combustion Engineering, CT, 1981.
3. H. Thielsch, "Defects And Failures In Pressure Vessels and Piping," Krieger Publishing Co., NY, 1977.
4. R.D. Port and H.M. Herro, "The NALCO Guide To Boiler Failure Analysis," McGraw Hill, NY, 1991.
5. D.N. French, "Metallurgical Failures In Fossil Fired Boilers," John Wiley & Sons, Publishers, Inc., NY, 1993.
6. B. Dooley and W. McNaughton, "Boiler Tube Failures: Theory and Practice – 3 Volumes," EPRI, CA, 1995.



Figure 4-20 – Thermal fatigue cracks on the inside of a heavy wall SS pipe downstream of a cooler  $H_2$  injection into a hot hydrocarbon line.

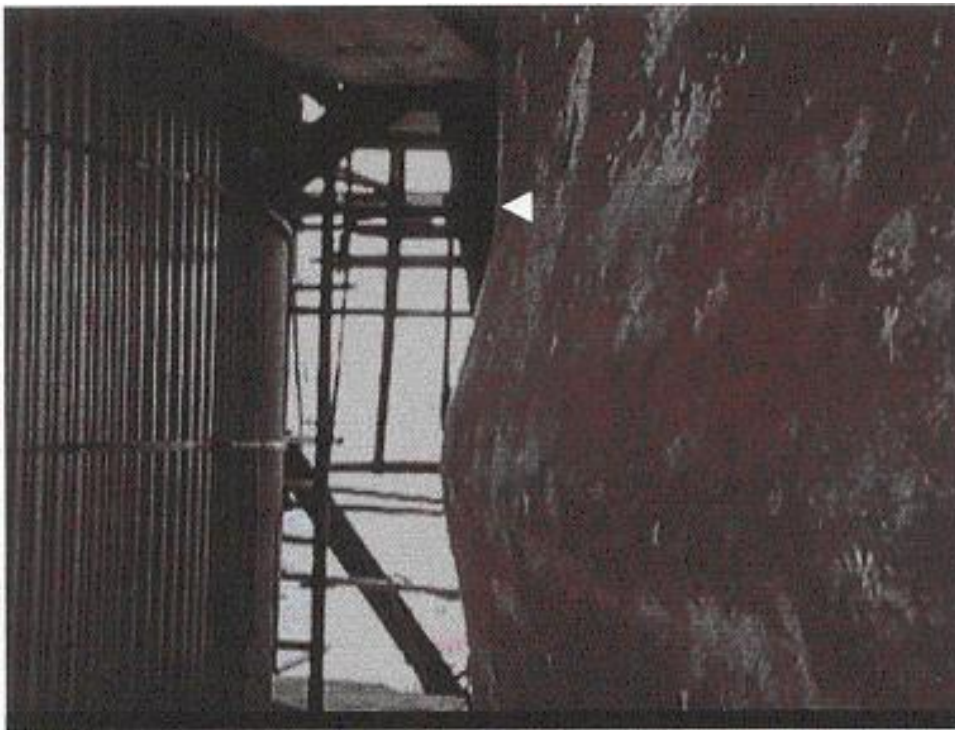


Figure 4-21 – Bulging in a skirt of a coke drum.



Figure 4-22 –Thermal fatigue cracking associated with bulged skirt shown in Figure 4-21.

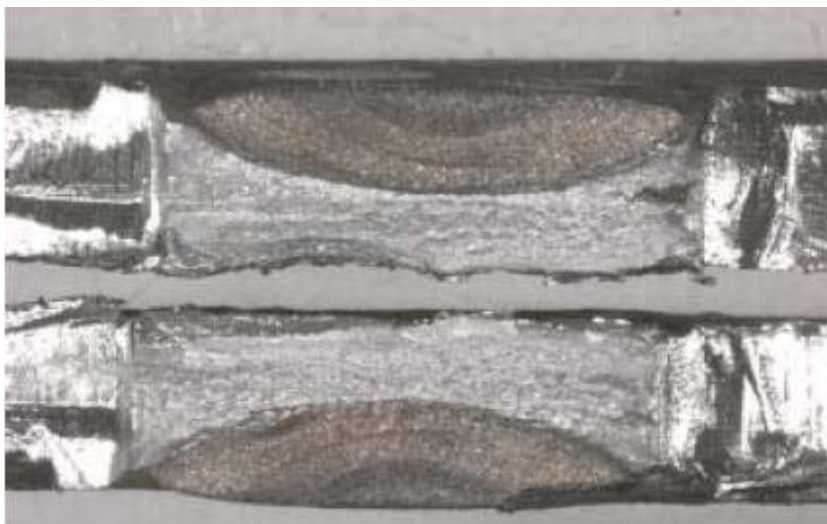


Figure 4-23 – Thermal fatigue of 304L stainless at mix point in the BFW preheater bypass line around the high temperature shift effluent exchanger in a hydrogen reformer. The delta T is 325°F (181°C) at an 8 inch bypass line tying into a 14 inch line, 3 yrs after startup.

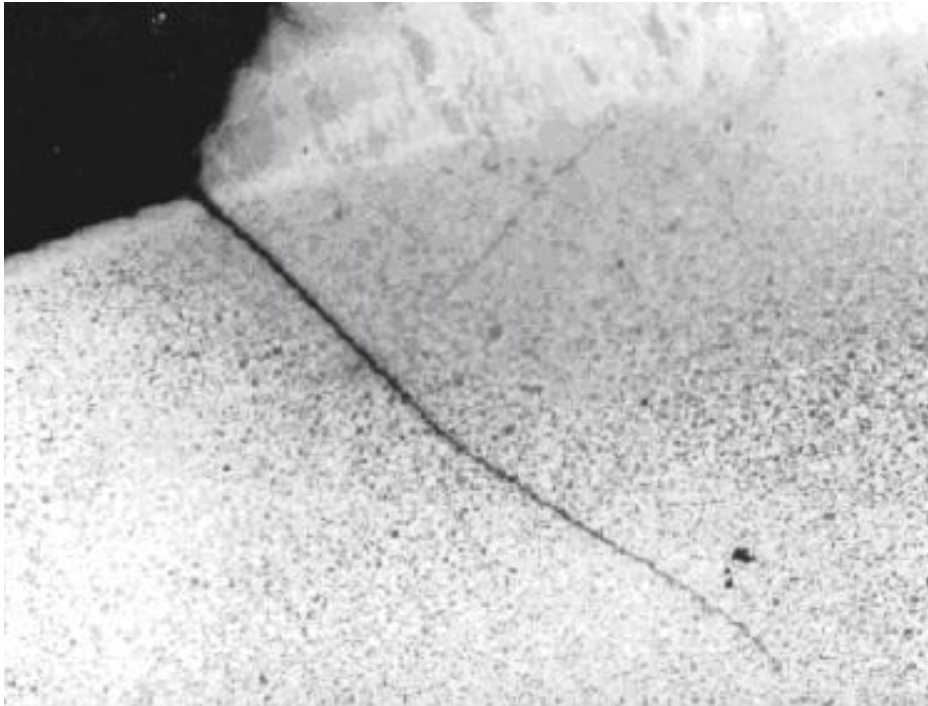


Figure 4-24 – In a carbon steel sample, metallographic section through a thermal fatigue crack indicates origin at the toe of an attachment weld. Mag. 50X, etched.

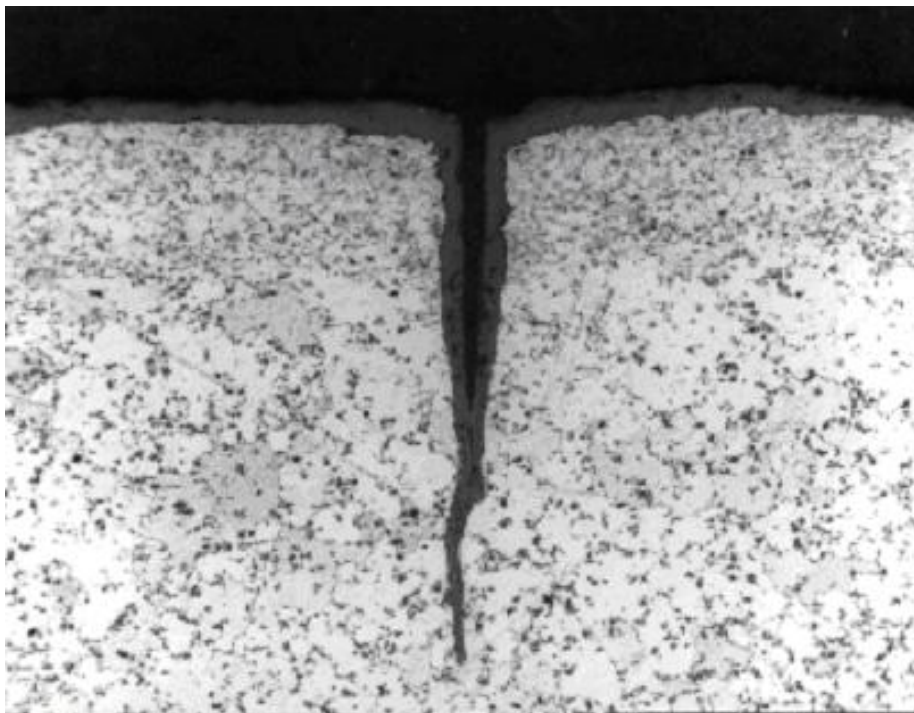
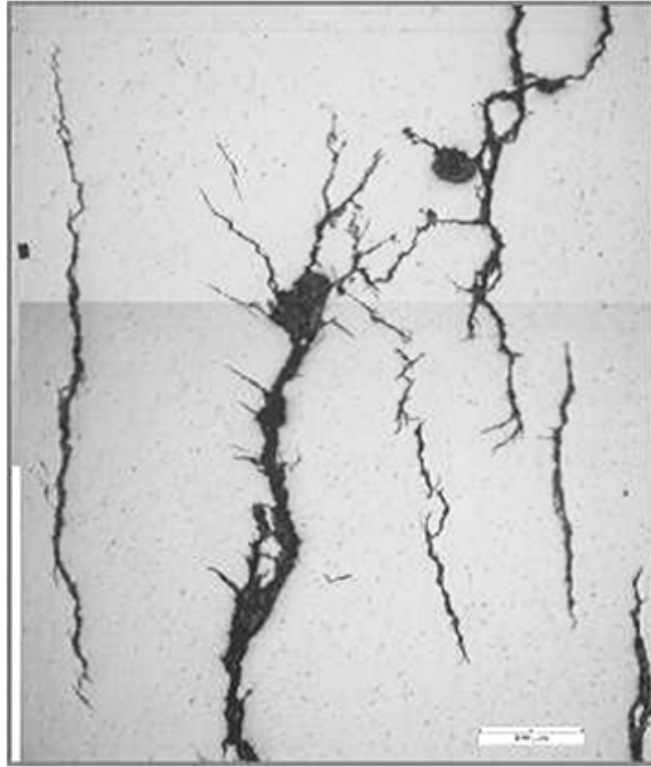
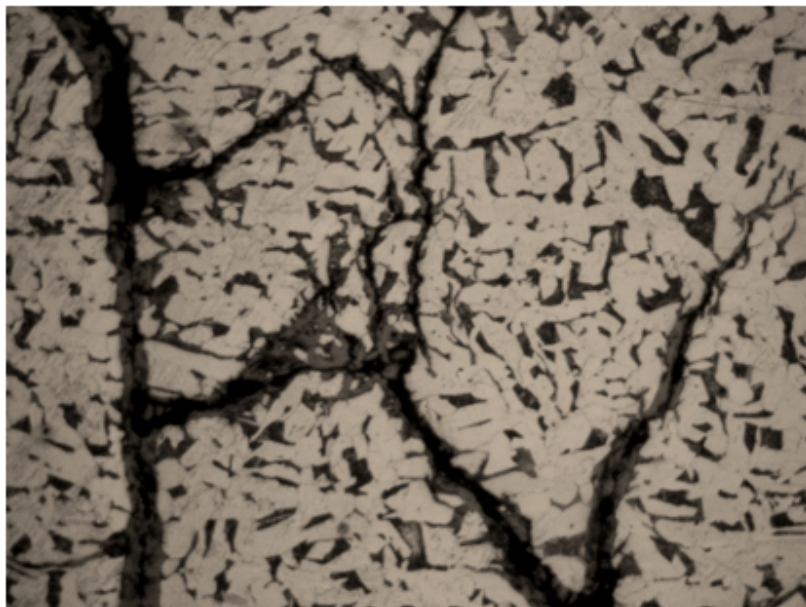


Figure 4-25 – Older cracks fill with oxide, may stop and restart (note jog part way along the crack), and do not necessarily require a change in section thickness to initiate the crack. Mag. 100X, etched.



**Figure 4-26 – Metallographic cross-section of a superheated steam outlet that failed from thermal fatigue. Unetched.**



**Figure 4-27 – Photomicrograph of the failed superheated steam outlet shown in Figure 4-26. Etched.**

## **4.2.10 Short Term Overheating – Stress Rupture**

### **4.2.10.1 Description of Damage**

Permanent deformation occurring at relatively low stress levels as a result of localized overheating. This usually results in bulging and eventually failure by stress rupture.

### **4.2.10.2 Affected Materials**

All fired heater tube materials and common materials of construction.

### **4.2.10.3 Critical Factors**

- a) Temperature, time and stress are critical factors.
- b) Usually due to flame impingement or local overheating.
- c) Time to failure will increase as internal pressures or loading decrease. However, bulging and distortion can be significant at low stresses, as temperatures increase.
- d) Local overheating above the design temperature.
- e) Loss in thickness due to corrosion will reduce time to failure by increasing the stress.

### **4.2.10.4 Affected Units or Equipment**

- a) All boiler and fired heater tubes are susceptible.
- b) Furnaces with coking tendencies such as crude, vacuum, heavy oil hydroprocessing and coker units are often fired harder to maintain heater outlet temperatures and are more susceptible to localized overheating.
- c) Hydroprocessing reactors may be susceptible to localized overheating of reactor beds due to inadequate hydrogen quench or flow maldistribution.
- d) Refractory lined equipment in the FCC, sulfur plant and other units may suffer localized overheating due to refractory damage and/or excessive firing.

### **4.2.10.5 Appearance or Morphology of Damage**

- a) Damage is typically characterized by localized deformation or bulging on the order of 3% to 10% or more, depending on the alloy, temperature and stress level.
- b) Ruptures are characterized by open “fishmouth” failures and are usually accompanied by thinning at the fracture surface ([Figure 4-28 to 4-31](#)).

### **4.2.10.6 Prevention / Mitigation**

- a) Minimize localized temperature excursions.
- b) Fired heaters require proper burner management and fouling/deposit control to minimize hot spots and localized overheating.
- c) Utilize burners which produce a more diffuse flame pattern.
- d) In hydroprocessing equipment, install and maintain bed thermocouples in reactors and minimize the likelihood of hot spots through proper design and operation.
- e) Maintain refractory in serviceable condition in refractory lined equipment.

**4.2.10.7 Inspection and Monitoring**

- a) In fired heaters, visual observation, IR monitoring of tubes and tubeskin thermocouples are used to monitor temperatures.
- b) Refractory lined equipment can be monitored with heat indicating paint and periodic IR scans. Inspect for refractory damage during shutdowns.
- c) Maintain and monitor reactor bed thermocouples as well as reactor skin thermocouples.

**4.2.10.8 Related Mechanisms**

Creep/stress rupture (see [4.2.8](#)).

**4.2.10.9 References**

1. API 579-1/ASME FFS-1 2007 *Fitness-For-Service*, American Petroleum Institute, Washington, D.C., 2007
2. API Standard 530, Calculation of Heater Tube Thickness in Petroleum Refineries, American Petroleum Institute, Washington, D.C.
3. API Standard 660, Shell and Tube Heat Exchangers for General Refinery Service, American Petroleum Institute, Washington, D.C.



**Figure 4-28 – Short term overheating failure of a vertical 4.5-in. OD, Schedule 160 2.25Cr-1Mo (SA335-P2) hydrocracker radiant that was 21 years old. Failure occurred due process side starvation with burners running.**

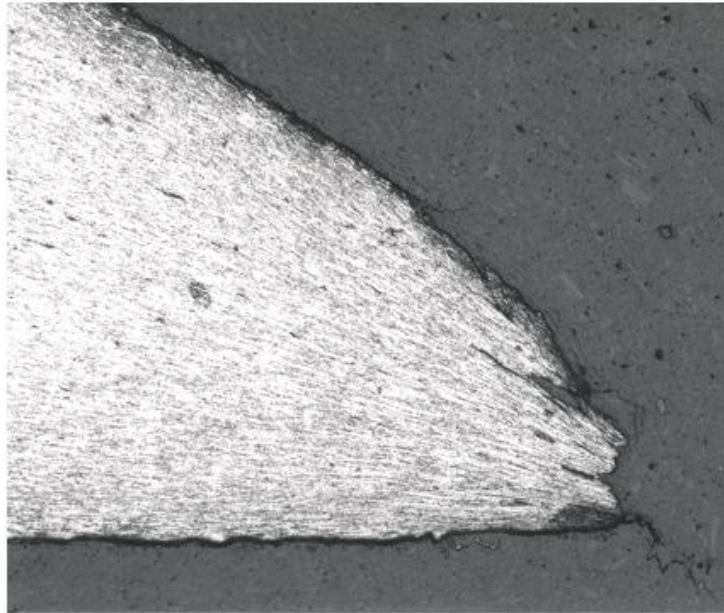




**Figure 4-29 – Short term overheating tube failed by bulging and rupture due to short term overheating at a temperature well over 1380°F (750°C).**



**Figure 4-30 – 1Cr-0.5Mo boiler superheater tube in 700 psig steam service that failed due to overheating.**



**Figure 4-31 – The fracture-edge microstructure displays severely elongated ferrite grains, proof of the ductility of the rupture. The thickness at the edge here is about 0.01 inch for a reduction in the wall thickness of more than 95%. 50X, etched.**

## 4.2.11 Steam Blanketing

### 4.2.11.1 Description of Damage

The operation of steam generating equipment is a balance between the heat flow from the combustion of the fuel and the generation of steam within the waterwall or generating tube. The flow of heat energy through the wall of the tube results in the formation of discrete steam bubbles (nucleate boiling) on the ID surface. The moving fluid sweeps the bubbles away. When the heat flow balance is disturbed, individual bubbles join to form a steam blanket, a condition known as Departure From Nucleate Boiling (DNB). Once a steam blanket forms, tube rupture can occur rapidly, as a result of short term overheating, usually within a few minutes.

### 4.2.11.2 Affected Materials

Carbon steel and low alloy steels.

### 4.2.11.3 Critical Factors

- a) Heat flux and fluid flow are critical factors.
- b) Flame impingement from misdirected or damaged burners can provide a heat flux greater than the steam generating tube can accommodate.
- c) On the water side, anything that restricts fluid flow (for example, pinhole leaks lower in the steam circuit or dented tubes from slag falls) will reduce fluid flow and can lead to DNB conditions.
- d) Failure occurs as a result of the hoop stress in the tube from the internal steam pressure at the elevated temperature.

### 4.2.11.4 Affected Units or Equipment

All steam-generating units including fired boilers, waste heat exchangers in sulfur plants, hydrogen reformers and FCC units. Failures can occur in superheaters and reheaters during start-up when condensate blocks steam flow.

### 4.2.11.5 Appearance or Morphology of Damage

- a) These short-term, high-temperature failures always show an open burst with the fracture edges drawn to a near knife-edge ([Figure 4-32](#)).
- b) The microstructure will always show severe elongation of the grain structure due to the plastic deformation that occurs at the time of failure.

### 4.2.11.6 Prevention / Mitigation

- a) When a DNB condition has developed, tube rupture will quickly follow. Proper burner management should be practiced to minimize flame impingement.
- b) Proper BFW treatment can help prevent some conditions that can lead to restricted fluid flow.
- c) Tubes should be visually inspected for bulging.

### 4.2.11.7 Inspection and Monitoring

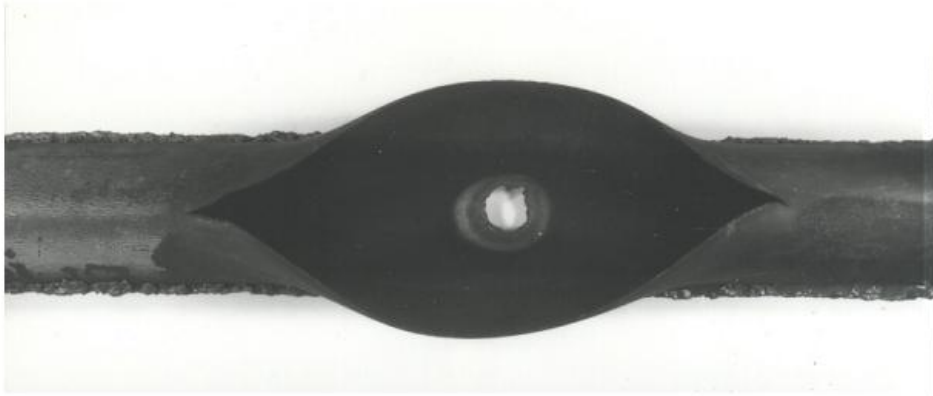
Burners should be properly maintained to prevent flame impingement.

### 4.2.11.8 Related Mechanisms

- a) Steam blanketing can cause caustic corrosion (caustic gouging) as outlined in [4.3.10](#).
- b) Very similar characteristics are observed in short term overheating (see [4.2.10](#)).

**4.2.11.9 References**

1. "Steam - Its Generation and Use," 40th Edition, Babcock & Wilcox, 1992.
2. "Combustion Fossil Power Systems," Third Edition, Combustion Engineering, CT, 1981.
3. H. Thielsch, "Defects And Failures In Pressure Vessels and Piping," Krieger Publishing Co., NY, 1977.
4. R.D. Port and H.M. Herro, "The NALCO Guide To Boiler Failure Analysis," McGraw Hill, NY, 1991.
5. D.N. French, "Metallurgical Failures In Fossil Fired Boilers," John Wiley & Sons, Inc., NY, 1993.
6. B. Dooley and W. McNaughton, "Boiler Tube Failures: Theory and Practice – 3 Volumes," EPRI, CA, 1995.



**Figure 4-32 – Short-term high-temperature failures from DNB are wide-open bursts with the failure lips drawn to a near knife edge. They are ductile ruptures. Mag. 25X.**

## 4.2.12 Dissimilar Metal Weld (DMW) Cracking

### 4.2.12.1 Description of Damage

Cracking of dissimilar metal welds occurs in the ferritic (carbon steel or low alloy steel) side of a weld between an austenitic (300 Series SS or Nickel base alloy) and a ferritic material operating at high temperature (Figure 4-33 and 4-44). Cracking can result from creep damage, from fatigue cracking, from sulfide stress cracking or hydrogen disbonding.

### 4.2.12.2 Affected Materials

The most common are ferritic materials such as carbon steel and low alloy steels that are welded to the austenitic stainless steels as well as any material combinations that have widely differing thermal expansion coefficients.

### 4.2.12.3 Critical Factors

- a) Important factors include the type of filler metal used to join the materials, heating and cooling rate, metal temperature, time at temperature, weld geometry and thermal cycling.
- b) Cracking can occur because of the different coefficients of thermal expansion between ferritic and austenitic (e.g. 300 Series stainless steel or nickel-base alloys) which differ by about 25 to 30% or more. At high operating temperatures, the differences in thermal expansion leads to high stress at the heat-affected zone on the ferritic side (Table 4-4).
- c) As the operating temperature increases, differential thermal expansion between the metals results in increasing stress at the weldment, particularly if a 300 Series SS weld metal is used. Ferritic/austenitic joints can generate significant thermal expansion/thermal fatigue stresses at temperatures greater than 510°F (260°C).
- d) Thermal cycling aggravates the problem. Stresses during start up and shut down can be significant.
- e) Stresses acting on the weldment are significantly higher when an austenitic stainless steel filler metal is used. A nickel base filler metal has a coefficient of thermal expansion that is closer to carbon steel, resulting in significantly lower stress at elevated temperatures.
- f) For dissimilar welds that operate at elevated temperatures, the problem is aggravated by the diffusion of carbon out of the heat-affected zone of the ferritic material and into the weld metal. The loss of carbon reduces the creep strength of the ferritic material heat-affected zone, thereby increasing the cracking probability (Figure 4-35). The temperature at which carbon diffusion becomes a concern is above 800°F to 950°F (427°C to 510°C) for carbon steels and low alloy steels, respectively.
- g) Dissimilar metal welds on a ferritic steel that are made with a 300 Series SS weld metal or a nickel-based filler metal result in a narrow region (mixed zone) of high hardness at the toe of the weld, near the fusion line on the ferritic steel side. These high hardness zones render the material susceptible to various forms of environmental cracking such as sulfide stress cracking or hydrogen stress cracking (Figures 4-36 and 4-37). PWHT of the weldment will not prevent environmental cracking if the weld is exposed to wet H<sub>2</sub>S conditions.
- h) DMW's for high temperature service in hydrogen environments must be carefully designed and inspected to prevent hydrogen disbonding (Figures 4-38 to 4-41).
- i) In environments that promote liquid ash corrosion, weld cracking problems may be accelerated by stress-assisted corrosion. The ferritic heat-affected zone will preferentially corrode due to the large thermal strain. The results are long, narrow, oxide wedges that parallel the fusion line of the weld (Figure 4-42).
- j) Poor geometry of the weld, excessive undercut, and other stress intensification factors will promote crack formation.

#### 4.2.12.4 *Affected Units or Equipment*

- a) Dissimilar metal welds are utilized in special applications in refineries and other process plants.
- b) Examples of DMW's include:
  - Welds used to join clad pipe in locations such as transitions in hydroprocessing reactor outlet piping from overlaid low alloy CrMo nozzles or piping to solid 300 Series stainless steel pipe.
  - Hydroprocessing exchanger inlet and outlet piping.
  - Alloy transitions inside fired heaters (e.g. 9Cr to 317L in a crude furnace)
  - Hydrogen reformer furnace 1.25 Cr inlet pigtailed to Alloy 800 socketlets or weldoletts on Hydrogen reformer tubes
  - Hydrogen reformer furnace Alloy 800 outlet cones to CS or 1.25 Cr refractory lined transfer lines.
  - Alloy transitions inside fired heaters (e.g. 9Cr to 317L in a crude or vacuum furnace)
  - Welds joining clad pipe sections to themselves or to unclad carbon or low alloy steel pipe (e.g. Alloy C276 clad CS piping in crude unit overhead system)
  - Nickel base alloy welds joining socket weld valves in 5 and 9 Cr piping systems
  - 300 series SS weld overlay in numerous refinery reactors and pressure vessels
  - Similar DMWs have been used in FCCU reactors and regenerator vessels and in Coker Units.
- c) All superheaters and reheaters that have welds between ferritic materials (1.25Cr-0.5Mo and 2.25Cr-1Mo) and the austenitic materials (300 Series SS, 304H, 321H and 347H).

#### 4.2.12.5 *Appearance or Morphology of Damage*

- a) In most cases, the cracks form at the toe of the weld in the heat-affected zone of the ferritic material ([Figure 4-36](#) to [Figure 4-42](#)).
- b) Welds joining tubes are the most common problem area, but support lugs or attachments of cast or wrought 300 Series SS to 400 Series SS are also affected.

#### 4.2.12.6 *Prevention / Mitigation*

- a) For high temperature applications, nickel base filler metals which have a coefficient of thermal expansion closer to carbon steel and low alloy steels may dramatically increase the life of the joint, because of the significant reduction in thermal stress acting on the steel (ferritic) side of the joint. Refer to API 577 and API 582 for additional information on filler metal selection, welding procedures and weld inspection.
- b) If 300 Series SS welding electrodes are used, the dissimilar metal weld should be located in a low temperature region.
- c) Consider buttering the ferritic side of the joint with the SS or nickel base filler metal and perform PWHT prior to completing the DMW to minimize the hardness of the mixed weld zone in order to minimize susceptibility to environmental cracking. See [Figure 4-34](#) and [4-35](#).
- d) On buttered joints, the thickness of the weld metal should be a minimum of 0.25 inch (6.35 mm) after the bevel is machined. [Figure 4-35](#).
- e) In steam generating equipment, the weld at the high temperature end should be made in the penthouse or header enclosure, out of the heat transfer zone.

- f) For high temperature installations, consider installing a pup piece that has an intermediate thermal expansion coefficient between the two materials to be joined.

#### 4.2.12.7 *Inspection and Monitoring*

- a) The following elements should be considered for non-destructive examination of critical dissimilar butt welds before they are put into service:
- 100% PT after buttering and completion
  - 100% UT on butter layer after PWHT (check bonding)
  - 100% RT
  - 100% UT – recordable
  - PMI
- b) For dissimilar welds in fired heater tubes, RT and UT shear wave inspection should be performed.
- c) Environmental cracking will also result in surface breaking cracks initiating on the ID surface exposed to the corrosive environment, which can be detected using WFMT or external SWUT methods.

#### 4.2.12.8 *Related Mechanisms*

Thermal fatigue (see 4.2.9), corrosion fatigue (see 4.5.2), creep (see 4.2.8), and sulfide stress cracking (see 5.1.2.3.)

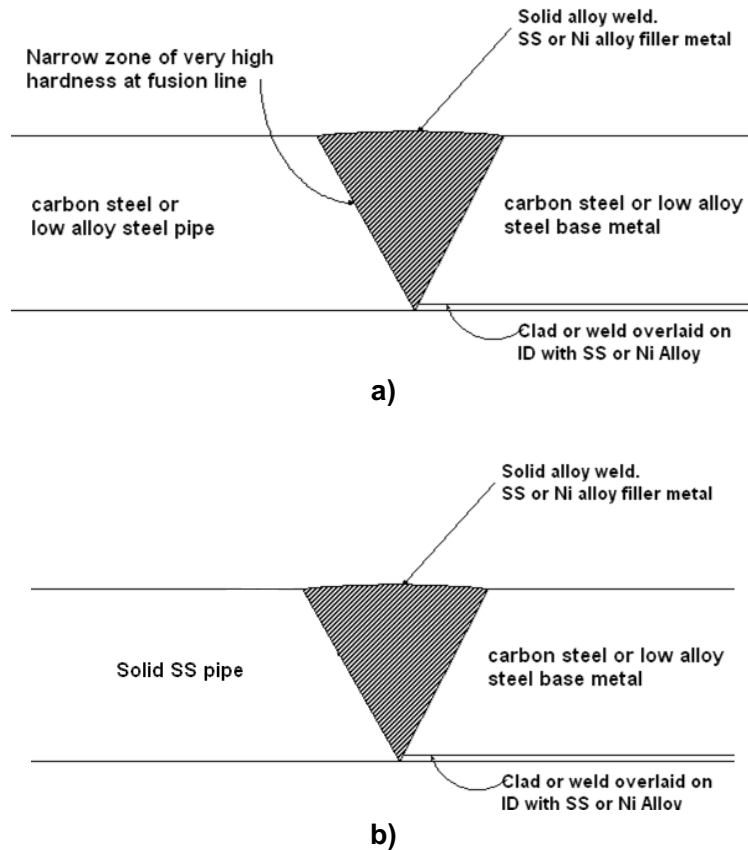
#### 4.2.12.9 *References*

1. "Steam - Its Generation and Use," 40th Edition, Babcock & Wilcox, 1992.
2. "Combustion Fossil Power Systems," Third Edition, *Combustion Engineering*, CT, 1981.
3. H. Thielsch, "Defects and Failures In Pressure Vessels and Piping," Krieger Co., NY, 1977.
4. R.D. Port and H.M. Herro, "The NALCO Guide to Boiler Failure Analysis," McGraw-Hill, NY, 1991.
5. D.N. French, "Metallurgical Failures in Fossil Fired Boilers," John Wiley & Sons, Inc., NY, 1993.
6. B. Dooley and W. McNaughton, "Boiler Tube Failures: Theory and Practice – 3 Volumes," EPRI, CA, 1995.
7. R.H. Ryder and C.F. Dahms, "Design Criteria for Dissimilar Metal Welds," *WRC Bulletin No.350*, Welding Research Council, Shaker Heights, OH, January 1990.
8. L. E. Penuela et al., "Analysis of dissimilar welds exposed to high temperature H<sub>2</sub>/H<sub>2</sub>S conditions in a hydrodesulfurizing (HDS) unit, NACE International, Paper #99383, Houston, TX, 1999.
9. K.R. Lewis et al., "Assessment of operating limits for critical dissimilar metal welds in a hydrocracker", NACE International, Paper #01532, Houston, TX, 2002.
10. API 579-1/ASME FFS-1 2007 *Fitness-For-Service*, American Petroleum Institute, Washington, D.C., 2007.
11. API RP 577, "Welding Inspection and Metallurgy", American Petroleum Institute, Washington, D.C.
12. API Subcommittee on Corrosion and Materials, Roundtable on Dissimilar Welds April 17, 2007, Seattle, WA.
13. API RP 582, "Welding Guidelines for the Chemical, Oil, and Gas Industries", American Petroleum Institute, Washington, D.C.

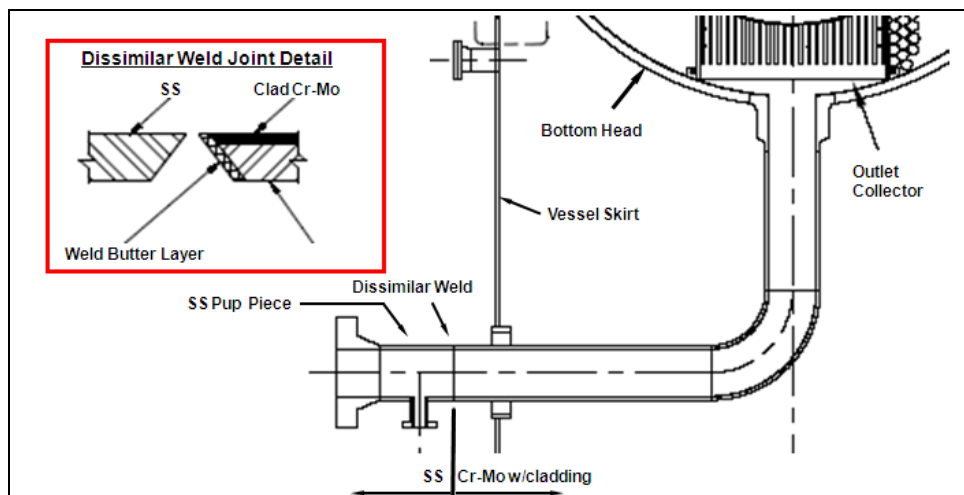


**Table 4-4: Coefficients of Thermal Expansion for Common Materials**

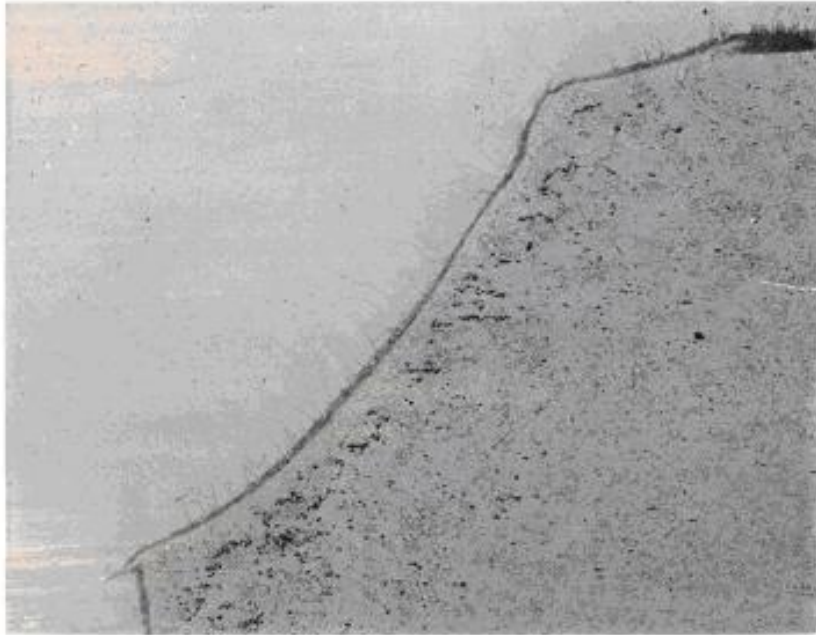
<b>Material</b>	<b>Coefficient (in/in/F x 10<sup>-6</sup>) to 800°F (427°C)</b>
CS	7.97
1 Cr-1/2 Mo	7.53
2 ¼ Cr-1 Mo	7.53
300 Series SS	10.05
Alloy 600	8



**Figure 4-33 – Two primary DMW configurations.**  
 a ) Ferritic steel pipe (left) welded to clad or weld overlaid pipe (right)  
 b) Solid Stainless steel pipe (left) welded to clad or weld overlaid pipe (right)



**Figure 4-34 – Schematic of typical weld detail used to join a solid stainless steel pipe to a clad or weld overlaid pipe. The sequence is: 1) Butter the weld bevel on the ferritic steel side, 2) Perform PWHT of the ferritic side prior to making dissimilar weld, 3) Complete the dissimilar weld using alloy filler metal, 4) Do not PWHT the completed dissimilar weld.**



**Figure 4-35 – High magnification photomicrograph of a DMW joining a ferritic alloy (SA213 T-22) used in high temperature service. Creep cracks (black specks) can be observed in the ferritic alloy heat-affected zones. Mag. 50X, etched.**



**Figure 4-36 – Weld detail used to join a carbon steel elbow (bottom) to a weld overlaid pipe section (top) in high pressure wet H<sub>2</sub>S service. Sulfide stress cracking (SSC) occurred along the toe of the weld (arrow), in a narrow zone of high hardness.**

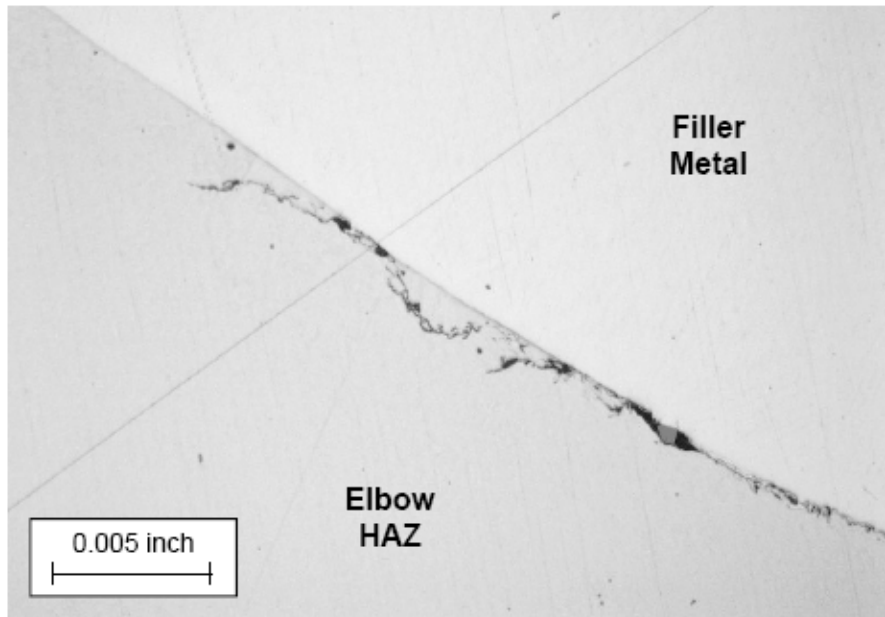


Figure 4-37 – High magnification photomicrograph of SSC in pipe section shown in Figure 4-36.



Figure 4-38 – Failure of DMW joining 1.25Cr-0.5Mo to Alloy 800H in a Hydro-dealkylation (HAD) Reactor Effluent Exchanger. Crack propagation due to stresses driven at high temperature of 875°F (468°C) and a hydrogen partial pressure of 280 psig (1.93 MPa).

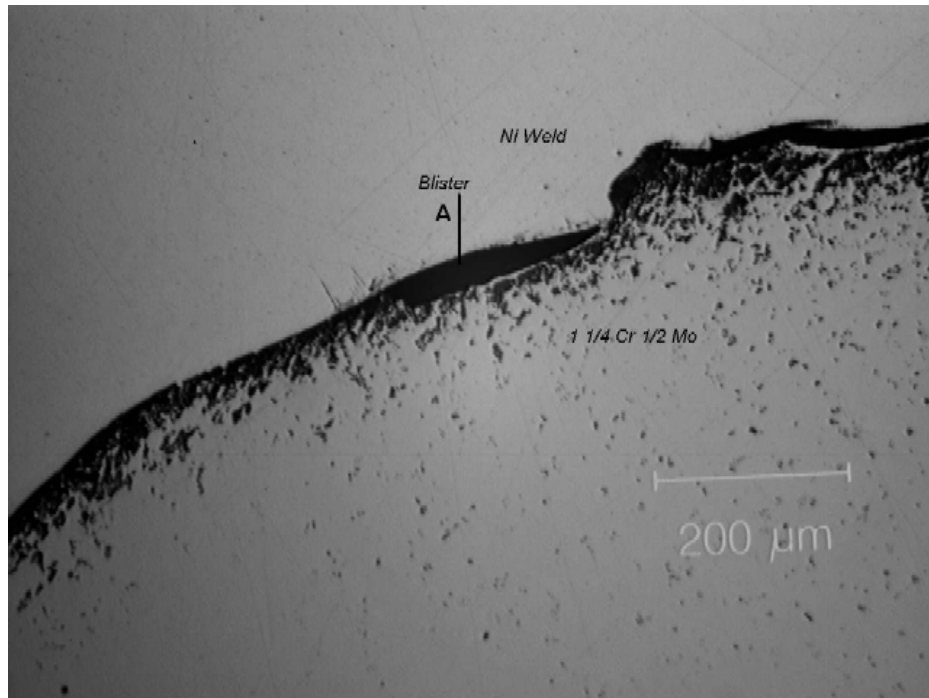


Figure 4-39 – High magnification photomicrograph of the crack in Figure 4-38 showing blistering and disbondment along the weld fusion line interface.

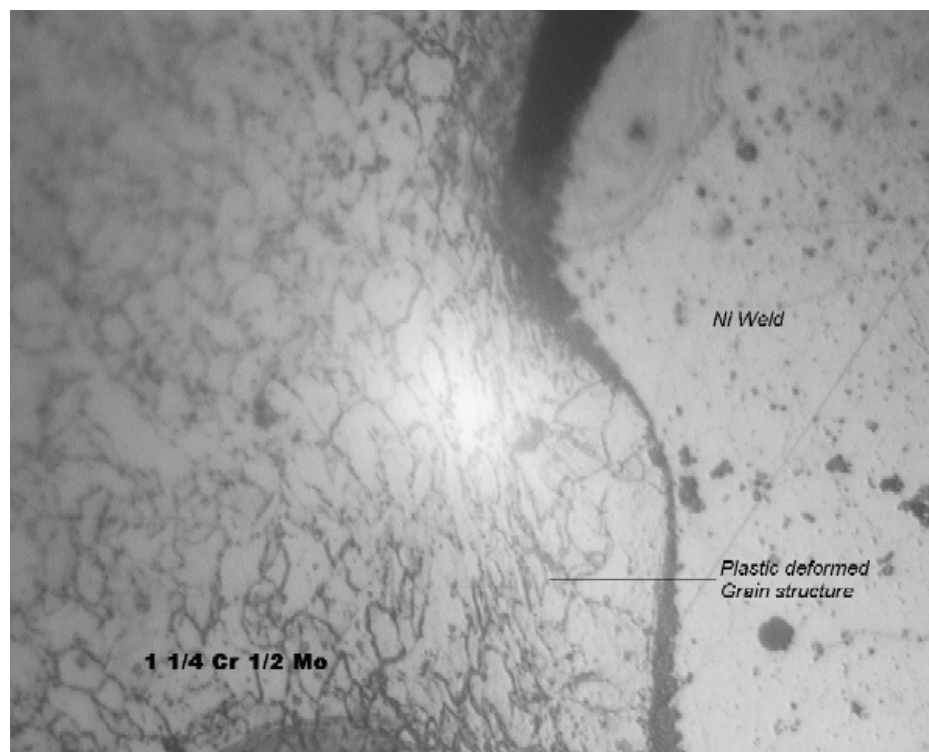
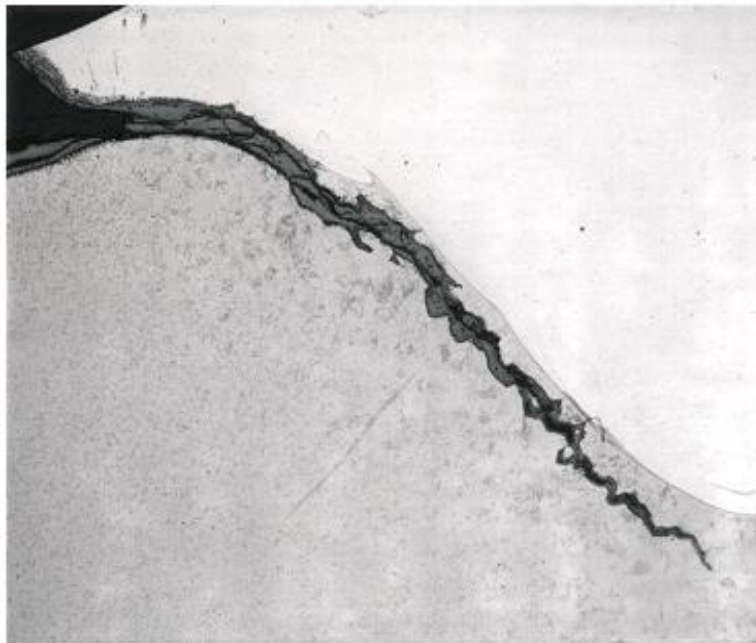


Figure 4-40 – High magnification photomicrograph of the crack shown above in Figure 4-39. Plastic deformation of the grain structure can be found at the vicinity of the blister.



**Figure 4-41 – Failure of nickel alloy DMW joining HP40 (Nb modified) tube to 1.25Cr-0.5Mo flange in a Steam Methane Reformer due to cold hydrogen disbonding of the buttering layer. Process temperature 914°-941°F (490° to 505°C), Pressure (2.14 Mpa), H<sub>2</sub> content 10-20% (off-gas).**



**Figure 4-42 – When both liquid phase coal ash corrosion and a DMW exists, stress assisted corrosion of the 2.25Cr-1Mo heat-affected zone may occur. Note that there is a lack of creep damage at the crack tip. Mag. 25X, etched.**

### **4.2.13 Thermal Shock**

#### **4.2.13.1 Description of Damage**

A form of thermal fatigue cracking – thermal shock – can occur when high and non-uniform thermal stresses develop over a relatively short time in a piece of equipment due to differential expansion or contraction. If the thermal expansion/contraction is restrained, stresses above the yield strength of the material can result. Thermal shock usually occurs when a colder liquid contacts a warmer metal surface.

#### **4.2.13.2 Affected Materials**

All metals and alloys.

#### **4.2.13.3 Critical Factors**

- a) The magnitude of the temperature differential and the coefficient of thermal expansion of the material determine the magnitude of the stress.
- b) Cyclic stresses generated by temperature cycling of the material may initiate fatigue cracks.
- c) Stainless steels have higher coefficients of thermal expansion than carbon and alloy steels or nickel base alloys and are more likely to see higher stresses.
- d) High temperature exposure during a fire.
- e) Temperature changes that can result from water quenching as a result of rain deluges.
- f) Fracture is related to constraint on a component that prevents the component from expanding or contracting with a change in temperature.
- g) Cracking in cast components such as valves may initiate at casting flaws on the ID and progress through the thickness.
- h) Thick sections can develop high thermal gradients.

#### **4.2.13.4 Affected Units or Equipment**

- a) FCC, cokers, catalytic reforming and high severity hydroprocessing units are high temperature units where thermal shock is possible.
- b) High temperature piping and equipment in any unit can be affected.
- c) Materials that have lost ductility, such as CrMo equipment (temper embrittlement) are particularly susceptible to thermal shock.
- d) Equipment subjected to accelerated cooling procedures to minimize shutdown time.

#### **4.2.13.5 Appearance or Morphology of Damage**

Surface initiating cracks may also appear as “craze” cracks.

#### **4.2.13.6 Prevention / Mitigation**

- a) Prevent interruptions in the flow of high temperature lines.
- b) Design to minimize severe restraint.
- c) Install thermal sleeves to prevent liquid impingement on the pressure boundary components.
- d) Minimize rain or fire water deluge situations.
- e) Review hot/cold injection points for potential thermal shock.

**4.2.13.7 Inspection and Monitoring**

- a) This type of damage is highly localized and difficult to locate.
- b) PT and MT can be used to confirm cracking.

**4.2.13.8 Related Mechanisms**

Thermal fatigue (see [4.2.9](#)).

**4.2.13.9 References**

1. ASM Metals Handbook, "Failure Analysis and Prevention," Volume 11, ASM International, Materials Park, OH.
2. API 579-1/ASME FFS-1 2007 *Fitness-For-Service*, American Petroleum Institute, Washington, D.C., 2007



#### 4.2.14 Erosion/Erosion – Corrosion

##### 4.2.14.1 Description of Damage

- a) Erosion is the accelerated mechanical removal of surface material as a result of relative movement between, or impact from solids, liquids, vapor or any combination thereof.
- b) Erosion-corrosion is a description for the damage that occurs when corrosion contributes to erosion by removing protective films or scales, or by exposing the metal surface to further corrosion under the combined action of erosion and corrosion.

##### 4.2.14.2 Affected Materials

All metals, alloys and refractories.

##### 4.2.14.3 Critical Factors

- a) In most cases, corrosion plays some role so that pure erosion (sometimes referred to as abrasive wear) is rare. It is critical to consider the role that corrosion contributes.
- b) Metal loss rates depend on the velocity and concentration of impacting medium (i.e., particles, liquids, droplets, slurries, two-phase flow), the size and hardness of impacting particles, the hardness and corrosion resistance of material subject to erosion, and the angle of impact.
- c) Softer alloys such as copper and aluminum alloys that are easily worn from mechanical damage may be subject to severe metal loss under high velocity conditions.
- d) Although increasing hardness of the metal substrate is a common approach to minimize damage, it is not always a good indicator of improved resistance to erosion, particularly where corrosion plays a significant role.
- e) For each environment-material combination, there is often a threshold velocity above which impacting objects may produce metal loss. Increasing velocities above this threshold result in an increase in metal loss rates as shown in [Table 4-5](#). This table illustrates the relative susceptibility of a variety of metals and alloys to erosion/corrosion by seawater at different velocities.
- f) The size, shape, density and hardness of the impacting medium affect the metal loss rate.
- g) Increasing the corrosivity of the environment may reduce the stability of protective surface films and increase the susceptibility to metal loss. Metal may be removed from the surface as dissolved ions, or as solid corrosion products which are mechanically swept from the metal surface.
- h) Factors which contribute to an increase in corrosivity of the environment, such as temperature, pH, etc., can increase susceptibility to metal loss.

##### 4.2.14.4 Affected Units or Equipment

- a) All types of equipment exposed to moving fluids and/or catalyst are subject to erosion and erosion-corrosion. This includes piping systems, particularly the bends, elbows, tees and reducers; piping systems downstream of letdown valves and block valves; pumps; blowers; propellers; impellers; agitators; agitated vessels; heat exchanger tubing; measuring device orifices; turbine blades; nozzles; ducts and vapor lines; scrapers; cutters; and wear plates.
- b) Erosion can be caused by gas borne catalyst particles or by particles carried by a liquid such as a slurry. In refineries, this form of damage occurs as a result of catalyst movement in FCC reactor/regenerator systems in catalyst handling equipment (valves, cyclones, piping, reactors) and slurry piping ([Figure 4-43](#)); coke handling equipment in both delayed and fluidized bed cokers ([Figure 4-44](#)); and as wear on pumps ([Figure 4-45](#)), compressors and other rotating equipment.
- c) Hydroprocessing reactor effluent piping may be subject to erosion-corrosion by ammonium bisulfide. The metal loss is dependent on several factors including the ammonium bisulfide concentration, velocity and alloy corrosion resistance.

- d) Crude and vacuum unit piping and vessels exposed to naphthenic acids in some crude oils may suffer severe erosion-corrosion metal loss depending on the temperature, velocity, sulfur content and TAN level.

#### **4.2.14.5 Appearance or Morphology of Damage**

- a) Erosion and erosion-corrosion are characterized by a localized loss in thickness in the form of pits, grooves, gullies, waves, rounded holes and valleys. These losses often exhibit a directional pattern.
- b) Failures can occur in a relatively short time.

#### **4.2.14.6 Prevention / Mitigation**

- a) Improvements in design involve changes in shape, geometry and materials selection. Some examples are: increasing the pipe diameter to decrease velocity; streamlining bends to reduce impingement; increasing the wall thickness; and using replaceable impingement baffles.
- b) Improved resistance to erosion is usually achieved through increasing substrate hardness using harder alloys, hardfacing or surface-hardening treatments. Erosion resistant refractories in cyclones and slide valves have been very successful.
- c) Erosion-corrosion is best mitigated by using more corrosion-resistant alloys and/or altering the process environment to reduce corrosivity, for example, deaeration, condensate injection or the addition of inhibitors. Resistance is generally not improved through increasing substrate hardness alone.
- d) Heat exchangers utilize impingement plates and occasionally tube ferrules to minimize erosion problems.
- e) Higher molybdenum containing alloys are used for improved resistance to naphthenic acid corrosion.

#### **4.2.14.7 Inspection and Monitoring**

- a) Visual examination of suspected or troublesome areas, as well as UT checks or RT can be used to detect the extent of metal loss.
- b) Specialized corrosion coupons and on-line corrosion monitoring electrical resistance probes have been used in some applications.
- c) IR scans are used to detect refractory loss on stream.

#### **4.2.14.8 Related Mechanisms**

Specialized terminology has been developed for various forms of erosion and erosion-corrosion in specific environments and/or services. This terminology includes cavitation, liquid impingement erosion, fretting and other similar terms.

#### **4.2.14.9 References**

1. ASM Metals Handbook, Volume 13, "Corrosion," ASM International, Materials Park, OH.
2. ASM Metals Handbook, Volume 11, "Failure Analysis and Prevention," ASM International, Metals Park, OH.

**Table 4-5 – Typical erosion-corrosion rates in seawater, mpy. (Reference 2)**

Material	1 fps (tidal current)	4 fps (Immersed in seawater flume)	27 fps (rotating disk)
Carbon steel	6	13	47
Cast iron	9	--	54
Silicon bronze	0.2	0.3	57
Admiralty brass	0.3	3	29
Hydraulic bronze	1	0.2	55
G bronze	1	0.3	46
Al bronze	1	--	44
Aluminum brass	0.4	--	19
90-10 CuNi	1	--	16
70-30 CuNi (0.05%Fe)	0.3	--	32
70-30 CuNi (0.5% Fe)	<0.2	<0.2	6
Monel	<0.2	<0.2	1
316 SS	0.2	0	<0.2
Hastelloy C	<0.2	--	0.05
Titanium	0	--	0



Figure 4-43 – Erosion Corrosion of a 1.25Cr 300 # valve flange on an FCC Catalyst withdrawal line.



Figure 4-44 – Erosion of a 9Cr-1Mo coker heater return bend.



**Figure 4-45 – Erosion-Corrosion of is ASTM A48 Class 30 Cast Iron Impeller in recycle water pump.**

## **4.2.15 Cavitation**

### **4.2.15.1 Description of Damage**

- a) Cavitation is a form of erosion caused by the formation and instantaneous collapse of innumerable tiny vapor bubbles.
- b) The collapsing bubbles exert severe localized impact forces that can result in metal loss referred to as cavitation damage.
- c) The bubbles may contain the vapor phase of the liquid, air or other gas entrained in the liquid medium.

### **4.2.15.2 Affected Materials**

Most common materials of construction including copper and brass, cast iron, carbon steel, low alloy steels, 300 Series SS, 400 Series SS and nickel base alloys.

### **4.2.15.3 Critical Factors**

- a) In a pump, the difference between the actual pressure or head of the liquid available (measured on the suction side) and the vapor pressure of that liquid is called the Net Positive Suction Head (NPSH) available. The minimum head required to prevent cavitation with a given liquid at a given flow rate is called the net positive suction head required. Inadequate NPSH can result in cavitation.
- b) Temperatures approaching the boiling point of the liquid are more likely to result in bubble formation than lower temperature operation.
- c) The presence of solid or abrasive particles is not required for cavitation damage but will accelerate the damage.

### **4.2.15.4 Affected Units or Equipment**

- a) Cavitation is most often observed in pump casings, pump impellers (low pressure side) and in piping downstream of orifices or control valves.
- b) Damage can also be found in restricted-flow passages or other areas where turbulent flow is subjected to rapid pressure changes within a localized region. Examples of affected equipment include heat exchanger tubes, venturis, seals and impellers.

### **4.2.15.5 Appearance or Morphology of Damage**

Cavitation damage generally looks like sharp-edged pitting but may also have a gouged appearance in rotational components. However, damage occurs only in localized low-pressure zones (see [Figure 4-46](#), [Figure 4-47](#) to [Figure 4-49](#)).

**4.2.15.6 Prevention / Mitigation**

- a) Resistance to cavitation damage in a specific environment may not be significantly improved by a material change. A mechanical modification, design or operating change is usually required.
- b) Cavitation is best prevented by avoiding conditions that allow the absolute pressure to fall below the vapor pressure of the liquid or by changing the material properties. Examples include:
  - 1) Streamline the flow path to reduce turbulence.
  - 2) Decrease fluid velocities.
  - 3) Remove entrained air.
  - 4) Increase the suction pressure of pumps.
  - 5) Alter the fluid properties, perhaps by adding additives.
  - 6) Use hard surfacing or hardfacing.
  - 7) Use of harder and/or more corrosion resistant alloys.
- c) Attack is accelerated by the mechanical disruption of protective films at the liquid-solid interface (such as a protective corrosion scale or passive films). Therefore, changing to a more corrosion resistant and/or higher hardness material may not improve cavitation resistance. Excessively hard materials may not be suitable if they lack the toughness required to withstand the high local pressures and impact (shear loads) of the collapsing bubbles.

**4.2.15.7 Inspection and Monitoring**

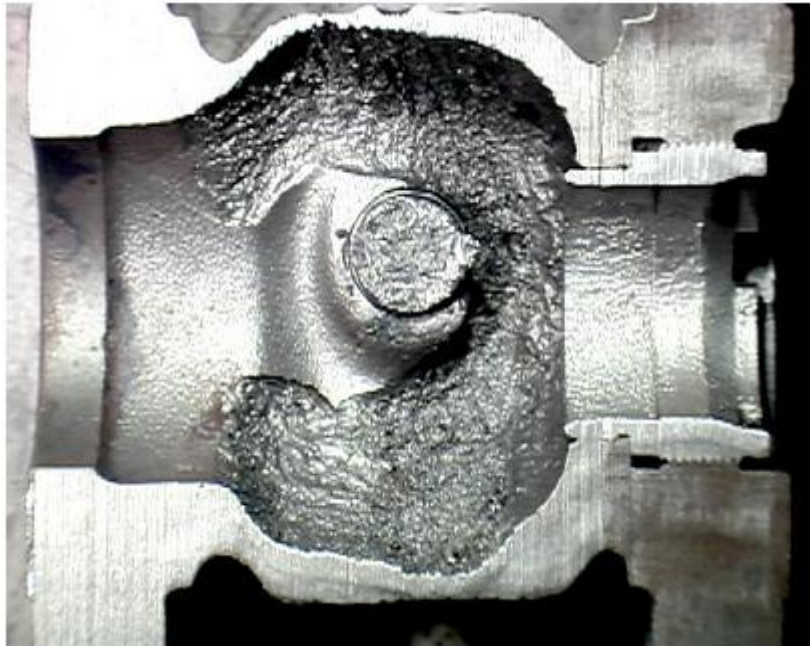
- a) Cavitating pumps may sound like pebbles are being thrashed around inside.
- b) Techniques include limited monitoring of fluid properties as well as acoustic monitoring of turbulent areas to detect characteristic sound frequencies.
- c) Visual examination of suspected areas, as well as external UT and RT can be used to monitor for loss in thickness.

**4.2.15.8 Related Mechanisms**

Liquid impingement or erosion (see [4.2.14](#)).

**4.2.15.9 References**

1. ASM Metals Handbook, "Evaluation of Erosion and Cavitation," Corrosion, Volume 13.
2. C.P. Dillon, "Corrosion Control in the Chemical Process Industries," MTI (printed by NACE), 1994.
3. V.R. Pludek, "Design and Corrosion Control," Macmillan Press LTD., 1979.



**Figure 4-46 – Cutaway of a CS butterfly valve with cavitation damage after two years of service due to a high pressure drop across the valve in a hydrocarbon drain line off a cold low pressure separator in an atmospheric resid desulfurizing unit.**



**Figure 4-47 – Closer view of damaged surface of butterfly valve.**





**Figure 4-48 – Cavitation pitting on the low-pressure side of a stainless steel pump impeller.**



**Figure 4-49 – Cavitation pitting on the water side of a cast iron cylinder liner in a large engine.**

## **4.2.16 Mechanical Fatigue**

### **4.2.16.1 Description of Damage**

- a) Fatigue cracking is a mechanical form of degradation that occurs when a component is exposed to cyclical stresses for an extended period, often resulting in sudden, unexpected failure.
- b) These stresses can arise from either mechanical loading or thermal cycling and are typically well below the yield strength of the material.

### **4.2.16.2 Affected Materials**

All engineering alloys are subject to fatigue cracking although the stress levels and number of cycles necessary to cause failure vary by material.

### **4.2.16.3 Critical Factors**

Geometry, stress level, number of cycles, and material properties (strength, hardness, microstructure) are the predominant factors in determining the fatigue resistance of a component.

- a) Design: Fatigue cracks usually initiate on the surface at notches or stress raisers under cyclic loading. For this reason, design of a component is the most important factor in determining a component's resistance to fatigue cracking. Several common surface features can lead to the initiation of fatigue cracks as they can act as stress concentrations. Some of these common features are:
  - 1) Mechanical notches (sharp corners or groves);
  - 2) Key holes on drive shafts of rotating equipment;
  - 3) Weld joint, flaws and/or mismatches;
  - 4) Quench nozzle areas;
  - 5) Tool markings;
  - 6) Grinding marks;
  - 7) Lips on drilled holes;
  - 8) Thread root notches;
  - 9) Corrosion.
- b) Metallurgical Issues and Microstructure
  - 1) For some materials such as titanium, carbon steel and low alloy steel, the number of cycles to fatigue fracture decreases with stress amplitude until an endurance limit reached. Below this stress endurance limit, fatigue cracking will not occur, regardless of the number of cycles.
  - 2) For alloys with endurance limits, there is a correlation between Ultimate Tensile Strength (UTS) and the minimum stress amplitude necessary to initiate fatigue cracking. The ratio of endurance limit over UTS is typically between 0.4 and 0.5. Materials like austenitic stainless steels and aluminum that do not have an endurance limit will have a fatigue limit defined by the number of cycles at a given stress amplitude.
  - 3) Inclusions found in metal can have an accelerating effect on fatigue cracking. This is of importance when dealing with older, "dirty" steels or weldments, as these often have inclusions and discontinuities that can degrade fatigue resistance.
  - 4) Heat treatment can have a significant effect on the toughness and hence fatigue resistance of a metal. In general, finer grained microstructures tend to perform better than coarse grained. Heat treatments such as quenching and tempering, can improve fatigue resistance of carbon and low alloy steels.

- c) Carbon Steel and Titanium: These materials exhibit an endurance limit below which fatigue cracking will not occur, regardless of the number of cycles.
- d) 300 Series SS, 400 Series SS, aluminum and most other non-ferrous alloys:
  - 1) These alloys have a fatigue characteristic that does not exhibit an endurance limit. This means that fatigue fracture can be achieved under cyclical loading eventually, regardless of stress amplitude.
  - 2) Maximum cyclical stress amplitude is determined by relating the stress necessary to cause fracture to the desired number of cycles necessary in a component's lifetime. This is typically 106 to 107 cycles.

#### **4.2.16.4 Affected Units or Equipment**

- a) Thermal Cycling
  - 1) Equipment that cycles daily in operation such as coke drums.
  - 2) Equipment that may be auxiliary or on continuous standby but sees intermittent service such as auxiliary boiler.
  - 3) Quench nozzle connections that see significant temperature deltas during operations such as water washing systems.
- b) Mechanical Loading
  - 1) Pressure Swing Absorbers on hydrogen purification units.
  - 2) Rotating shafts on centrifugal pumps and compressors that have stress concentrations due to changes in radii and key ways.
  - 3) Components such as small diameter piping that may see vibration from adjacent equipment and/or wind. For small components, resonance can also produce a cyclical load and should be taken into consideration during design and reviewed for potential problems after installation.
  - 4) High pressure drop control valves or steam reducing stations can cause serious vibration problems in connected piping.

#### **4.2.16.5 Appearance or Morphology of Damage**

- a) The signature mark of a fatigue failure is a "clam shell" type fingerprint that has concentric rings called "beach marks" emanating from the crack initiation site (Figure 4-50 and Figure 4-51). This signature pattern results from the "waves" of crack propagation that occur during cycles above the threshold loading. These concentric cracks continue to propagate until the cross-sectional area is reduced to the point where failure due to overload occurs.
- b) Cracks nucleating from a surface stress concentration or defect will typically result in a single "clam shell" fingerprint (Figure 4-52 to Figure 4-56).
- c) Cracks resulting from cyclical overstress of a component without significant stress concentration will typically result in a fatigue failure with multiple points of nucleation and hence multiple "clam shell" fingerprints. These multiple nucleation sites are the result of microscopic yielding that occurs when the component is momentarily cycled above its yield strength.

**4.2.16.6 Prevention / Mitigation**

- a) The best defense against fatigue cracking is good design that helps minimize stress concentration of components that are in cyclic service.
- b) Select a metal with a design fatigue life sufficient for its intended cyclic service.
- c) Allow for a generous radius along edges and corners.
- d) Minimize grinding marks, nicks and gouges on the surface of components.
- e) Insure good fit up and smooth transitions for welds. Minimize weld defects as these can accelerate fatigue cracking.
- f) Remove any burrs or lips caused by machining.
- g) Use low stress stamps and marking tools.

**4.2.16.7 Inspection and Monitoring**

- a) NDE techniques such as PT, MT and SWUT can be used to detect fatigue cracks at known areas of stress concentration.
- b) VT of small diameter piping to detect oscillation or other cyclical movement that could lead to cracking.
- c) Vibration monitoring of rotating equipment to help detect shafts that may be out of balance.
- d) In high cycle fatigue, crack initiation can be a majority of the fatigue life making detection difficult.

**4.2.16.8 Related Mechanisms**

Vibration induced fatigue (see [4.2.17](#)).

**4.2.16.9 References**

1. "Fracture and Fatigue Control in Structures," J.M. Barsom and S.T. Rolfe, American Society for Testing and Materials, West Conshohocken, PA.
2. ASTM STP1428, Thermo-mechanical Fatigue Behavior of Materials, American Society for Testing and Materials, West Conshohocken, PA.
3. ASTM MNL41, Corrosion in the Petrochemical Industry, ASM International, Materials Park, OH, 1995.

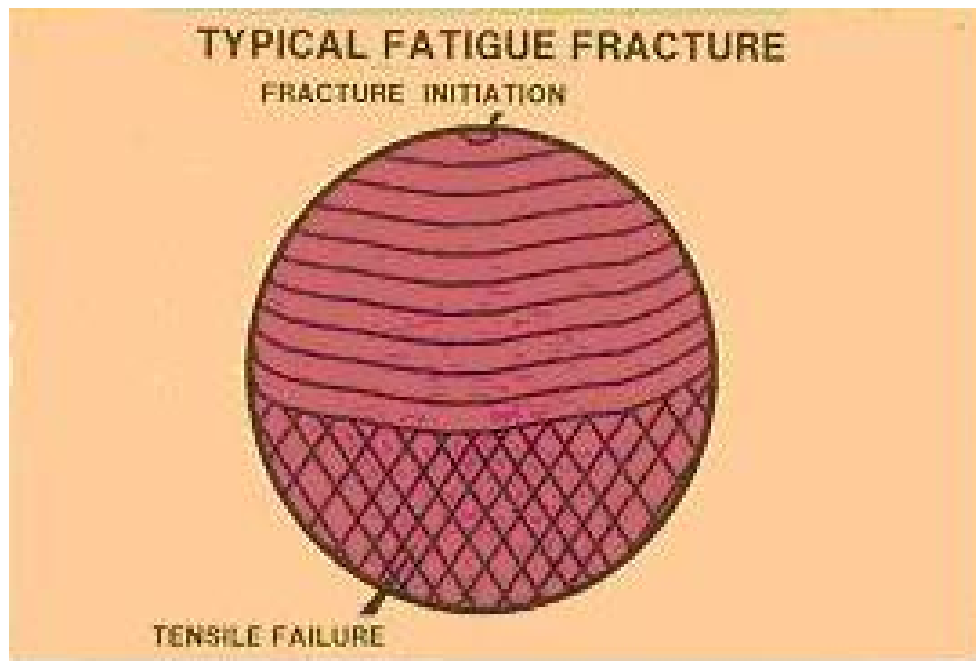


Figure 4-50 – Schematic of a fatigue fracture surface showing “beach marks”.

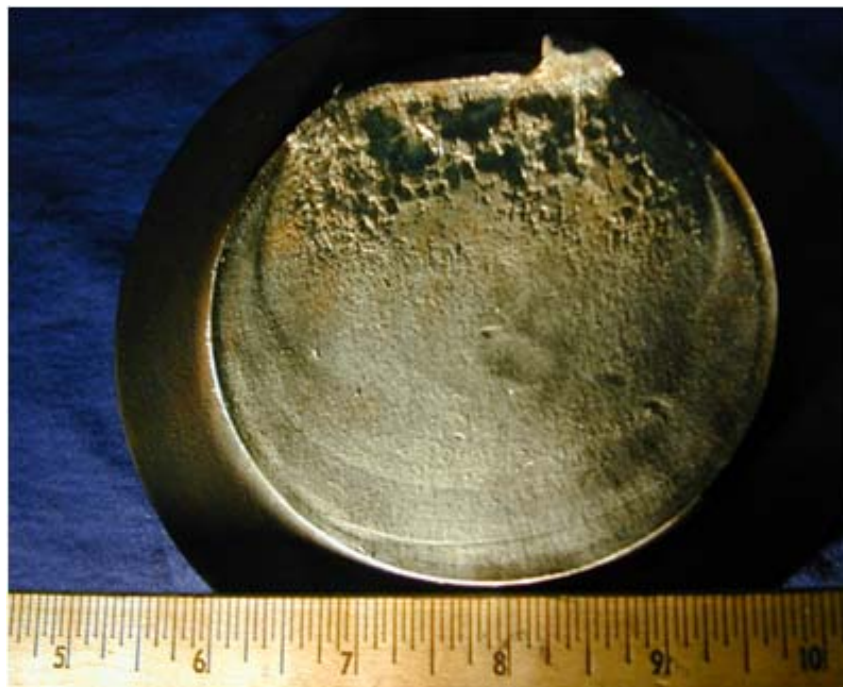


Figure 4-51 – Compressor rod fracture surface showing “beach marks”



Figure 4-52 – Higher magnification view of figure above showing “beach marks”.



Figure 4-53 – Fatigue fracture surface of a carbon steel pipe.

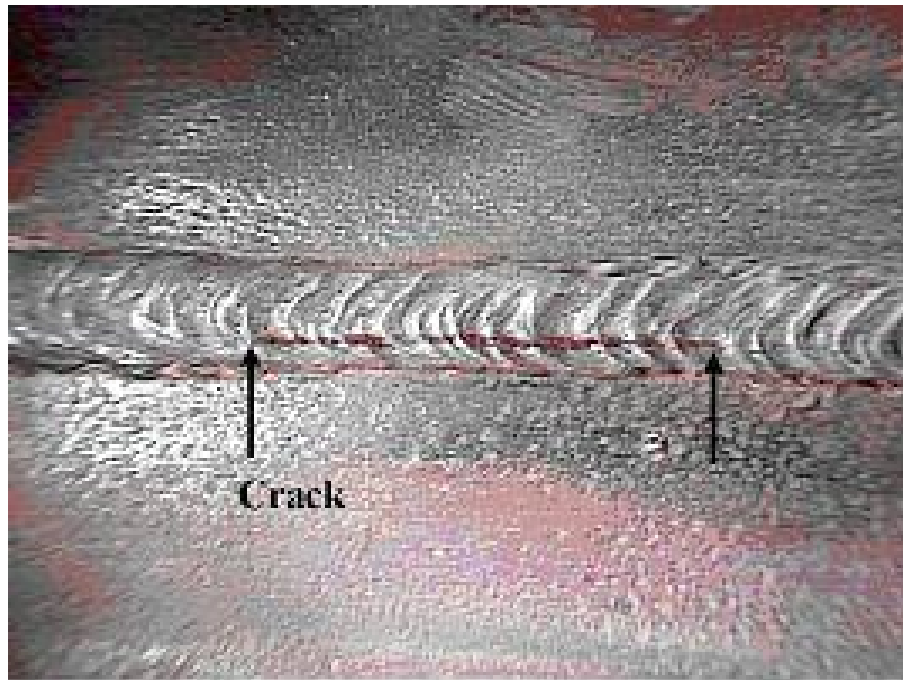


Figure 4-54 – Fatigue crack in a 16-inch pipe-to-elbow weld in the fill line of crude oil storage tank after 50 years in service.

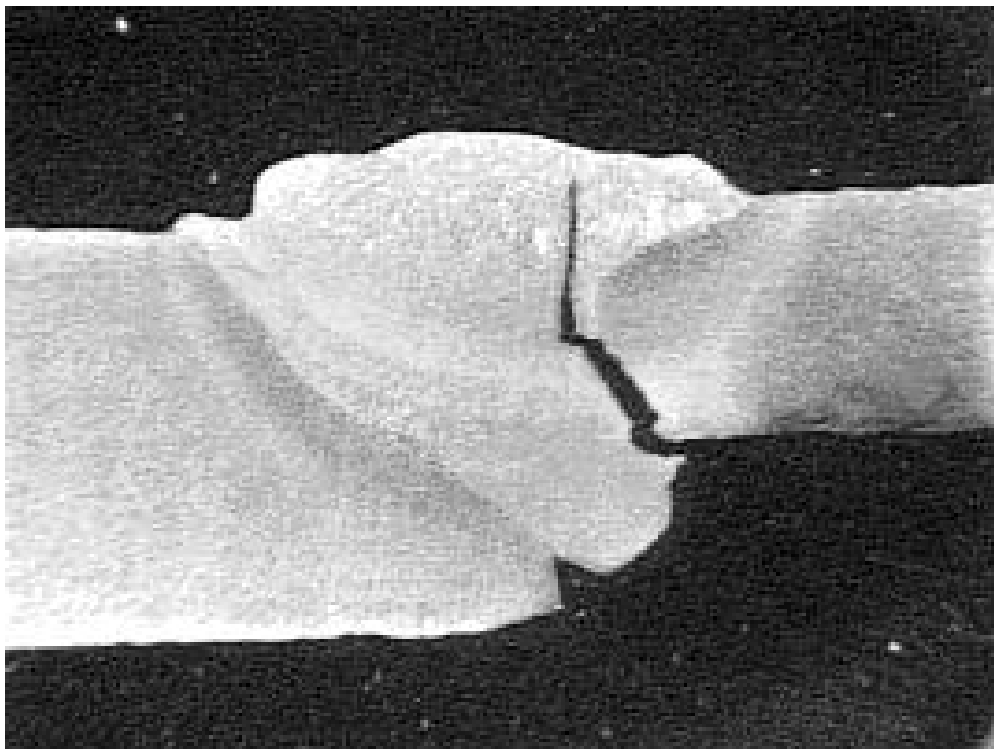
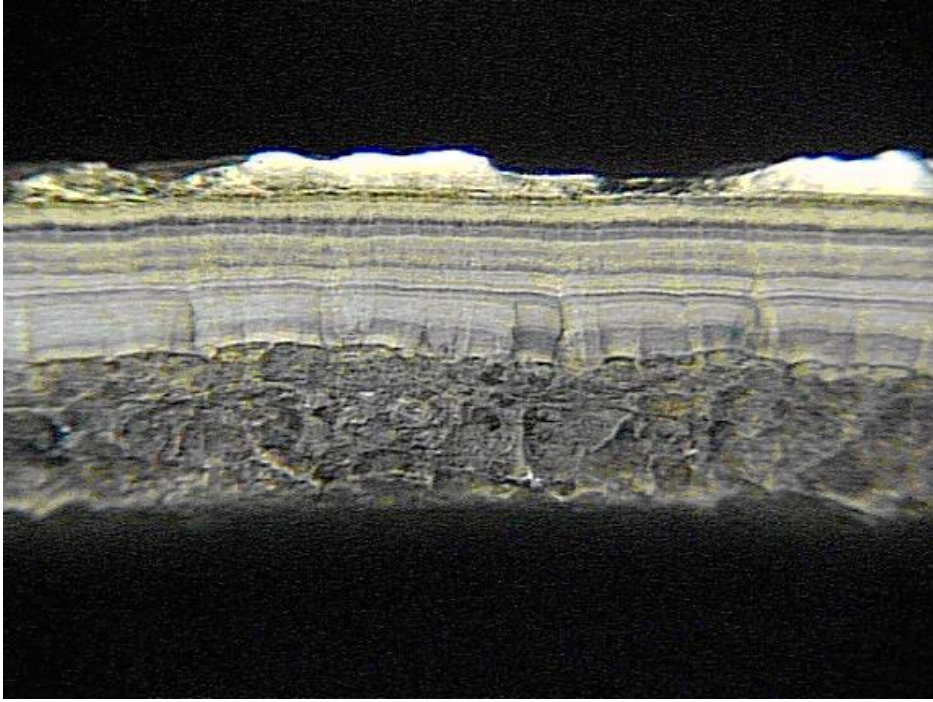


Figure 4-55 – A cross-section through the weld showing the crack location.



**Figure 4-56 – The surface of the fracture faces of the crack shown in Figure 4-54 and Figure 4-55.**



## **4.2.17 Vibration-Induced Fatigue**

### **4.2.17.1 Description of Damage**

A form of mechanical fatigue in which cracks are produced as the result of dynamic loading due to vibration, water hammer, or unstable fluid flow.

### **4.2.17.2 Affected Materials**

All engineering materials.

### **4.2.17.3 Critical Factors**

- a) The amplitude and frequency of vibration as well as the fatigue resistance of the components are critical factors.
- b) There is a high likelihood of cracking when the input load is synchronous or nearly synchronizes with the natural frequency of the component.
- c) A lack of or excessive support or stiffening allows vibration and possible cracking problems that usually initiate at stress raisers or notches.

### **4.2.17.4 Affected Units or Equipment**

- a) Socket welds and small bore piping at or near pumps and compressors that are not sufficiently gusseted.
- b) Small bore bypass lines and flow loops around rotating and reciprocating equipment.
- c) Small branch connections with unsupported valves or controllers.
- d) Safety relief valves are subject to chatter, premature pop-off, fretting and failure to operate properly.
- e) High pressure drop control valves and steam reducing stations.
- f) Heat exchanger tubes may be susceptible to vortex shedding.

### **4.2.17.5 Appearance or Morphology of Damage**

- a) Damage is usually in the form of a crack initiating at a point of high stress or discontinuity such as a thread or weld joint ([Figure 4-57](#) and [Figure 4-58](#)).
- b) A potential warning sign of vibration damage to refractories is the visible damage resulting from the failure of the refractory and/or the anchoring system. High skin temperatures may result from refractory damage.

### **4.2.17.6 Prevention / Mitigation**

- a) Vibration-induced fatigue can be eliminated or reduced through design and the use of supports and vibration dampening equipment. Material upgrades are not usually a solution.
- b) Install gussets or stiffeners on small bore connections. Eliminate unnecessary connections and inspect field installations.
- c) Vortex shedding can be minimized at the outlet of control valves and safety valves through proper side branch sizing and flow stabilization techniques.
- d) Vibration effects may be shifted when a vibrating section is anchored. Special studies may be necessary before anchors or dampeners are provided, unless the vibration is eliminated by removing the source.

**4.2.17.7 Inspection and Monitoring**

- a) Look for visible signs of vibration, pipe movement or water hammer.
- b) Check for the audible sounds of vibration emanating from piping components such as control valves and fittings.
- c) Conduct visual inspection during transient conditions (such as startups, shutdowns, upsets, etc.) for intermittent vibrating conditions.
- d) Measure pipe vibrations using special monitoring equipment.
- e) The use of surface inspection methods (such as PT, MT) can be effective in a focused plan.
- f) Check pipe supports and spring hangers on a regular schedule.
- g) Damage to insulation jacketing may indicate excessive vibration. This can result in wetting the insulation which will cause corrosion.

**4.2.17.8 Related Mechanisms**

Mechanical fatigue (see [4.2.16](#)) and refractory degradation (see [4.2.18](#)).

**4.2.17.9 References**

1. "Environmental Effects on Components: Commentary for ASME Section III," EPRI NP-5775, Project 1757-61, Final Report, EPRI, CA, 1998.
2. API RP 581, Risk-Based Inspection Technology, American Petroleum Institute, Washington, D.C., 2008.



Figure 4-57 – Vibration induced fatigue of a 1-inch socket weld flange in a thermal relief system shortly after startup.

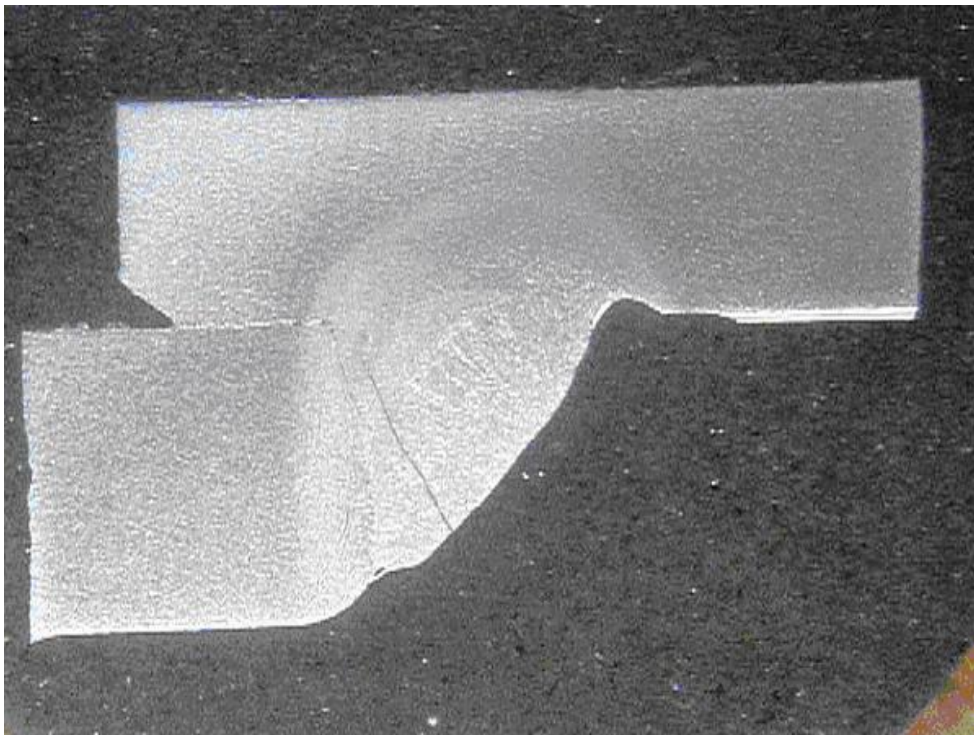


Figure 4-58 – Cross-sectional view of the crack in the socket weld in Figure 4-57.

## **4.2.18 Refractory Degradation**

### **4.2.18.1 Description of Damage**

Both thermal insulating and erosion resistant refractories are susceptible to various forms of mechanical damage (cracking, spalling and erosion) as well as corrosion due to oxidation, sulfidation and other high temperature mechanisms.

### **4.2.18.2 Affected Materials**

Refractory materials include insulating ceramic fibers, castables, refractory brick and plastic refractories.

### **4.2.18.3 Critical Factors**

- a) Refractory selection, design and installation are the keys to minimizing damage.
- b) Refractory lined equipment should be designed for erosion, thermal shock and thermal expansion.
- c) Dry out schedules, cure times and application procedures should be in accordance with the manufacturer's specifications and the appropriate ASTM requirements.
- d) Anchor materials must be compatible with thermal coefficients of expansion of the base metal.
- e) Anchors must be resistant to oxidation in high temperature services.
- f) Anchors must be resistant to condensing sulfurous acids in heaters and flue gas environments.
- g) Refractory type and density must be selected to resist abrasion and erosion based on service requirements.
- h) Needles and other fillers must be compatible with the process environment composition and temperature.

### **4.2.18.4 Affected Units or Equipment**

- a) Refractories are extensively used in FCC reactor regenerator vessels, piping, cyclones, slide valves and internals; in fluid cokers; in cold shell catalytic reforming reactors; and in waste heat boilers and thermal reactors in sulfur plants.
- b) Boiler fire boxes and stacks which also use refractory are affected.

### **4.2.18.5 Appearance or Morphology of Damage**

- a) Refractory may show signs of excessive cracking, spalling or lift-off from the substrate, softening or general degradation from exposure to moisture.
- b) Coke deposits may develop behind refractory and promote cracking and deterioration.
- c) In erosive services, refractory may be washed away or thinned, exposing the anchoring system. (Figure 4-59)

### **4.2.18.6 Prevention / Mitigation**

Proper selection of refractory, anchors and fillers and their proper design and installation are the keys to minimizing refractory damage.

### **4.2.18.7 Inspection and Monitoring**

- a) Conduct visual inspection during shutdowns.
- b) Survey cold-wall equipment onstream using IR to monitor for hot spots to help identify refractory damage.

**4.2.18.8 Related Mechanisms**

Oxidation (see [4.4.1](#)), sulfidation (see [4.4.2](#)) and flue gas dew point corrosion (see [4.3.7](#)).

**4.2.18.9 References**

1. R.A. White and E.F. Ehmke, "Materials Selection for Refineries and Associated Facilities," NACE International, Houston, TX, 1991, pp. 33,57.



**Figure 4-59 – Damaged refractory and ferrules.**

## 4.2.19 Reheat Cracking

### 4.2.19.1 Description of Damage

Cracking of a metal due to stress relaxation during Post Weld Heat Treatment (PWHT) or in service at elevated temperatures above 750°F (399°C). It is most often observed in heavy wall sections.

### 4.2.19.2 Affected Materials

Low alloy steels, especially the Cr-Mo steels with vanadium added, as well as 300 Series SS and nickel base alloys such as Alloy 800H.

### 4.2.19.3 Critical Factors

Important parameters include the type of material (chemical composition, impurity elements), grain size, residual stresses from fabrication (cold working, welding), section thickness (which controls restraint and stress state), notches and stress concentrators, weld metal and base metal strength, welding and heat treating conditions.

From the various theories of reheat cracking for both 300 Series SS and low alloy steels, cracking features are as follows:

- a) Reheat cracking requires the presence of high stresses and is therefore more likely to occur in thicker sections and higher strength materials.
- b) Reheat cracking occurs at elevated temperatures when creep ductility is insufficient to accommodate the strains required for the relief of applied or residual stresses.
- c) In the first half of 2008, numerous cases of reheat cracking occurred during 2 ¼ Cr-1 Mo-V reactor fabrication. The cracks were in weld metal only, transverse to the welding direction, and in only SAW welds. It was traced to a contaminant in the welding flux.
- d) Reheat cracking can either occur during PWHT or in service at high temperature. In both cases, cracks are intergranular and show little or no evidence of deformation.
- e) Fine intragranular precipitate particles make the grains stronger than the grain boundaries and force the creep deformation to occur at the grain boundaries.
- f) Stress relief and stabilization heat treatment of 300 Series SS for maximizing chloride SCC and PTASCC resistance can cause reheat cracking problems, particularly in thicker sections.

### 4.2.19.4 Affected Units or Equipment

- a) Reheat cracking is most likely to occur in heavy wall vessels in areas of high restraint including nozzle welds and heavy wall piping.
- b) HSLA steels are very susceptible to reheat cracking.

### 4.2.19.5 Appearance or Morphology of Damage

- a) Reheat cracking is intergranular and can be surface breaking or embedded depending on the state of stress and geometry. It is most frequently observed in coarse-grained sections of a weld heat-affected zone.
- b) In many cases, cracks are confined to the heat-affected zone, initiate at some type of stress concentration, and may act as an initiation site for fatigue. [Figure 4-60](#) to [4-63](#).

**4.2.19.6 Prevention / Mitigation**

- a) Joint configurations in heavy wall sections should be designed to minimize restraint during welding and PWHT. Adequate preheat must also be applied.
- b) The grain size has an important influence on the high temperature ductility and on the reheat cracking susceptibility. A large grain size results in less ductile heat-affected zones, making the material more susceptible to reheat cracking.
- c) Metallurgical notches arising from the welding operation are frequently the cause of heat-affected zone cracking (at the boundary between the weld and the heat-affected zone).
- d) In design and fabrication, it is advisable to avoid sharp changes in cross section, such as short radius fillets or undercuts that can give rise to stress concentrations. Long-seam welds are particularly susceptible to mismatch caused by fitup problems.
- e) For 2 ¼ Cr-1 Mo-V SAW weld materials, prequalification screening tests for reheat cracking such as high temperature (650°C) Gleeble tensile tests should be considered.
- f) For Alloy 800H, the risk of in-service cracking can be reduced by using base metal and matching weld metal with Al+Ti <0.7%.
- g) For Alloy 800H which will operate >540°C, the material may need to be purchased with a thermal stabilization heat treatment, and with PWHT of welds and cold worked sections. Welds should be made with matching Alloy 800H filler material and should be stress relieved. Refer to ASME Section VIII, Div. 1 Code in UNF-56(e) for additional information.
- h) For thick-wall SS piping, PWHT should be avoided whenever possible.

**4.2.19.7 Inspection and Monitoring**

- a) Surface cracks can be detected with UT and MT examination of carbon and low alloy steels
- b) UT and PT examination can be used to detect cracks in 300 Series SS and nickel base alloys.
- c) Embedded cracks can only be found through UT examination.
- d) Inspection for reheat cracking in 2 ¼ Cr-1 Mo-V reactors during fabrication is typically done with TOFD or manual shearwave UT with the demonstration block having defects as small as 3 mm side drilled holes

**4.2.19.8 Related Mechanisms**

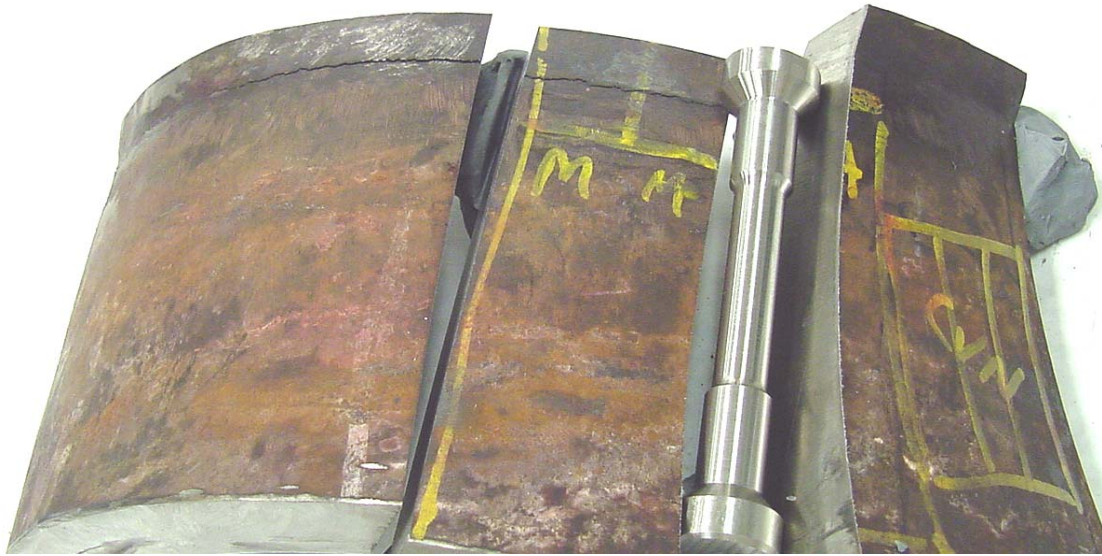
Reheat cracking has also been referred to in the literature as “stress relief cracking” and “stress relaxation cracking”.



---

**4.2.19.9 References**

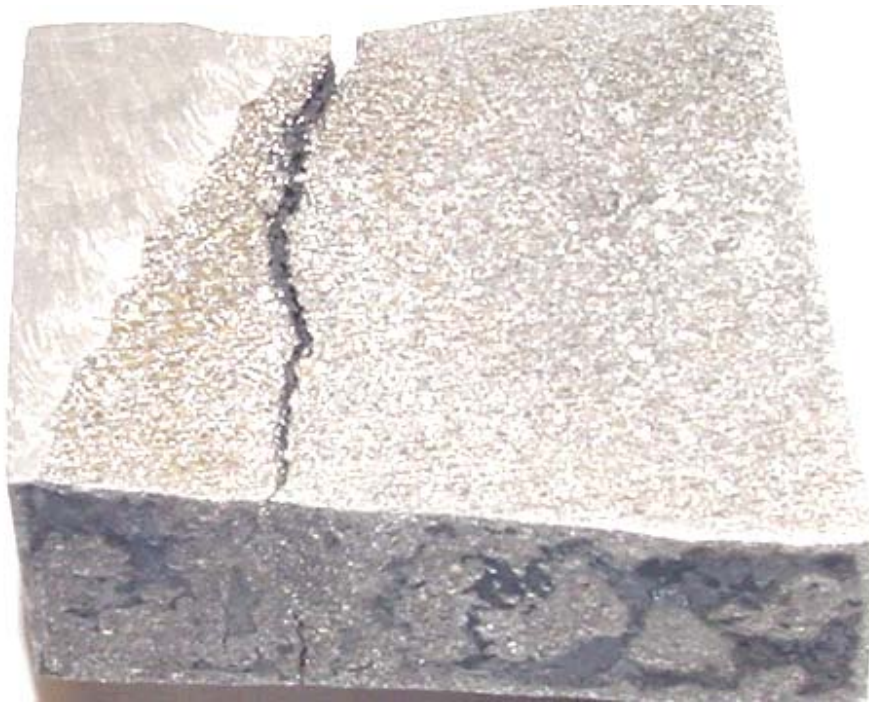
1. R. Viswanathan, "Damage Mechanisms and Life Assessment of High Temperature Components," ASM International, Materials Park, OH.
2. D.N. French, "Metallurgical Failures in Fossil Fired Boilers," Second Edition, John Wiley and Sons, NY, 1993, pp. 455 – 458.
3. A. Dhooge, "Survey on Reheat Cracking in Austenitic Stainless Steels and Ni Base Alloys," IIW-Commission IX, Doc. IX-1876-97.
4. C. D. Lundin and D K. K. Khan, "Fundamental Studies Of The Metallurgical Causes And Mitigation Of Reheat Cracking In 1¼Cr-½Mo And 2¼Cr-1Mo Steels", WRC Bulletin 409, Welding Research Council, Shaker Heights, OH..
5. C. Shargay and A. Singh, "Thick wall stainless steel piping in hydroprocessing units - heat treatment issues", NACE International, Paper #02478, Houston, TX, 2002.
6. M. E. Fahrion et al., "Technical basis for improved reliability of 347H stainless steel heavy wall piping in hydrogen service", NACE International, Paper #03647, Houston, TX, 2003.
7. John J. Hoffman, George Y. Lai, "METALLURGICAL EVALUATION OF ALLOY 800HT PIGTAILS", NACE International, Paper #05402, Houston, TX, 2005.
8. H. Van Wortel, "Control of relaxation cracking in austenitic high temperature components", Paper #07423, Houston, TX, 2007.
9. C. E. van der Westhuizen, "Stress relaxation cracking of welded joints in thick sections of a TP347 stabilized grade of stainless steel", NACE International, Paper #08454, Houston, TX, 2008.



**Figure 4-60 – Samples removed from a cracked 12-inch NPS 321SS elbow in hot recycle H<sub>2</sub> line that operated at 985°F in hydrocracker.**



**Figure 4-61 – Crack at weld from SS321 elbow shown in the Figure 4-60.**



**Figure 4-62 – Cross-section through the weldment showing the crack in Figure 4-61.**

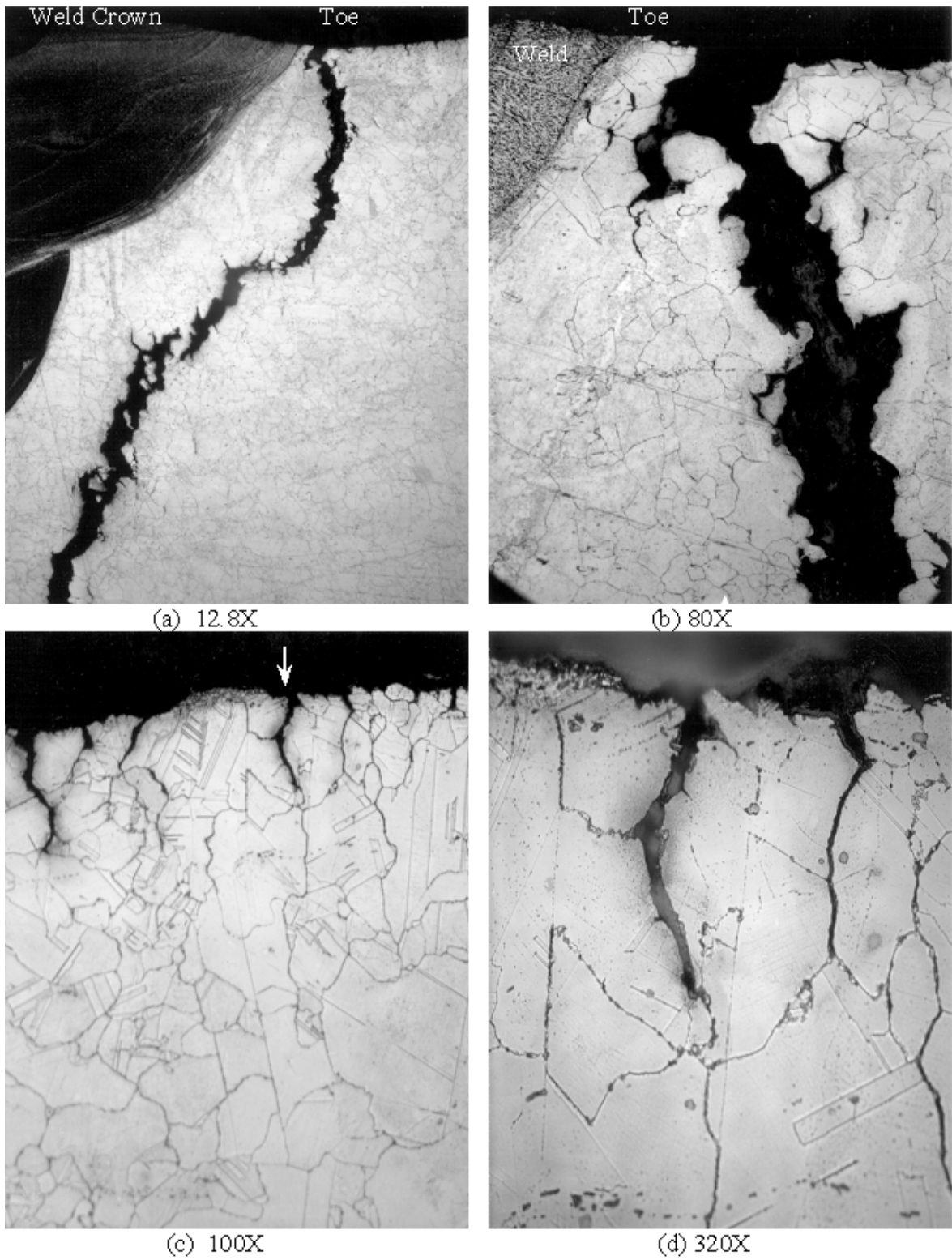


Figure 4-63 – Photomicrographs of the weldment area.

## 4.2.20 Gaseous Oxygen-Enhanced Ignition and Combustion

### 4.2.20.1 Description of Damage

Many metals are flammable in oxygen and enriched air (>25% oxygen) services even at low pressures, whereas they are non-flammable in air. The spontaneous ignition or combustion of metallic and non-metallic components can result in fires and explosions in certain oxygen-enriched gaseous environments if not properly designed, operated and maintained. Once ignited, metals and non-metals burn more vigorously with higher oxygen purity, pressure and temperature.

### 4.2.20.2 Affected Materials

- a) Carbon steels and low alloy steels are flammable in low pressure oxygen, greater than about 15 psig (0.103 MPa). With special precautions, these materials are safely used in high pressure oxygen.
- b) Austenitic stainless steels (300 series) have better resistance to low pressure oxygen and are generally difficult to ignite at pressures below about 200 psig (1.38 MPa).
- c) Copper alloys (with >55% copper) and nickel alloys (with >50% nickel) are very fire resistant and are generally considered non-flammable. Because of their excellent oxygen “compatibility” they are often selected for impingement and turbulent services such as valves and instrumentation (Figure 4-69). Alloy 400 is highly resistant.
- d) Although widely used for oxygen cylinders and in oxygen manufacturing plants, aluminum is usually avoided for flowing oxygen. If ignited it burns quickly and with a large energy release.
- e) The easiest materials to ignite are plastics, rubbers, and hydrocarbon lubricants and these are minimized in oxygen systems.
- f) Titanium alloys are generally avoided in oxygen and oxygen-enriched service because they have low ignition energies and release a large amount of energy during combustion. Tests indicate that titanium can sustain combustion at oxygen pressure as low as 7 kPa (1 psi) absolute. Most industry documents caution against the use of titanium in oxygen systems (References 6 and 7).

Note: These are general guidelines and should not be considered for design.

### 4.2.20.3 Critical Factors

- a) Many factors affect the likelihood of combustion and ignition in oxygen services including the system pressure, oxygen content of the stream, line velocity, component thickness, design and piping configuration, cleanliness and temperature.
- b) The primary concern under high velocity oxygen flow conditions is the entrainment of particulate and their subsequent impingement on a surface, such as at a pipe bend. Oxygen velocities in carbon steel and stainless steel piping should comply with industry limits as shown in Reference 1. Allowable velocity is a function of pressure and flow condition (direct impingement or non-impingement).
- c) The temperature of a material affects its flammability. As temperature increases, a lower amount of additional energy is required for ignition and sustained combustion. The minimum temperature at which a substance will support combustion, under a specific set of conditions is referred to as the ignition temperature. Published ignition temperatures for most alloys are near the alloy’s melting temperature. However, these are measured in non-flowing conditions. Actual systems can suffer ignition and combustion at room temperature (and lower) due to particle impact and other mechanisms.
- d) System cleanliness is important for the safe operation of oxygen systems. Contamination of with metallic fines or hydrocarbons such as oils and greases during construction or maintenance activities can lead to fires during subsequent start up of the unit. These materials are easy to ignite and can lead to a large fire and breach of the system.

- e) Impingement areas such as sharp elbows, tees and valves have a higher risk of ignition than straight pipe. Particles in the flowing oxygen can strike these areas and cause ignition. Operation of valves and regulators (opening / closing) cause high turbulence and impingement and only components selected and cleaned specifically for oxygen service should be used.

#### **4.2.20.4 Affected Units or Equipment**

- a) These guidelines apply to any unit that uses oxygen or enriched air for combustion or other process reasons.
- b) Oxygen is sometimes used in sulfur recovery units (SRU) and fluid catalytic cracking units (FCCU), Gasification, and Partial Oxidation (POX) units. [Figures 4-64 to 4-66](#).
- c) Oxygen piping systems especially valves, regulators, and other impingement areas are potentially vulnerable. Non-metals such as those used for seats and seals, are easier to ignite than metals ([Figure 4-69](#)).

#### **4.2.20.5 Appearance or Morphology of Damage**

- a) In some cases a small component will burn, such as a valve seat, without kindling other materials and without any outward sign of fire damage. It is noticed when the component is removed because it is not functioning properly. [Figure 4-67 to 4-68](#).
- b) Also, external heat damage (glowing pipe or heat tint) is a strong indication of an internal fire. This can be caused by accumulation of flammable debris at a low point or other location and combustion or smoldering of the debris.
- c) The worst situation is when the pressure envelope is breached because of fire. Oxygen fires can cause significant burning of metal components and extensive structural damage ([Figure 4-68](#)).

#### **4.2.20.6 Prevention / Mitigation**

Refer to industry recommended guidelines included in the references listed below. Some general considerations are as follows:

- a) Oxygen fires are a sudden occurrence and not a progressive degradation or weakening of the material. Prevention is best accomplished by keeping systems clean, or cleaning them after maintenance or inspections.
- b) Maintain velocity within recommended limits. If practical, avoid velocities that are nominally above 100 feet/second (30 m/sec) in gaseous oxygen.
- c) Ensure that replacement components are suitable for oxygen service.
- d) Oxygen systems should be thoroughly cleaned after maintenance.
- e) Minimize lubricants and use only "oxygen compatible" lubricants.
- f) Do not unnecessarily open oxygen systems for visual or other inspections as this could introduce contamination.
- g) A thorough review is needed before modifying oxygen systems to operate at higher pressures, temperatures, or velocities.
- h) Minimize sudden changes in pressure in the system. If high pressure oxygen suddenly enters a system initially at low pressure by quick operation of a valve, the "dead end" of that system experiences heating from adiabatic compression of the oxygen. Adiabatic compression heating can ignite plastics and rubbers, but will not ignite metals. Valve seats, seals, non-metallic hoses, etc can be ignited by this mechanism.
- i) Do not use plastic pipe in oxygen piping systems.
- j) Personnel activities near oxygen piping and systems should be minimized during start ups.

**4.2.20.7 Inspection and Monitoring**

- a) Most commercial oxygen is dry and non-corrosive at normal ambient temperatures. Because of the sudden catastrophic ignition of metals under certain conditions this type of damage is difficult to inspect for in advance.
- b) Tell-tale signs of a minor fire such as external heat damage, or signs of malfunctioning valves or other components containing non-metallic components may be indicative of a problem.
- c) Blacklights can be used to check for hydrocarbon contamination.

**4.2.20.8 Related Mechanisms**

Not applicable.

**4.2.20.9 References**

1. Compressed Gas Association Pamphlet G-4.4, "Industrial Practices for Gaseous Oxygen Transmission and Distribution Piping Systems."
2. ASTM G88, Standard Guide for Designing Systems for Oxygen Service;
3. ASTM G93, Standard Practice for Cleaning Methods for Material and Equipment Used in Oxygen Enriched Service.
4. CGA G-4.1, Cleaning Equipment for Oxygen Service Compressed Gas Association, latest edition.
5. CGA G-4.4, Industrial Practices for Gaseous Oxygen Transmission and Distribution Piping Systems, Compressed Gas Association, latest edition.
6. NFPA 53M, Manual on Fire Hazards in Oxygen-Enriched Atmospheres.
7. ASTM MNL 36, Safe Use of Oxygen and Oxygen Systems: Handbook for Design, Operation, and Maintenance, 2nd Edition, H. D. Beeson, S. R. Smith, and W. F. Stewart, Editors, 2007.



**Figure 4-64 – Thermal combustor on the front end of a reaction furnace on a sulfur recovery unit.**

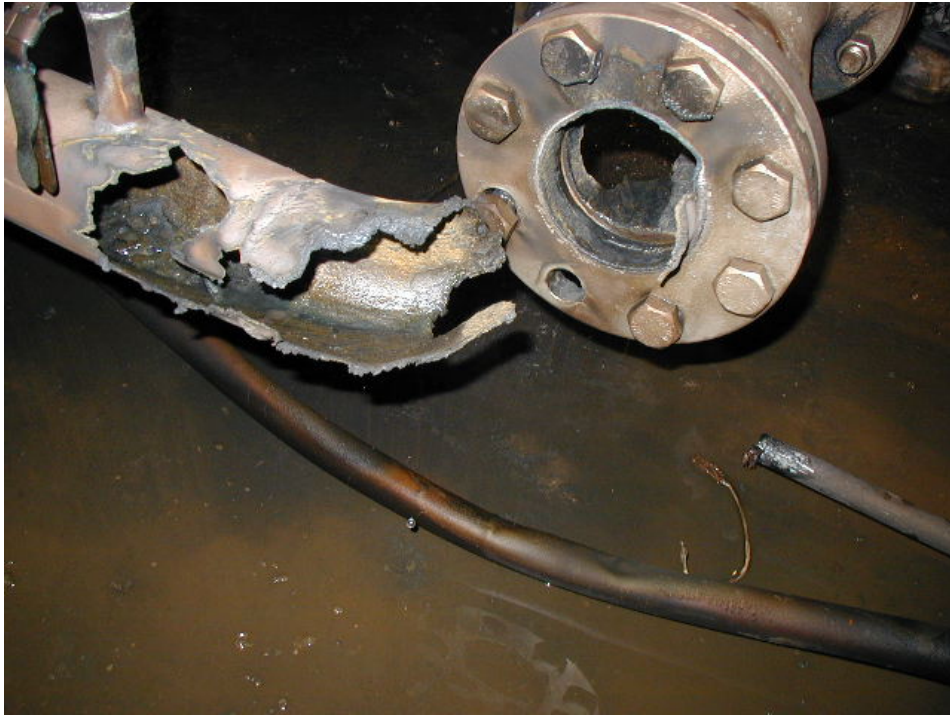




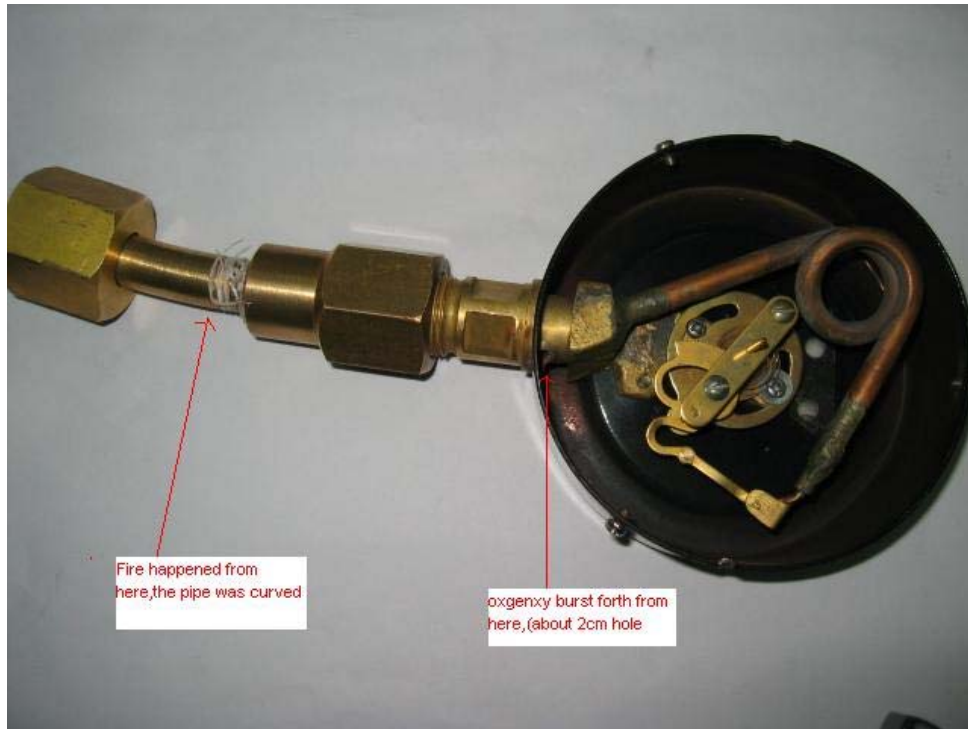
**Figure 4-65 – Same as figure above after damage due to oxygen combustion resulting from oxygen injection into the thermal combustor on the front end of the reaction furnace.**



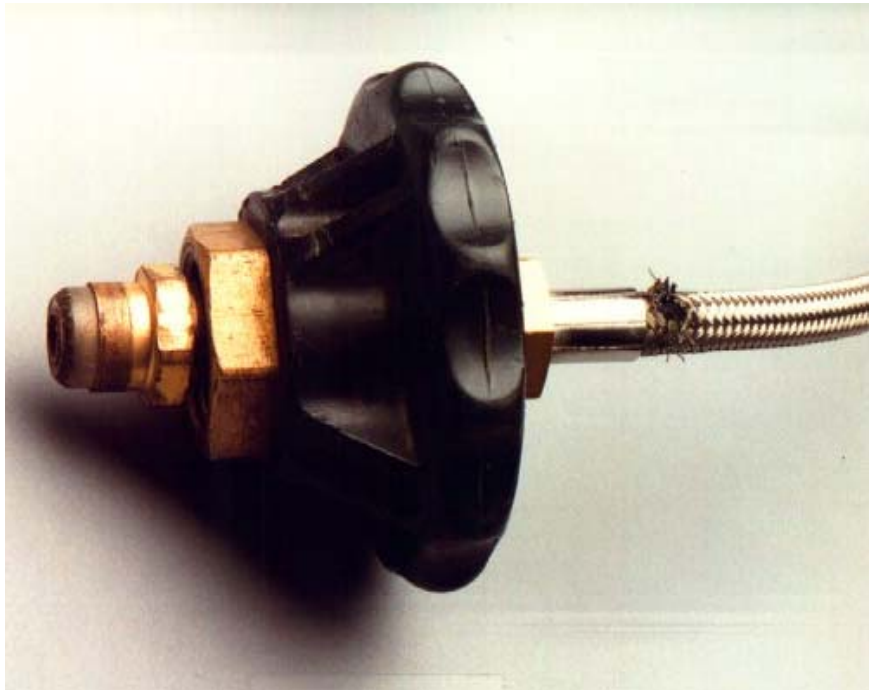
**Figure 4-66 – Same as figure above when viewed from a different angle.**



**Figure 4-67 – Photograph of a burned 304 SS elbow. The fire started in an upstream stainless steel wire filter (due to particle impact) and the burning filter material impacted the elbow and ignited it. Thin stainless steel components (e.g., filter) are much more flammable than thicker SS. Thin SS (<math><1/8''</math>) is usually avoided in oxygen systems.**



**Figure 4-68 – Photograph illustrating burn through of a brass pressure gage. Brass is generally suitable for oxygen service. However, the gauge was not intended for oxygen service and was not “oil free”. Hydrocarbon contamination, probably from manufacture, caused the fire.**



**Figure 4-69 – Burnthrough of a PTFE-lined stainless steel hose in high pressure gaseous oxygen (GOX) service. Grease contamination ignited and penetrated the hose.**

### 4.3 Uniform or Localized Loss of Thickness

#### 4.3.1 Galvanic Corrosion

##### 4.3.1.1 *Description of Damage*

A form of corrosion that can occur at the junction of dissimilar metals when they are joined together in a suitable electrolyte, such as a moist or aqueous environment, or soils containing moisture.

##### 4.3.1.2 *Affected Material*

All metals with the exception of most noble metals.

##### 4.3.1.3 *Critical Factors*

- a) For galvanic corrosion, three conditions must be met:
  - 1) Presence of an electrolyte, a fluid that can conduct a current. Moisture or a separate water phase is usually required for the solution to have enough conductivity.
  - 2) Two different materials or alloys known as the anode and the cathode, in contact with an electrolyte.
  - 3) An electrical connection must exist between the anode and the cathode.
- b) The more noble material (cathode) is protected by sacrificial corrosion of the more active material (anode). The anode corrodes at a higher rate than it would if it were not connected to the cathode.
- c) A typical listing of the relative position of alloys in seawater is shown in [Table 4-6](#).
- d) The farther the alloys are apart in the table, the higher the driving force for corrosion.
- e) The relative exposed surface areas between anodic material and the cathodic material has a significant affect.
  - 1) Corrosion rates of the anode can be high, if there is a small anode to cathode ratio.
  - 2) Corrosion rates of the anode will be less affected if there is a large anode to cathode ratio.
  - 3) If there is a galvanic couple, the more noble material may need to be coated. If the active material were coated, a large cathode to anode area can accelerate corrosion of the anode at any breaks in the coating.
  - 4) The same alloy may act as both an anode and a cathode due to surface films, scale, and/or local environment (for example, old steel pipe connected to new steel pipe).

##### 4.3.1.4 *Affected Units or Equipment*

- a) Galvanic corrosion can occur in any unit where there is a conductive fluid and alloys are coupled. Heat exchangers are susceptible if the tube material is different from the tubesheet and/or baffles, particularly if salt water cooling is utilized.
- b) Buried pipelines, electrical transmission support towers and ship hulls are typical locations for galvanic corrosion.

##### 4.3.1.5 *Appearance or Morphology of Damage*

- a) Damage occurs where two materials are joined at welded or bolted connections.
- b) The more active material can suffer generalized loss in thickness or may have the appearance of a crevice, groove or pitting corrosion, depending on the driving force, conductivity and relative anodic/cathodic areas ratio.

- c) Corrosion of the anode may be significantly higher immediately adjacent to the connection to the cathode, depending on solution conductivity ([Figure 4-70](#) and [Figure 4-71](#)).

#### **4.3.1.6 Prevention / Mitigation**

- a) The best method for prevention/mitigation is through good design.
- b) Differing alloys should not be in intimate contact in conductive environments unless the anode/cathode surface area ratio is favorable.
- c) Coatings can be helpful, but the more noble material should be coated.
- d) For piping, specially designed electric insulating bolt sleeves and gaskets can eliminate the electrical connection.
- e) Galvanic corrosion is the principle used in galvanized steel, where the Zn corrodes preferentially to protect the underlying carbon steel. (If there is a break in the galvanized coating, a large anode to small cathode area prevents accelerated corrosion of the steel). This anode-to-cathode relationship reverses at water temperatures over about 150°F (66°C).

#### **4.3.1.7 Inspection and Monitoring**

Visual inspection and UT thickness gauging are very effective methods for detecting galvanic corrosion. The damage may sometimes be hidden underneath a bolt or rivet head.

#### **4.3.1.8 Related Mechanisms**

Soil corrosion (see [4.3.9](#)).

#### **4.3.1.9 References**

1. "Corrosion Basics – An Introduction," NACE International, Houston, TX, 1984, pp. 33-37.

**Table 4-6 – Galvanic Series in Seawater. (Reference 1)**

Corroded End Anodic—More Active
Magnesium
Magnesium alloys
Zinc
Aluminum
Aluminum alloys
Steel
Cast iron
Type 410 SS (active state)
Ni-Resist
Type 304 SS (active state)
Type 316SS (active state)
Lead
Tin
Nickel
Brass
Copper
Bronze
Copper-Nickel
Monel
Nickel (passive state)
Type 410 SS (passive state)
Type 304 SS (passive state)
Type 316 SS (passive state)
Titanium
Graphite
Gold
Platinum
Protected End—Cathode - More Noble



Figure 4-70 – Preferential galvanic corrosion of the more active component of the two materials.

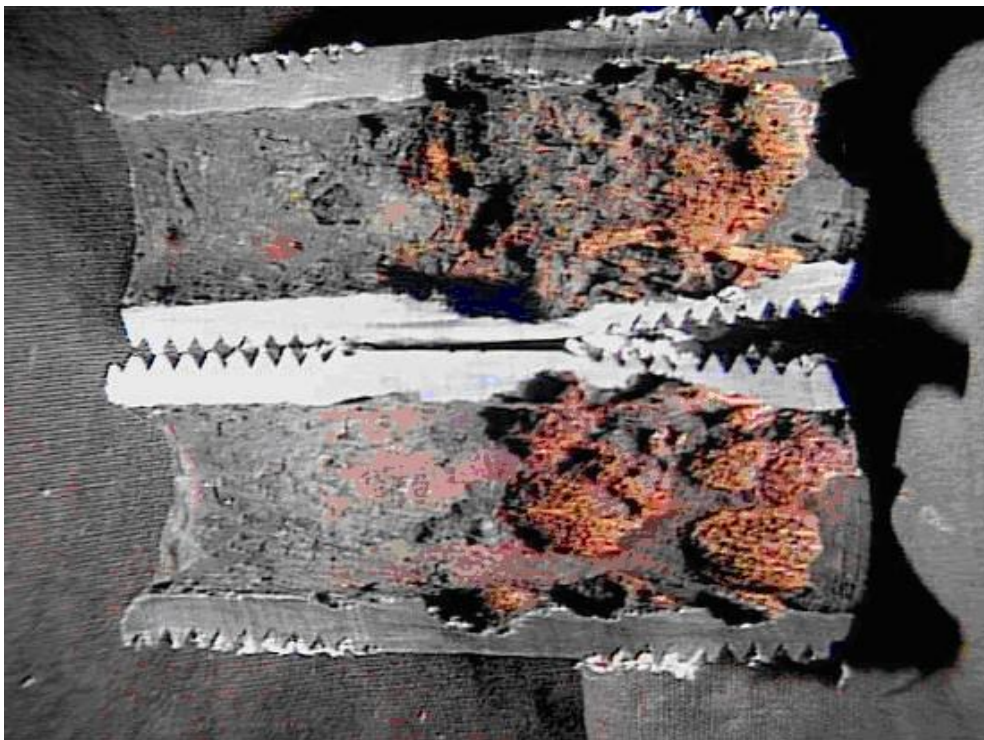


Figure 4-71 – Galvanic corrosion of a carbon steel nipple in a SS vessel in warm water service.



## 4.3.2 Atmospheric Corrosion

### 4.3.2.1 Description of Damage

A form of corrosion that occurs from moisture associated with atmospheric conditions. Marine environments and moist polluted industrial environments with airborne contaminants are most severe. Dry rural environments cause very little corrosion.

### 4.3.2.2 Affected Materials

Carbon steel, low alloy steels and copper alloyed aluminum.

### 4.3.2.3 Critical Factors

- a) Critical factors include the physical location (industrial, marine, rural); moisture (humidity), particularly designs that trap moisture or when present in a cooling tower mist; temperature; presence of salts, sulfur compounds and dirt.
- b) Marine environments can be very corrosive (20 mpy) as are industrial environments that contain acids or sulfur compounds that can form acids (5-10 mpy).
- c) Inland locations exposed to a moderate amount of precipitation or humidity are considered moderately corrosive environments (~1-3 mpy).
- d) Dry rural environments usually have very low corrosion rates (<1 mpy).
- e) Designs that trap water or moisture in crevices are more prone to attack.
- f) Corrosion rates increase with temperature up to about 250°F (121°C). Above 250°F (121°C), surfaces are usually too dry for corrosion to occur except under insulation (see 4.3.3).
- g) Chlorides, H<sub>2</sub>S, fly ash and other airborne contaminants from cooling tower drift, furnace stacks and other equipment accelerate corrosion.
- h) Bird turds can also cause accelerated corrosion and unsightly stains.

### 4.3.2.4 Affected Units or Equipment

- a) Piping and equipment with operating temperatures sufficiently low to allow moisture to be present.
- b) A paint or coating system in poor condition.
- c) Equipment may be susceptible if cycled between ambient and higher or lower operating temperatures.
- d) Equipment shut down or idled for prolonged periods unless properly mothballed.
- e) Tanks and piping are particularly susceptible. Piping that rests on pipe supports is very prone to attack due to water entrapment between the pipe and the support.
- f) Orientation to the prevailing wind and rain can also be a factor.
- g) Piers and docks are very prone to attack.
- h) Bimetallic connections such as copper to aluminum electrical connections

### 4.3.2.5 Appearance or Morphology of Damage

- a) The attack will be general or localized, depending upon whether or not the moisture is trapped.
- b) If there is no coating, corrosion or loss in thickness can be general.
- c) Localized coating failures will tend to promote corrosion.

- d) Metal loss may not be visually evident, although normally a distinctive iron oxide (red rust) scale forms as shown in [Figure 4-72](#).

#### **4.3.2.6    *Prevention / Mitigation***

Surface preparation and proper coating application are critical for long-term protection in corrosive environments.

#### **4.3.2.7    *Inspection and Monitoring***

VT and UT are techniques that can be used.

#### **4.3.2.8    *Related Mechanisms***

Corrosion under insulation (see [4.3.3](#)).

#### **4.3.2.9    *References***

1. ASM Metals Handbook, Volume 13, "Corrosion," ASM International, Materials Park, OH.



**Figure 4-72 – Atmospheric Corrosion of an LPG line in close proximity to a cooling tower.**

### 4.3.3 Corrosion Under Insulation (CUI)

#### 4.3.3.1 Description of Damage

Corrosion of piping, pressure vessels and structural components resulting from water trapped under insulation or fireproofing.

#### 4.3.3.2 Affected Materials

Carbon steel, low alloy steels, 300 Series SS, and duplex stainless steels.

#### 4.3.3.3 Critical Factors

- a) It affects externally insulated piping and equipment and those that are in intermittent service or operate between:
  - 1) 10°F (−12°C) and 350°F (175°C) for carbon and low alloy steels,
  - 2) 140°F (60°C) and 400°F (205°C) for austenitic stainless steels and duplex stainless steels
- b) Corrosion rates increase with increasing metal temperature up to the point where the water evaporates quickly. For insulated components, corrosion becomes more severe at metal temperatures between the boiling point 212°F (100°C) and 350°F (121°C), where water is less likely to vaporize and insulation stays wet longer.
- c) Design of insulation system, insulation type, temperature and environment are critical factors.
- d) Poor design and/or installations that allow water to become trapped will increase CUI.
- e) Insulating materials that hold moisture (wick) can be more of a problem.
- f) Cyclic thermal operation or intermittent service can increase corrosion.
- g) Equipment that operates below the water dewpoint tends to condense water on the metal surface thus providing a wet environment and increasing the risk of corrosion.
- h) Damage is aggravated by contaminants that may be leached out of the insulation, such as chlorides.
- i) Plants located in areas with high annual rainfall or warmer, marine locations are more prone to CUI than plants located in cooler, drier, mid-continent locations.
- j) Environments that provide airborne contaminants such as chlorides (marine environments, cooling tower drift) or SO<sub>2</sub> (stack emissions) can accelerate corrosion.

#### 4.3.3.4 Affected Units or Equipment

- a) All insulated piping and equipment are susceptible to CUI under conditions noted above even on piping and equipment where the insulation system appears to be in good condition and no visual signs of corrosion are present.
- b) Examples of locations where CUI can occur are listed below:
  - 1) CUI can be found on equipment with damaged insulation, vapor barriers, weatherproofing or mastic, or protrusions through the insulation or at insulation termination points such as flanges.
  - 2) Equipment designed with insulation support rings welded directly to the vessel wall (no standoff); particularly around ladder and platform clips, and lifting lugs, nozzles and stiffener rings.
  - 3) Piping or equipment with damaged/leaking steam tracing.
  - 4) Localized damage at paint and/or coating systems.
  - 5) Locations where moisture/water will naturally collect (gravity drainage) before evaporating (insulation support rings on vertical equipment) and improperly terminated fireproofing.

- 6) Vibrating piping systems that have a tendency to inflict damage to insulation jacketing providing a path for water ingress.
- 7) Deadlegs (vents, drains, and other similar items).
- 8) Pipe hangers and other supports.
- 9) Valves and fittings (irregular insulation surfaces).
- 10) Bolted-on pipe shoes.
- 11) Steam tracer tubing penetrations.
- 12) Termination of insulation at flanges and other piping components.
- 13) Insulation jacketing seams located on the top of horizontal piping or improperly lapped or sealed insulation jacketing.
- 14) Termination of insulation in a vertical pipe.
- 15) Caulking that has hardened, has separated, or is missing.
- 16) Bulges or staining of the insulation or jacketing system or missing bands. (Bulges may indicate corrosion product buildup.)
- 17) Low points in piping systems that have a known breach in the insulation system, including low points in long unsupported piping runs.
- 18) Carbon or low-alloy steel flanges, bolting, and other components under insulation in high-alloy piping systems.
- 19) Locations where insulation plugs have been removed to permit piping thickness measurements on insulated piping and equipment should receive particular attention. These plugs should be promptly replaced and sealed. Several types of removable plugs are commercially available that permit inspection and identification of inspection points for future reference.
- 20) The first few feet of a horizontal pipe run adjacent to the bottom of a vertical run.

#### **4.3.3.5 Appearance or Morphology of Damage**

- a) Carbon and low alloy steels are subject to localized pitting corrosion and or localized loss in thickness.
- b) 300 Series SS are also subject to Stress Corrosion Cracking (SCC) if chlorides are present, while the duplex SS are less susceptible.
- c) 300 Series SS and duplex SS are subject to pitting and localized corrosion. For 300 Series SS, specifically in older calcium silicate insulation (known to contain chlorides), localized pitting and chloride stress corrosion cracking can occur.
- d) After insulation is removed from carbon and low alloy steels, CUI damage often appears as loose, flaky scale covering the corroded component. Damage may be highly localized ([Figure 4-73 to 4-79](#)).
- e) In some localized cases, the corrosion can appear to be carbuncle type pitting (usually found under a failed paint/coating system).
- f) Tell tale signs of insulation and paint/coating damage often accompany CUI.

#### **4.3.3.6 Prevention / Mitigation**

- a) Since the majority of construction materials used in plants are susceptible to CUI degradation, mitigation is best achieved by using appropriate paints/coatings and maintaining the insulation/sealing/vapor barriers to prevent moisture ingress.

- b) Flame-sprayed aluminum coatings have been used on carbon steels. The coating corrodes preferentially by galvanic action, thereby protecting the base metal.
- c) High quality non-metallic coatings, properly applied to the surfaces to be insulated can provide long term protection.
- d) Thin aluminum foil wrapped on stainless steel piping and equipment has been used on stainless steels as an effective barrier under insulation.
- e) Careful selection of insulating materials is important. Closed-cell foam glass materials will hold less water against the vessel/pipe wall than mineral wool and potentially be less corrosive.
- f) Low chloride insulation should be used on 300 Series SS to minimize the potential for pitting and chloride SCC.
- g) It is not usually possible to modify operating conditions. However, consideration should be given to removing the insulation on equipment where heat conservation is not as important.

#### **4.3.3.7 Inspection and Monitoring**

- a) An inspection plan for corrosion under insulation should be a structured and systematic approach starting with prediction/analysis, then looking at the more invasive procedures. The inspection plan should consider operating temperature; type and age/condition of coating; and type and age/condition of insulation material. Additional prioritization can be added from a physical inspection of the equipment, looking for evidence of insulation, mastic and/or sealant damage, signs of water penetration and rust in gravity drain areas around the equipment.
- b) Although external insulation may appear to be in good condition, CUI damage may still be occurring. CUI inspection may require removal of some or all insulation. If external coverings are in good condition and there is no reason to suspect damage behind them, it may not be necessary to remove them for inspection of the vessel.
- c) Considerations for insulation removal are not limited to but include:
  - 1) History of CUI for the vessel or comparable equipment.
  - 2) Visual condition of the external covering and insulation.
  - 3) Evidence of fluid leakage, e.g. stains.
  - 4) Equipment in intermittent service.
  - 5) Condition/age of the external coating, if applicable.
- d) Common areas of concern in process units are high moisture areas such as those down-wind from cooling towers, near steam vents, deluge systems, acid vapors, or near supplemental cooling with water spray.
- e) When developing the inspection plan for CUI inspection, the inspector should consider
  - 1) Areas that are most susceptible to CUI. If CUI damage is found, the inspector should inspect other susceptible areas on the vessel.
  - 2) Utilize multiple inspection techniques to produce the most cost effective approach, including:
    - Partial and/or full stripping of insulation for visual examination.
    - UT for thickness verification.
    - Real-time profile x-ray (for small bore piping).
    - Neutron backscatter techniques for identifying wet insulation.
    - Deep penetrating eddy-current inspection (can be automated with a robotic crawler).

- IR thermography looking for wet insulation and/or damaged and missing insulation under the jacket.
- Guided wave UT.

#### **4.3.3.8 Related Mechanisms**

Atmospheric corrosion (see [4.3.2](#)), oxidation (see [4.4.1](#)) and chloride SCC (see [4.5.1](#)).

#### **4.3.3.9 References**

1. API RP 581, Risk-Based Inspection Technology, American Petroleum Institute, Washington, D.C., 2008.
2. NACE Standard RP0198, The Control of Corrosion Under Thermal Insulation, and Fireproofing – A Systems Approach, NACE International, Houston, TX.
3. W.I. Pollock and C.N. Steely, “Corrosion Under Wet Thermal Insulation,” NACE International, Houston, TX, 1990.
4. M. M. Chauviere, et al., “Managing CUI in aging refinery pressure vessels”, Paper #07566, NACE International, Houston, TX.
5. API 510, “Pressure Vessel Inspection Code: Maintenance Inspection, Rating, Repair, and Alteration”, American Petroleum Institute, Washington, D.C.
6. API 570, Piping Inspection Code, American Petroleum Institute, Washington, D.C.



**Figure 4-73 – Tee in a 1000 psig ethylene line before insulation removal.**



**Figure 4-74 – Close-up of Tee CUI of a Tee in Figure 4-73 after insulation removal.**





Figure 4-75 – CUI of a 30 inch CS Butadiene line showing highly localized corrosion which could only be found by stripping the entire line. Note the 0.25 in (6.5 mm) diameter hole at arrow.



Figure 4-76 – CUI of nozzle on a bottom head.



Figure 4-77 – CUI of nozzle on a top head.

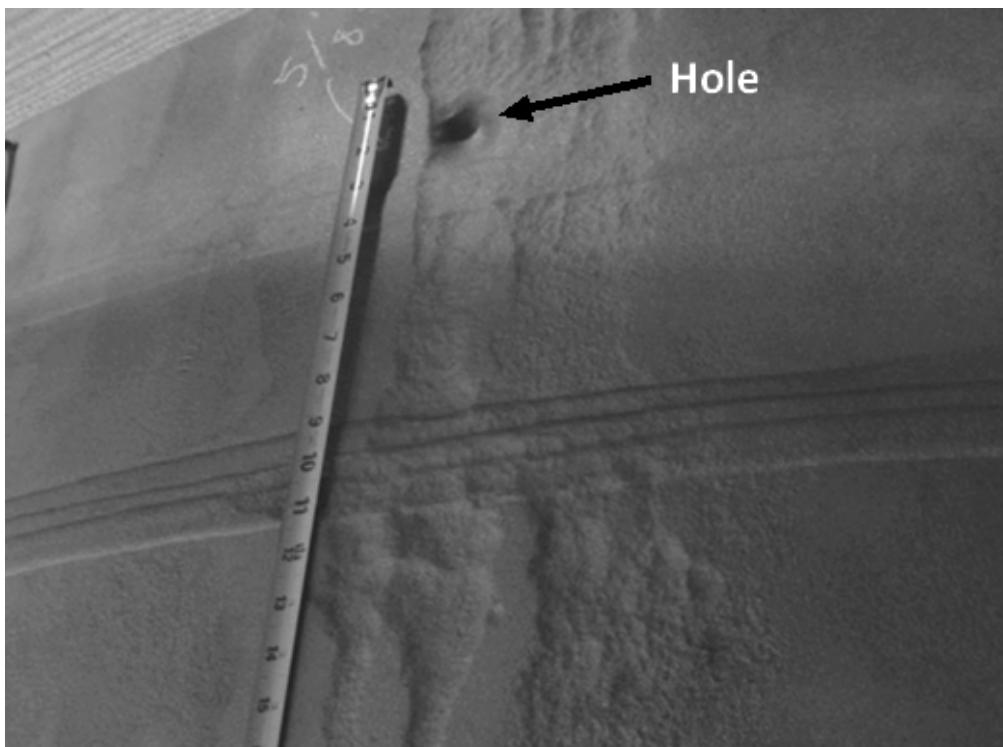
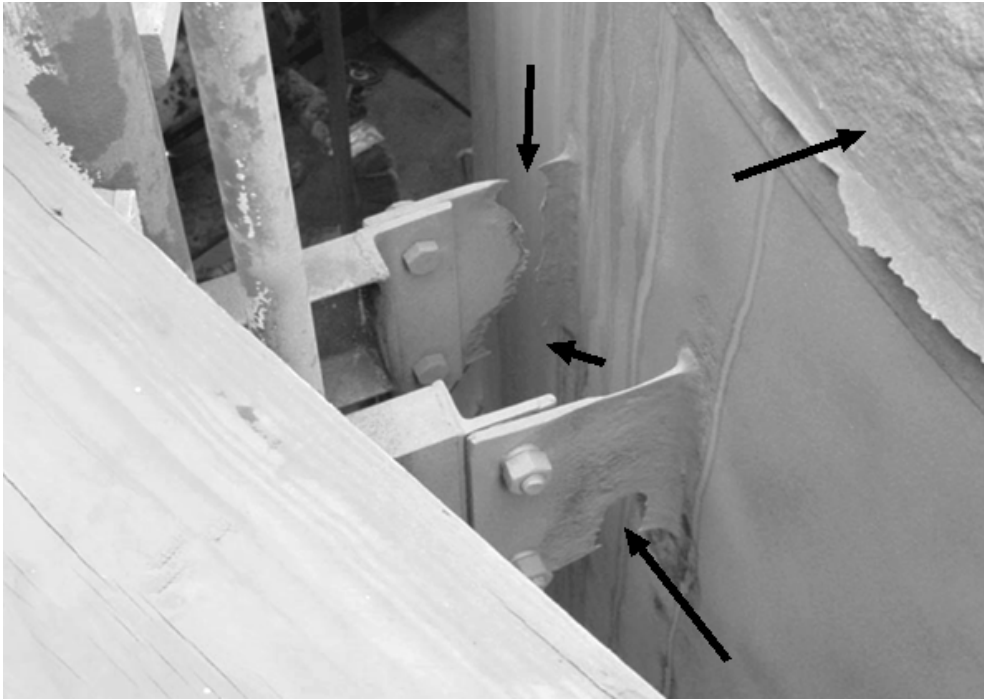


Figure 4-78 – CUI of vessel wall. Note leak at arrow.



**Figure 4-79 – CUI at attachment supports and vessel head.**



**Figure 4-80 – CUI of CS level bridge.**

#### 4.3.4 Cooling Water Corrosion

##### 4.3.4.1 Description of Damage

General or localized corrosion of carbon steels and other metals caused by dissolved salts, gases, organic compounds or microbiological activity.

##### 4.3.4.2 Affected Materials

Carbon steel, all grades of stainless steel, copper, aluminum, titanium and nickel base alloys.

##### 4.3.4.3 Critical Factors

- a) Cooling water corrosion and fouling are closely related and should be considered together. Fluid temperature, type of water (fresh, brackish, salt water) and the type of cooling system (once-through, open circulating, closed circulating), oxygen content, and fluid velocities are critical factors.
- b) Increasing cooling water outlet temperatures and or process side inlet temperatures tend to increase corrosion rates as well as fouling tendency.
- c) Increasing oxygen content tends to increase carbon steel corrosion rates.
- d) If the process side temperature is above 140°F (60°C), a scaling potential exists with fresh water and becomes more likely as process temperatures increase and as cooling water inlet temperatures rise. Brackish and salt water outlet temperatures above about 115°F (46°C) may cause serious scaling.
- e) Fouling may occur from mineral deposits (hardness), silt, suspended organic materials, corrosion products, mill scale, marine and microbiological growth.
- f) Velocities should be high enough to minimize fouling and drop out of deposits but not so high as to cause erosion. Velocity limits depend on the tube material and water quality.
- g) Low velocities can promote increased corrosion. Velocities below about 3 fps (1 m/s) are likely to result in fouling, sedimentation and increased corrosion in fresh and brackish water systems. Accelerated corrosion can also result from dead spots or stagnant areas if cooling water is used on the shell side of condensers/coolers rather than the preferred tube side.
- h) 300 Series SS can suffer pitting corrosion, crevice corrosion and SCC in fresh, brackish and salt water systems.
- i) Copper/zinc alloys can suffer dezincification in fresh, brackish and salt water systems. The copper/zinc alloys can suffer SCC if any ammonia or ammonium compounds are present in the water or on the process side.
- j) ERW carbon steel may suffer severe weld and/or heated affected zone corrosion in fresh and/or brackish water.
- k) When connected to a more anodic material, titanium may suffer severe hydriding embrittlement. Generally, the problem occurs at temperatures above 180°F (82°C) but can occur at lower temperatures.

##### 4.3.4.4 Affected Units or Equipment

Cooling water corrosion is a concern with water-cooled heat exchangers and cooling towers in all applications across all industries.

##### 4.3.4.5 Appearance or Morphology of Damage

- a) Cooling water corrosion can result in many different forms of damage including general corrosion, pitting corrosion ([Figure 4-81](#)), MIC, stress corrosion cracking and fouling.
- b) General or uniform corrosion of carbon steel occurs when dissolved oxygen is present.

- c) Localized corrosion may result from underdeposit corrosion, crevice corrosion or microbiological corrosion.
- d) Deposits or crevices can lead to underdeposit or crevice corrosion of any of the affected materials.
- e) Wavy or smooth corrosion at nozzle inlets/outlets and tube inlets may be due to flow induced corrosion, erosion or abrasion.
- f) Corrosion at ERW weld areas will appear as grooving along the weld fusion lines.
- g) Metallurgical analysis of tube samples may be required to confirm the mode of failure.

#### **4.3.4.6      *Prevention / Mitigation***

- a) Cooling water corrosion (and fouling) can be prevented by proper design, operation and chemical treatment of cooling water systems.
- b) Design for process side inlet temperatures below 140°F (60°C).
- c) Minimum and maximum water velocities must be maintained, particularly in salt water systems.
- d) The metallurgy of heat exchanger components may need to be upgraded for improved resistance, especially in waters with high chloride content, low velocity, high process temperatures, and/or poorly maintained water chemistry.
- e) Periodic mechanical cleaning of tube ID's and OD's should be performed in order to maintain clean heat transfer surfaces.
- f) With very few exceptions, cooling water should be on the tube side to minimize stagnant areas.

#### **4.3.4.7      *Inspection and Monitoring***

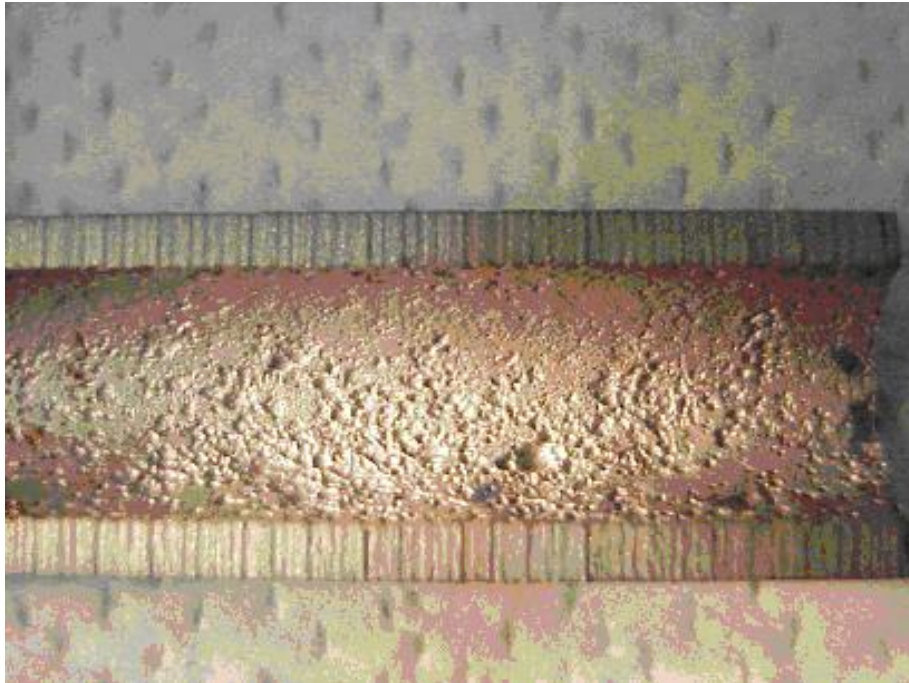
- a) Cooling water should be monitored for variables that affect corrosion and fouling including, pH, oxygen content, cycles of concentration, biocide residual, biological activity, cooling water outlet temperatures, hydrocarbon contamination and process leaks.
- b) Periodic calculation of U-factors (heat exchanger performance measurement) will provide information on scaling and fouling.
- c) Ultrasonic flow meters can be used to check the velocity of water in the tubes.
- d) EC or IRIS inspection of tubes.
- e) Splitting representative tubes.

#### **4.3.4.8      *Related Mechanisms***

Microbiologically induced corrosion (see 4.3.8), chloride stress corrosion cracking (see 4.5.1) and galvanic corrosion (see 4.3.1).

#### **4.3.4.9      *References***

1. T.J. Tvedt, Jr., "Cooling Water Systems," NACE Course Book on Corrosion Control in the Refining Industry, NACE International, Houston, TX, 1999.
2. H.M. Herro and R.D. Port, "NALCO Guide to Cooling Water System Failure Analysis," McGraw-Hill, Inc., NY, 1991, pp. 259-263.



**Figure 4-81 – Cooling water corrosion on the I.D. of a CS heat exchanger tube operating at 86°F (30°C).**

### **4.3.5 Boiler Water Condensate Corrosion**

#### **4.3.5.1 Description of Damage**

General corrosion and pitting in the boiler system and condensate return piping.

#### **4.3.5.2 Affected Materials**

Primarily carbon steel, some low alloy steel, some 300 Series SS and copper based alloys.

#### **4.3.5.3 Critical Factors**

- a) Corrosion in boiler feedwater and condensate return systems is usually the result of dissolved gases, oxygen and carbon dioxide, which lead to oxygen pitting corrosion and carbonic acid corrosion, respectively.
- b) Critical factors are the concentration of dissolved gas (oxygen and or carbon dioxide), pH, temperature, quality of the feedwater, and the specific feedwater treating system.
- c) Corrosion protection in the boiler is accomplished by laying down and continuously maintaining a layer of protective  $\text{Fe}_3\text{O}_4$  (magnetite).
- d) The chemical treatment for scale and deposit control must be adjusted to coordinate with the oxygen scavenger for the specific water service and boiler feedwater treating system.
- e) Ammonia SCC of Cu-Zn alloys can occur due to hydrazine, neutralizing amines or ammonia-containing compounds.

#### **4.3.5.4 Affected Units or Equipment**

Corrosion can occur in the external treatment system, deaerating equipment, feedwater lines, pumps, stage heaters and economizers as well as the steam generation system on both the water and fire sides and the condensate return system.

#### **4.3.5.5 Appearance or Morphology of Damage**

- a) Corrosion from oxygen tends to be a pitting type damage and can show up anywhere in the system even if only very small quantities break through the scavenging treatment. Oxygen is particularly aggressive in equipment such as closed heaters and economizers where there is a rapid water temperature rise ([Figure 4-82](#)).
- b) Corrosion in the condensate return system tends to be due to carbon dioxide although some oxygen pitting problems can occur if the oxygen scavenging treatment is not working correctly. Carbon dioxide corrosion tends to be a smooth grooving of the pipe wall ([Figures 4-83](#) and [4-84](#)).

#### **4.3.5.6 Prevention/Mitigation**

- a) Oxygen scavenging treatments typically include catalyzed sodium sulfite or hydrazine depending on the system pressure level along with proper mechanical deaerator operation. A residual of the oxygen scavenger is carried into the steam generation system to handle any oxygen ingress past the deaerator.
- b) If the scale/deposit control/magnetite maintenance treatment scheme does not minimize carbon dioxide in the condensate return system, an amine inhibitor treatment might be required.

#### **4.3.5.7 Inspection and Monitoring**

- a) Water analysis is the common monitoring tool used to assure that the various treatment systems are performing in a satisfactory manner. Parameters which can be monitored for signs of upset include the pH, conductivity, chlorine or residual biocide, and total dissolved solids to check for leaks in the form of organic compounds.



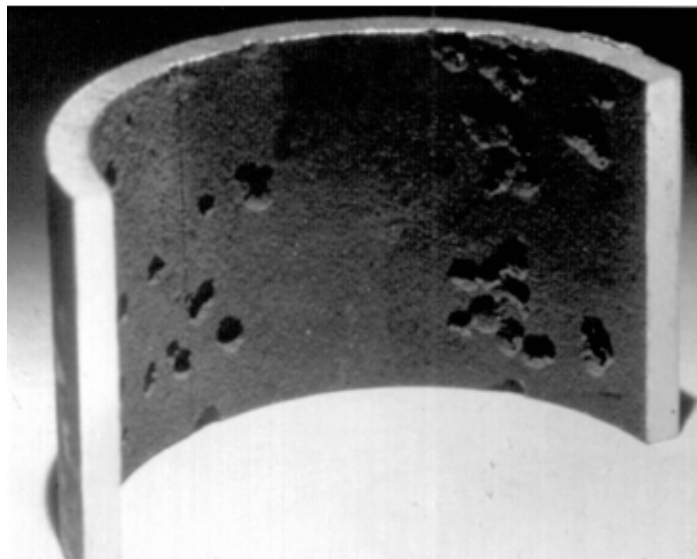
- 
- b) There are no proactive inspection methods other than developing an appropriate program when problems such as a ruptured boiler tube or condensate leaks are recognized in the various parts of complex boiler water and condensate systems.
  - c) Deaerator cracking problems can be evaluated off-line at shutdowns by utilizing properly applied wet fluorescence magnetic particle inspection.

#### **4.3.5.8     *Related Mechanisms***

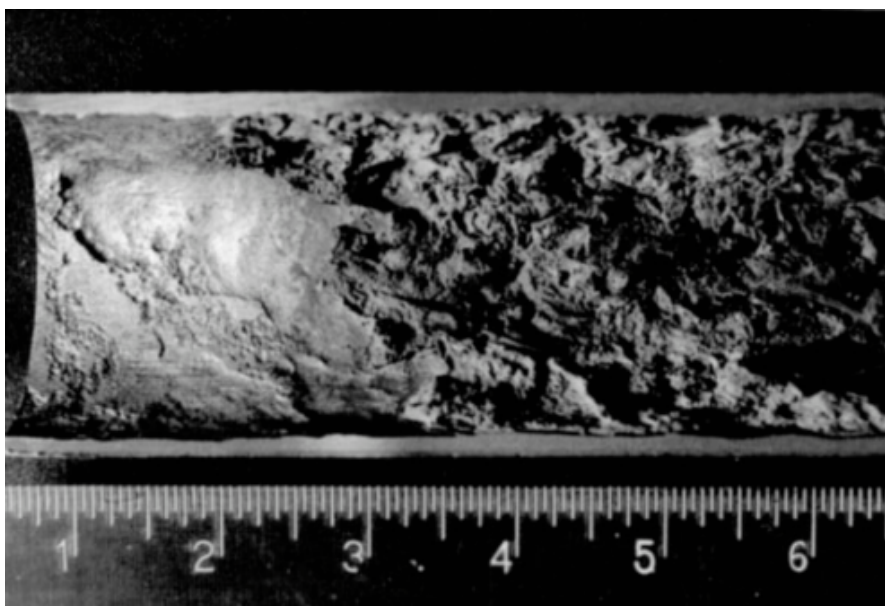
CO<sub>2</sub> corrosion (see 4.3.6), corrosion fatigue (see 4.5.2), and erosion/erosion-corrosion (see 4.2.14).

#### **4.3.5.9     *References***

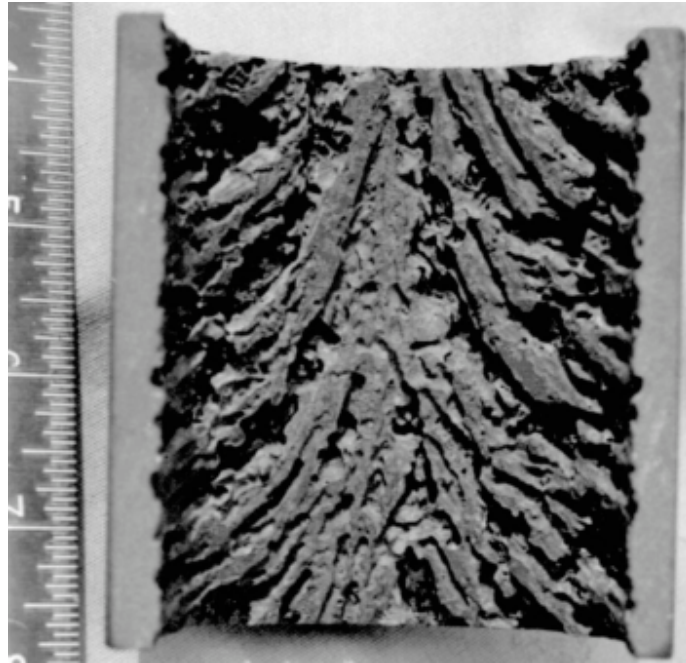
1. "Betz Handbook of Industrial Water Conditioning," Eighth Edition, Betz Laboratories, Inc., PA, 1980.
2. R.D. Port and H.M. Herro, "The Nalco Guide to Boiler Failure Analysis," McGraw-Hill, Inc., NY, 1991.
3. NACE SP0590-2007, "Prevention, Detection, and Correction of Deaerator Cracking", NACE International, Houston, TX.
4. T-Y Cnen et al., "Condensate corrosion in steam generating systems, Paper # 718, NACE International, Houston, TX, 1998.



**Figure 4-82 – Pits caused by oxygen corrosion.**



**Figure 4-83 – General metal loss (left end of tube) on steel resulting from oxygen corrosion. The color of hydrous ferric oxide is orange to red brown.**



**Figure 4-84 – Jagged fir-tree pattern of corrosion inside a tilted steel pipe caused by condensing steam containing high concentrations of carbon dioxide.**

### 4.3.6 CO<sub>2</sub> Corrosion

#### 4.3.6.1 *Description of Damage*

Carbon dioxide (CO<sub>2</sub>) corrosion results when CO<sub>2</sub> dissolves in water to form carbonic acid (H<sub>2</sub>CO<sub>3</sub>). The acid may lower the pH and sufficient quantities may promote general corrosion and/or pitting corrosion of carbon steel.

#### 4.3.6.2 *Affected Materials*

Carbon steel and low alloy steels.

#### 4.3.6.3 *Critical Factors*

- a) The partial pressure of CO<sub>2</sub>, pH and temperature are critical factors.
- b) Increasing partial pressures of CO<sub>2</sub> result in lower pH condensate and higher rates of corrosion.
- c) Corrosion occurs in the liquid phase, often at locations where CO<sub>2</sub> condenses from the vapor phase.
- d) Increasing temperatures increase corrosion rate up to the point where CO<sub>2</sub> is vaporized.
- e) Increasing the level of chromium in steels offers no major improvement in resistance until a minimum of 12% is reached.

#### 4.3.6.4 *Affected Units or Equipment*

- a) Boiler feedwater and condensate systems in all units are affected.
- b) Effluent gas streams of the shift converters in hydrogen plants can be affected. Corrosion usually occurs when the effluent stream drops below the dew point, approximately 300°F (149°C). Corrosion rates as high as 1000 mpy have been observed.
- c) Overhead systems of regenerators in CO<sub>2</sub> removal plants are affected.

#### 4.3.6.5 *Appearance or Morphology of Damage*

- a) Localized thinning and/or pitting corrosion of carbon steel ([Figure 4-85](#), [Figure 4-86](#) and [Figure 4-87](#)).
- b) Carbon steel may suffer deep pitting and grooving in areas of turbulence ([Figure 4-88](#)).
- c) Corrosion generally occurs in areas of turbulence and impingement and sometimes at the root of piping welds.

#### 4.3.6.6 *Prevention / Mitigation*

- a) Corrosion inhibitors can reduce corrosion in steam condensate systems. Vapor phase inhibitors may be required to protect against condensing vapors.
- b) Increasing condensate pH above 6 can reduce corrosion in steam condensate systems.
- c) The 300 Series SS are highly resistant to corrosion in most applications. Selective upgrading to stainless steels is usually required in operating units designed to produce and/or remove CO<sub>2</sub> (such as hydrogen plants and CO<sub>2</sub> removal units).
- d) Steam condensate systems that experience CO<sub>2</sub> corrosion are usually the result of operating problems.
- e) 400 Series SS and duplex SS are also resistant.

#### 4.3.6.7 *Inspection and Monitoring*

- a) VT, UT and RT inspection techniques should focus on general and local loss in thickness where water wetting is anticipated.

- b) Preferential corrosion of weld seams may require angle probe UT or RT.
- c) Corrosion may occur along the bottom surface of the pipe if there is a separate water phase, at the top surface of the pipe if condensation in wet gas systems is anticipated, and in the turbulent flow areas at elbow and tees.
- d) Monitor water analyses (pH, Fe, etc.) to determine changes in operating conditions.

#### **4.3.6.8     *Related Mechanisms***

Boiler water condensate corrosion (see [4.3.5](#)) and carbonate cracking (see [5.1.2.5](#)).

#### **4.3.6.9     *References***

1. "NACE Course Book on Corrosion Control in the Refining Industry," NACE International, Houston, TX, 1999.
2. L. Garverick, "Corrosion in the Petrochemical Industry," ASM International, Materials Park, OH, 1994.
3. H.M. Herro and R.D. Port, "NALCO Guide to Cooling Water System Failure Analysis," McGraw-Hill, Inc., NY, 1991, pp. 259-263.



Figure 4-85 – CO<sub>2</sub> corrosion of a carbon steel oil and gas production flow line.

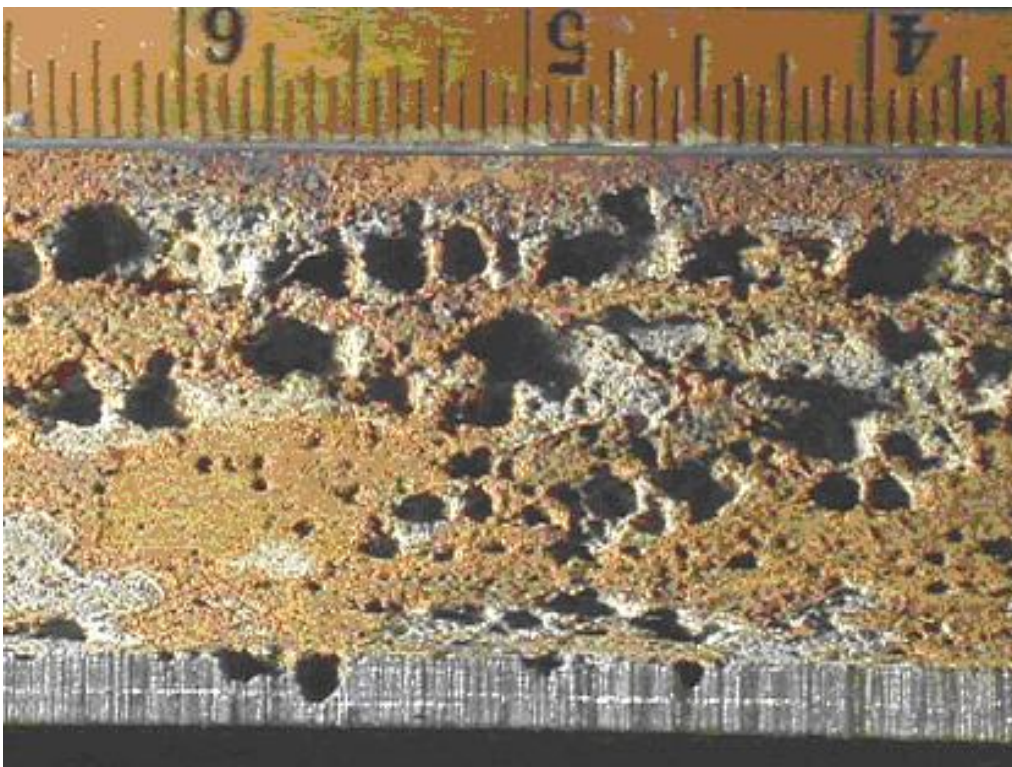


Figure 4-86 – Higher magnification view of the corrosion pits in Figure 4-85.



Figure 4-87 – CO<sub>2</sub> corrosion of CS pipe nipple in CO<sub>2</sub> contaminated water.

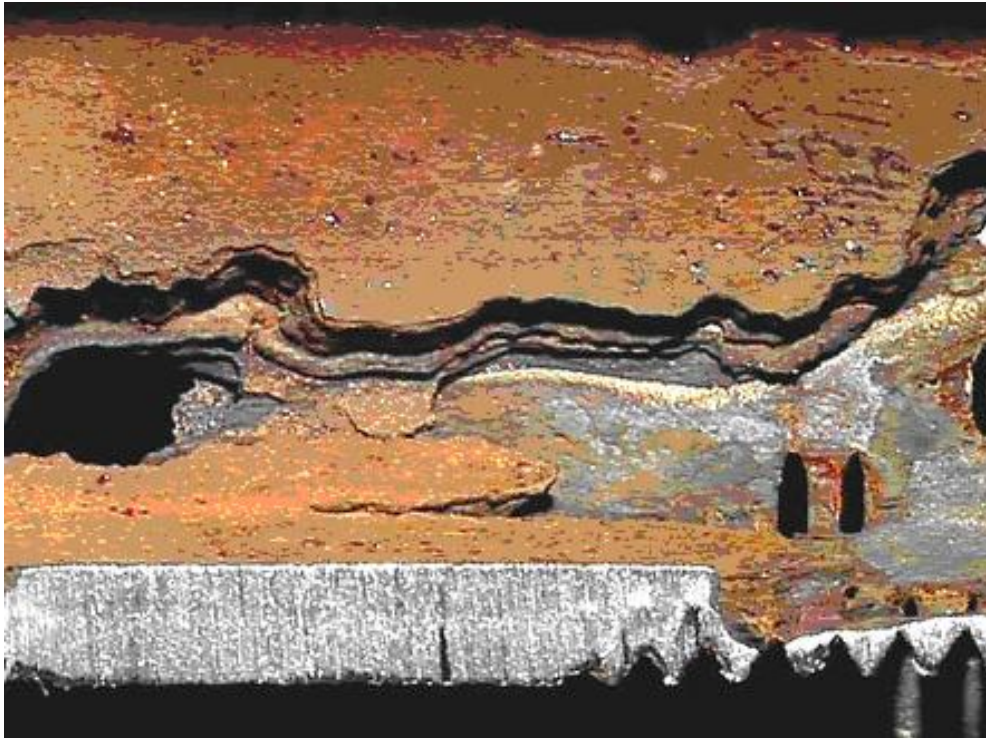


Figure 4-88 – A view inside the nipple in Figure 4-87 showing “Mesa” type corrosion typical of CO<sub>2</sub> corrosion.

### **4.3.7 Flue-Gas Dew-Point Corrosion**

#### **4.3.7.1 Description of Damage**

- a) Sulfur and chlorine species in fuel will form sulfur dioxide, sulfur trioxide and hydrogen chloride within the combustion products.
- b) At low enough temperatures, these gases and the water vapor in the flue gas will condense to form sulfurous acid, sulfuric acid and hydrochloric acid which can lead to severe corrosion.

#### **4.3.7.2 Affected Materials**

Carbon steel, low alloy steels and 300 Series SS.

#### **4.3.7.3 Critical Factors**

- a) The concentration of contaminants (sulfur and chlorides) in the fuel and the operating temperature of flue gas metal surfaces determine the likelihood and severity of corrosion.
- b) Since all fuels contain some amount of sulfur, sulfuric and sulfurous acid dewpoint corrosion can occur if the metal temperatures are below the dewpoint.
- c) The dewpoint of sulfuric acid depends on the concentration of sulfur trioxide in the flue gas, but is typically about 280°F (138°C).
- d) Similarly, the dewpoint of hydrochloric acid depends on the concentration of hydrogen chloride. It is typically about 130°F (54°C).

#### **4.3.7.4 Affected Units or Equipment**

- a) All fired process heaters and boilers that burn fuels containing sulfur have the potential for sulfuric acid dewpoint corrosion in the economizer sections and in the stacks.
- b) Heat-Recovery Steam Generators (HRSG's) that have 300 Series SS feedwater heaters may suffer chloride-induced stress corrosion cracking from the gas side (OD) when the temperature of the inlet water is below the dewpoint of hydrochloric acid.
- c) 300 Series SS feedwater heaters in HRSG's are potentially at risk if the atmosphere of the combustion turbine includes chlorine. Cooling tower drift from cooling towers that use chlorine-based biocides may blow into the combustion turbine and lead to potential damage in the feedwater heaters.

#### **4.3.7.5 Appearance or Morphology of Damage**

- a) Sulfuric acid corrosion on economizers or other carbon steel or low alloy steel components will have general wastage often with broad, shallow pits, depending on the way the sulfuric acid condenses.
- b) For the 300 Series SS feedwater heaters in HRSG's, stress corrosion cracking will have surface breaking cracks and the general appearance will be somewhat crazed.

#### **4.3.7.6 Prevention / Mitigation**

- a) Maintain the metallic surfaces at the back end of the boilers and fired heaters above the temperature of sulfuric acid dewpoint corrosion.
- b) For HRSG's, avoid the use of 300 Series SS in the feedwater heaters if the environment is likely to contain chlorides.
- c) Similar damage occurs in oil-fired boilers when the units are water-washed to remove ash if the final rinse does not neutralize the acid salts. Sodium carbonate should be added to the final rinse as a basic solution to neutralize the acidic ash constituents.



**4.3.7.7 Inspection and Monitoring**

- a) Wall-thickness measurements by UT methods will monitor the wastage in economizer tubes.
- b) Stress corrosion cracking of 300 Series SS can be found using VT and PT inspection.

**4.3.7.8 Related Mechanisms**

At lower temperatures, hydrochloric acid may condense and promote HCL corrosion of carbon steels (see [5.1.1.4](#)) and chloride stress corrosion cracking of 300 Series SS (see [4.5.1](#)).

**4.3.7.9 References**

1. "Steam - Its Generation and Use," 40th Edition, Babcock and Wilcox, 1992.
2. "Combustion Fossil Power Systems," Third Edition, Combustion Engineering, CT, 1981.
3. H. Thielsch, "Defects And Failures in Pressure Vessels and Piping," Krieger Publishing Co., NY, 1977.
4. R.D. Port and H.M. Herro, "The NALCO Guide to Boiler Failure Analysis," McGraw Hill, NY, 1991.
5. D.N. French, "Metallurgical Failures in Fossil Fired Boilers," John Wiley and Sons, Publishers, Inc., NY, 1993.
6. B. Dooley and W. McNaughton, "Boiler Tube Failures: Theory and Practice," EPRI, CA, 1995.

### **4.3.8 Microbiologically Induced Corrosion (MIC)**

#### **4.3.8.1 Description of Damage**

A form of corrosion caused by living organisms such as bacteria, algae or fungi. It is often associated with the presence of tubercles or slimy organic substances.

#### **4.3.8.2 Affected Materials**

Most common materials of construction including carbon and low alloy steels, 300 Series SS and 400 Series SS, aluminum, copper and some nickel base alloys.

#### **4.3.8.3 Critical Factors**

- a) MIC is usually found in aqueous environments or services where water is always or sometimes present, especially where stagnant or low-flow conditions allow and/or promote the growth of microorganisms.
- b) Because there are several types, organisms can survive and grow under severe conditions including lack of oxygen, light or dark, high salinity, pH range of 0 to 12, and temperatures from 0°F to 235°F (-17°C to 113°C).
- c) Systems may become “inoculated” by the introduction of organisms that multiply and spread unless controlled.
- d) Different organisms thrive on different nutrients including inorganic substances (e.g., sulfur, ammonia, H<sub>2</sub>S) and organic substances (e.g., hydrocarbons, organic acids). In addition, all organisms require a source of carbon, nitrogen and phosphorous for growth.
- e) In-leakage of process contaminants such as hydrocarbons or H<sub>2</sub>S may lead to a massive increase in biofouling and corrosion.

#### **4.3.8.4 Affected Units or Equipment**

- a) MIC is most often found in heat exchangers, bottom water of storage tanks, piping with stagnant or low flow, and piping in contact with some soils.
- b) MIC is also found in equipment where the hydrotest water has not been removed or equipment has been left outside and unprotected.
- c) Product storage tanks and water cooled heat exchangers in any unit where cooling water is not properly treated can be affected.
- d) Fire water systems can be affected.

#### **4.3.8.5 Appearance or Morphology of Damage**

- a) MIC corrosion is usually observed as localized pitting under deposits or tubercles that shield the organisms.
- b) Damage is often characterized by cup-shaped pits within pits in carbon steel or subsurface cavities in stainless steel ([Figure 4-89](#) through [Figure 4-95](#)).

#### **4.3.8.6 Prevention / Mitigation**

- a) Microbes require water to thrive. Systems that contain water (cooling water, storage tanks, etc.) should be treated with biocides such as chlorine, bromine, ozone, ultraviolet light or proprietary compounds.
- b) Proper application of biocides will control but not eliminate microbes so that continued treatment is necessary.

- c) Maintain flow velocities above minimum levels. Minimize low flow or stagnant zones.
- d) Systems that are not designed or intended for water containment should be kept clean and dry.
- e) Empty hydrotest water as soon as possible. Blow dry and prevent moisture intrusion.
- f) Wrapping and cathodically protecting underground structures have been effective in preventing MIC.
- g) Effective mitigation of established organisms requires complete removal of deposits and organisms using a combination of pigging, blasting, chemical cleaning and biocide treatment.
- h) Add biocides to water phase in storage tanks.
- i) Maintain coatings on the interior of storage tanks.

#### **4.3.8.7     *Inspection and Monitoring***

- a) In cooling water systems, effectiveness of treatment is monitored by measuring biocide residual, microbe counts and visual appearance.
- b) Special probes have been designed to monitor for evidence of fouling which may precede or coincide with MIC damage.
- c) An increase in the loss of duty of a heat exchanger may be indicative of fouling and potential MIC damage.
- d) Foul smelling water may be a sign of trouble.

#### **4.3.8.8     *Related Mechanisms***

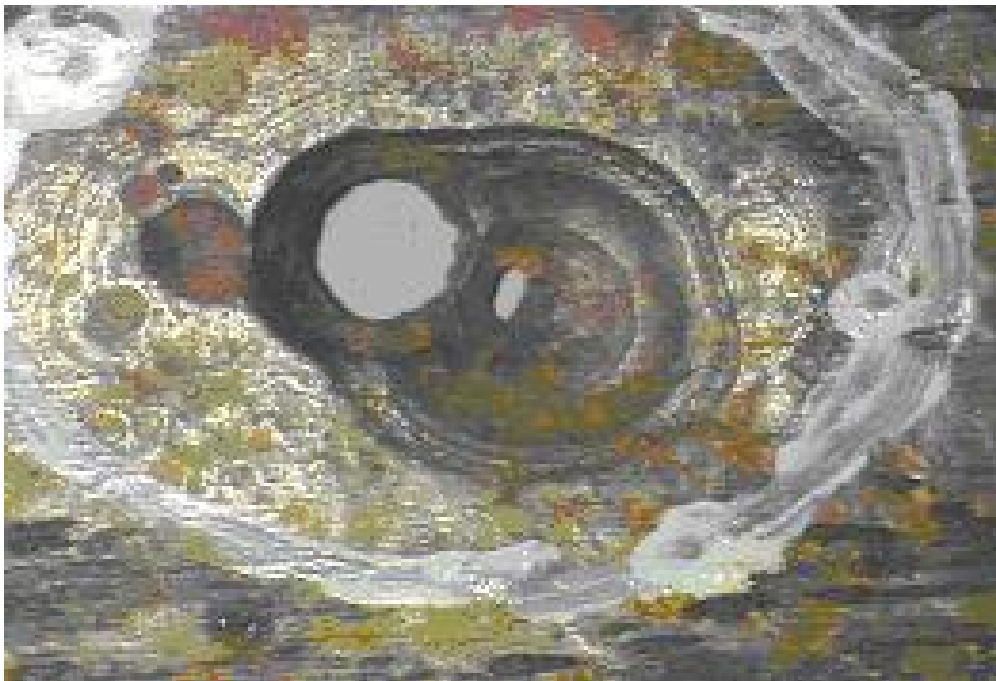
Cooling water corrosion (see [4.3.4](#)).

#### **4.3.8.9     *References***

1. D.H. Pope and J.G. Stoecker, "Process Industries Corrosion - The Theory and Practice," NACE International, Houston, TX, 1986, pp 227-235.
2. T.J. Tvedt, Jr., "Cooling Water Systems," NACE Course Book on Corrosion Control in the Refining Industry, NACE International, Houston, TX, 1999.
3. S.C. Dexter, "Biologically Induced Corrosion," NACE Proceedings of the International Conference on Biologically Induced Corrosion, June 10 -12, 1985, NACE International, Houston, TX, 1986.



**Figure 4-89 – MIC of diesel tank bottom.**



**Figure 4-90 – Pitting corrosion on the I.D. of a 6-inch CS sour crude line after 2.5 years of service. Pits are approximately 1-inch to 2-inch wide. Note the halo effect in Figure 4-91.**

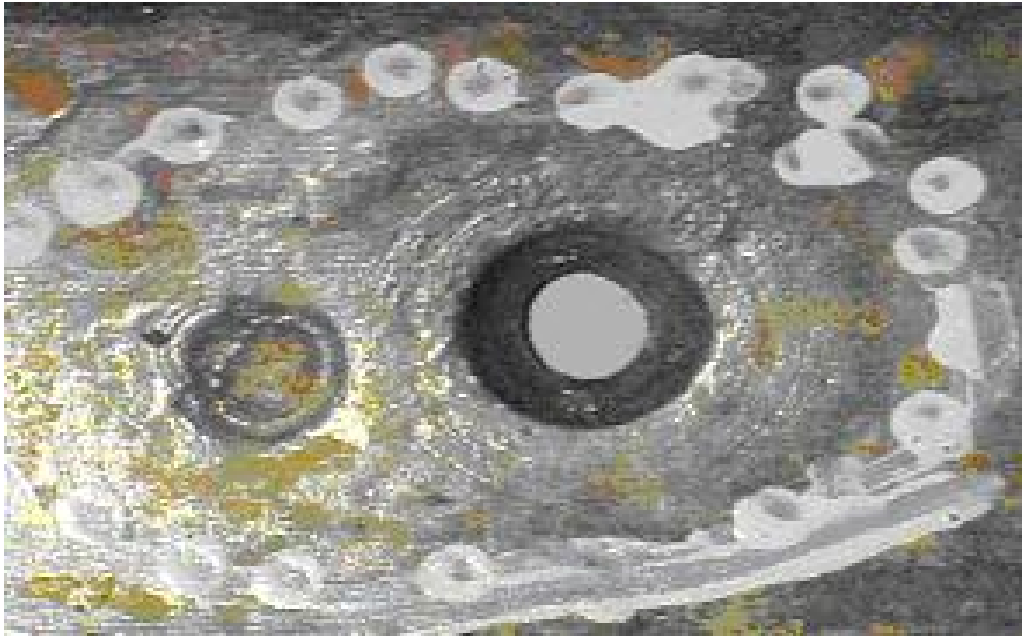


Figure 4-91 – Same pipe as Figure 4-90. Note the halo effect.

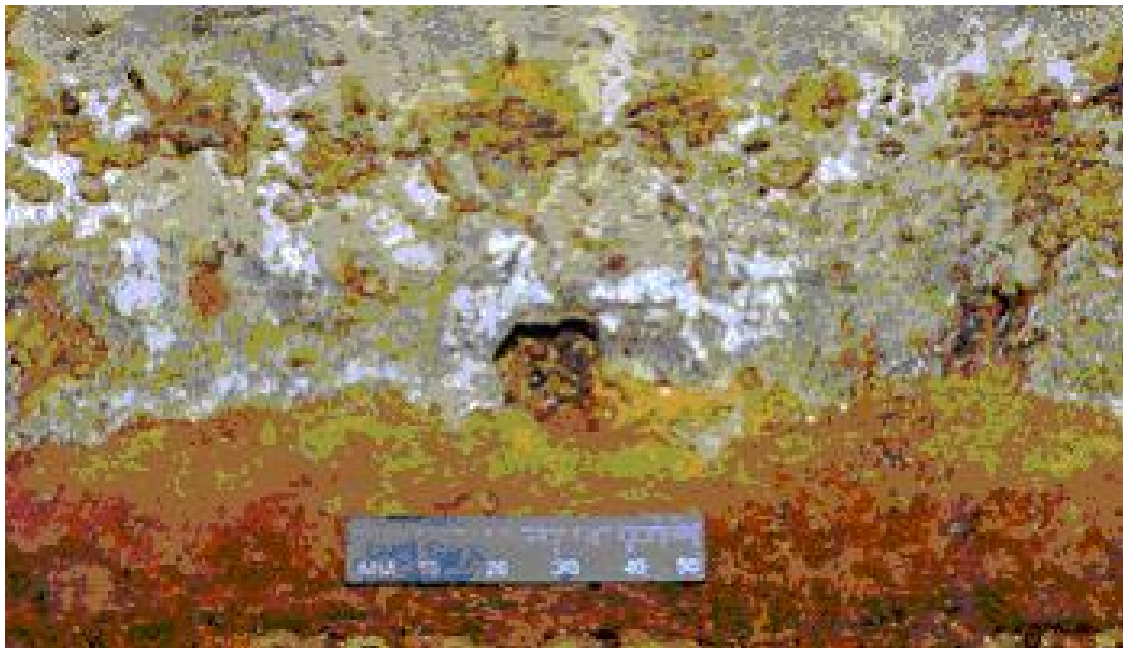
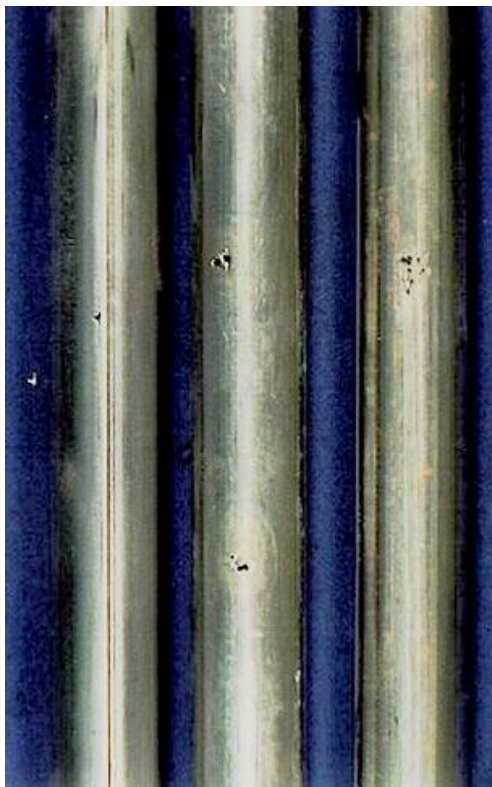


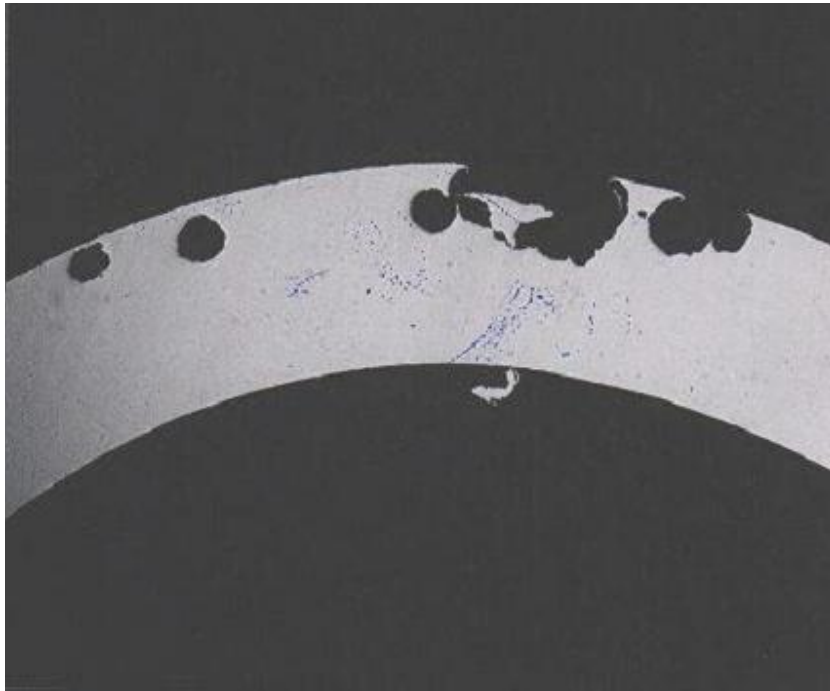
Figure 4-92 – Oil line with MIC damage beneath tubercles.



**Figure 4-93 – Same oil line as Figure 4-92. Hemispherical pitting typical of MIC can be seen after grit blasting to remove the scale.**



**Figure 4-94 – Type 304 stainless steel exchanger tubes failed from pitting corrosion on the shell side in cooling water service after 2.5 years without biocide treatment.**



**Figure 4-95 – A cross section of the tube (Figure 4-94) revealing severe subsurface tunneling, typical of MIC.**

### **4.3.9 Soil Corrosion**

#### **4.3.9.1 Description of Damage**

The deterioration of metals exposed to soils is referred to as soil corrosion.

#### **4.3.9.2 Affected Materials**

Carbon steel, cast iron and ductile iron.

#### **4.3.9.3 Critical Factors**

- a) The severity of soil corrosion is determined by many factors including operating temperature, moisture and oxygen availability, soil resistivity (soil condition and characteristics), soil type (water drainage), and homogeneity (variation in soil type), cathodic protection, stray current drainage, coating type, age, and condition.
- b) There is no single parameter that can be used to determine soil corrosivity. Instead, a number of characteristics must be combined to estimate the corrosion in particular soil as outlined in ASTM STP 741 as well as API RP 580 and API RPI 581.
- c) Soil resistivity is frequently used to estimate soil corrosivity, mainly because it is easy to measure. Soil resistivity is related to soil moisture content and dissolved electrolytes in the soil water.
- d) Soils having high moisture content, high dissolved salt concentrations, and high acidity are usually the most corrosive.
- e) Soil-to-air interface areas are often much more susceptible to corrosion than the rest of the structure because of moisture and oxygen availability ([Figure 4-96](#)).
- f) Corrosion rates increase with increasing metal temperature.
- g) Other factors that affect soil corrosion include galvanic corrosion, dissimilar soils, stray currents, differential aeration corrosion cells, and microbiologically induced corrosion.

#### **4.3.9.4 Affected Units or Equipment**

- a) Underground piping and equipment as well as buried tanks and the bottoms of above ground storage tanks ([Figure 4-97](#)).
- b) Ground supported metal structures ([Figure 4-98](#)).

#### **4.3.9.5 Appearance or Morphology of Damage**

- a) Soil corrosion appears as external thinning with localized losses due to pitting. The severity of corrosion depends on the local soil conditions and changes in the immediate environment along the equipment metal surface.
- b) Poor condition of a protective coating is a tell tale sign of potential corrosion damage.

#### **4.3.9.6 Prevention / Mitigation**

Soil corrosion of carbon steel can be minimized through the use of special backfill, coatings and cathodic protection. The most effective protection is a combination of a corrosion resistant coating and a cathodic protection system.

#### **4.3.9.7 Inspection and Monitoring**

- a) The most common method used for monitoring underground structures is measuring the structure to soil potential using dedicated reference electrodes near the structure (corrected for IR drop error). Cathodic protection should be performed and monitored in accordance with NACE RP 0169.



- b) There are many techniques for inspecting buried or on-grade metallic components. Piping may be inspected by inline inspection devices, guided ultrasonic thickness tools, indirectly by pressure testing, or visually by evaluation. The same or similar techniques may be used on other structures.

#### **4.3.9.8     *Related Mechanisms***

Galvanic corrosion (see 4.3.1).

#### **4.3.9.9     *References***

1. API RP 580, Recommended Practice for Risk Based Inspection, American Petroleum Institute, Washington, D.C., 2008.
2. API RP 581, Risk-Based Inspection Technology, American Petroleum Institute, Washington, D.C., 2008.
3. Peabody, A.W., "Control of Pipeline Corrosion," NACE International, Houston, TX, 1967.
4. Morgan, John, "Cathodic Protection," NACE International, Houston, TX, 1987.
5. O'Day, D. Kelly, "External Corrosion in Distribution Systems," AWWA Journal, October, 1989.
6. Parker, Marshall E., "Pipe Line Corrosion and Cathodic Protection," Gulf Publishing Company, TX, 1954.
7. Romanoff, M., "Underground Corrosion," NACE International, Houston, TX, 1997.
8. Jones, Denny A., "Principles and Prevention of Corrosion," McMillan Publishing Co., NY, 1992.
9. Herbert H. Uhlig, "Corrosion Handbook," John Wiley and Sons, Inc., 1948.
10. EDM Services, Inc., "Hazardous Liquid Pipeline Risk Assessment," California State Fire Marshal, Pipeline Safety Division, CA, 1993.
11. NACE RP 0169, Standard Recommended Practice: Control of External Corrosion on Underground or Submerged Metallic Piping Systems, NACE International, Houston, TX.



Figure 4-96 – Corrosion of carbon steel pipe at the soil-air interface where the pipe emerges from underground.



Figure 4-97 – Coupons removed from the bottom of an unprotected steel condensate storage tank after 3 years of service. The external surface is shown.

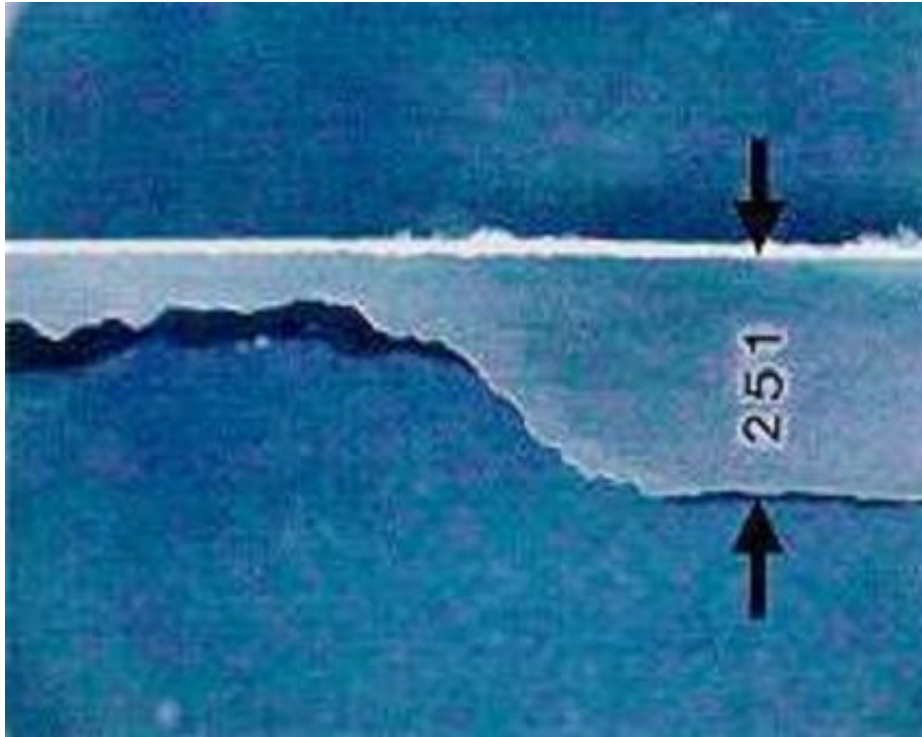


Figure 4-98 – Cross section through location (A) showing severe corrosion. The arrows point to a location that was at the original thickness.

### **4.3.10 Caustic Corrosion**

#### **4.3.10.1 Description of Damage**

Localized corrosion due to the concentration of caustic or alkaline salts that usually occurs under evaporative or high heat transfer conditions. However, general corrosion can also occur depending on alkali or caustic solution strength.

#### **4.3.10.2 Affected Materials**

Primarily carbon steel, low alloy steels and 300 Series SS.

#### **4.3.10.3 Critical Factors**

Major contributing factors are the presence of caustic (NaOH or KOH). The following are sources of caustic:

- a) Caustic is sometimes added to process streams for neutralization or as a reactant.
- b) It is sometimes intentionally added to boiler feedwater at low concentrations or may enter inadvertently during regeneration of demineralizers.
- c) Alkaline salts may also enter process streams through leaks in condensers or process equipment.
- d) Some process units utilize caustic solutions for neutralizing, for removal of sulfur compounds, or for removal of chloride compounds.
- e) A concentrating mechanism must exist to build up the caustic strength.
- f) Caustic may become concentrated by departure from DNB, evaporation and deposition.

#### **4.3.10.4 Affected Units or Equipment**

- a) Caustic corrosion is most often associated with boilers and steam generating equipment including heat exchangers.
- b) Similar concentrating effects of caustic may occur where caustic is added to crude unit charge.
- c) Accelerated localized corrosion can occur in preheat exchangers, furnace tubes and transfer lines, unless the caustic is effectively mixed in the oil stream.
- d) Units that use caustic for removing sulfur compounds from product streams.

#### **4.3.10.5 Appearance or Morphology of Damage**

- a) Typically characterized by localized metal loss which may appear as grooves in a boiler tube or locally thinned areas under insulating deposits ([Figure 4-99](#) and [Figure 4-100](#)).
- b) Deposits may fill corroded depressions and mask damage below. Probing suspect areas with a sharp instrument may be required.
- c) Localized gouging may result along a waterline where corrosives concentrate. In vertical tubes, this may appear as a circumferential groove.
- d) In horizontal or sloped tubes, grooving may appear at the top of the tube or as longitudinal grooves on opposite sides of the tube.
- e) Exposure to high solution strength caustic can result in general corrosion of carbon steel above 175°F (79°C) and very high corrosion rates above 200°F (93°C).

**4.3.10.6 Prevention / Mitigation**

- a) In steam generating equipment, caustic corrosion is best prevented through proper design. Damage can be minimized by reducing the amount of free caustic, by ensuring adequate water flooding and water flow, by ensuring proper burner management to minimize hot spots on heater tubes, and by minimizing the ingress of alkaline producing salts into condensers.
- b) In process equipment, caustic injection facilities should be designed to allow proper mixing and dilution of caustic in order to avoid the concentration of caustic on hot metal surfaces.
- c) Carbon steel and 300 Series SS have serious corrosion problems in high strength caustic solutions above about 150°F (66°C). Alloy 400 and some other nickel base alloys exhibit much lower corrosion rates.

**4.3.10.7 Inspection and Monitoring**

- a) For process equipment, UT thickness gauging is useful to detect and monitor general corrosion due to caustic. However, localized losses due to caustic corrosion may be difficult to locate.
- b) Injection points should be inspected in accordance with API 570.
- c) UT scans and radiography can be used.
- d) Steam generation equipment may require visual inspection with the use a boroscope.

**4.3.10.8 Related Mechanisms**

Caustic corrosion is also referred to as caustic gouging or ductile gouging. A related mechanism is known as Departure from Nucleate Boiling (DNB) as discussed in steam blanketing (See [4.2.11](#)).

**4.3.10.9 References**

1. ASM Metals Handbook, "Failure Analysis and Prevention," Volume 11, ASM International, Materials Park, OH.
2. R.D. Port and H.M. Herro, "The NALCO Guide to Boiler Failure Analysis," McGraw-Hill, Inc., NY, 1991, pp. 58 -70.



Figure 4-99 – I.D. deposits on CS boiler tube with damage due to caustic corrosion.

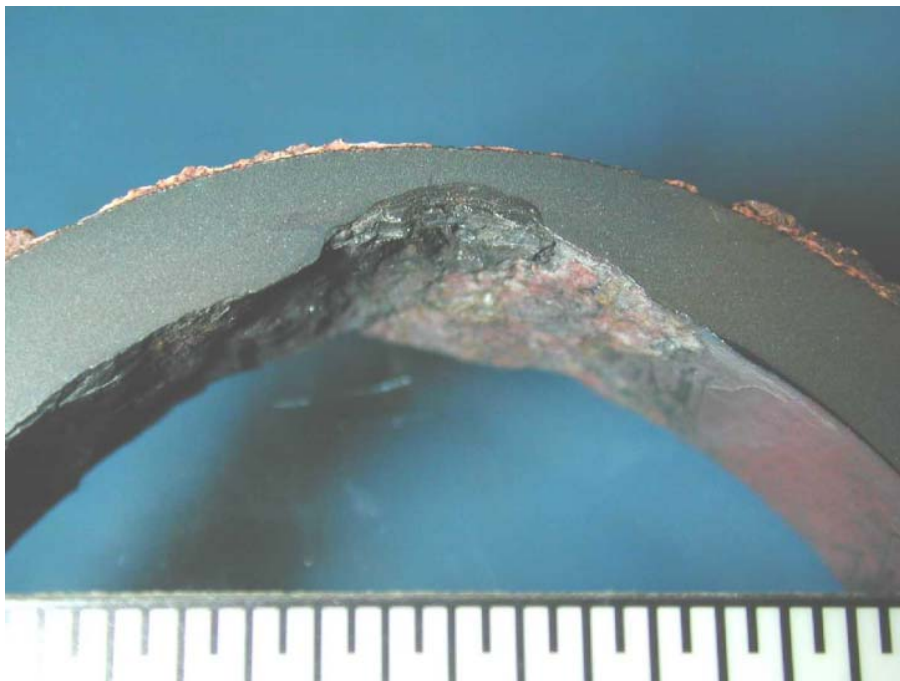


Figure 4-100 – Cross-section of tube in Figure 4-99 showing localized attack due to caustic corrosion.

### 4.3.11 Dealloying

#### 4.3.11.1 *Description of Damage*

- a) Dealloying is a selective corrosion mechanism in which one or more constituents of an alloy are preferentially attacked leaving a lower density (dealloyed) often porous structure.
- b) Component failure may occur suddenly and unexpectedly because mechanical properties of the dealloyed material are significantly degraded.

#### 4.3.11.2 *Affected Materials*

Primarily copper alloys (brass, bronze, tin) as well as Alloy 400 and cast iron.

#### 4.3.11.3 *Critical Factors*

- a) Factors which influence dealloying include the composition of the alloy and exposure conditions including temperature, degree of aeration, pH and exposure time.
- b) Dealloying occurs with several different alloys but is usually limited to very specific alloy-environment combinations.
- c) Exact conditions under which dealloying occurs are often hard to define and damage may occur progressively over many years in service.
- d) Common examples of where dealloying has been found to occur are listed in [Table 4-7](#).

#### 4.3.11.4 *Affected Units or Equipment*

- a) Underground cast iron piping when exposed to certain soils.
- b) In cooling water applications, heat exchanger tubing (brass, Al brass) is susceptible to dealloying in some brackish and seawater applications but often the tubesheets suffer significant damage. Problems may also occur in some fresh or domestic water systems.
- c) Boiler feedwater piping systems and afterboiler components may suffer dealloying including bronze pumps, Monel strainers and brass pressure gage fittings.

#### 4.3.11.5 *Appearance or Morphology of Damage*

- a) There is often a significant color change or a deep etched (corroded) appearance as one element is removed from the alloy. However, depending on the alloy, the outward appearance of the affected material may not be noticeable upon visual inspection, even where the full wall thickness is degraded.
- b) Attack may be uniform through the cross-section (layer-type) or it can be localized (plug-type) ([Figure 4-101](#) and [Figure 4-102](#)).
- c) In some cases, the original material is completely dealloyed yet the component exhibits virtually no dimensional or other visible changes.

#### 4.3.11.6 *Prevention / Mitigation*

- a) It is often difficult to predict whether conditions will be conducive to dealloying in a particular environment or service, so that one must be cognizant of the susceptibility of certain alloys, and the possible resulting consequences.
- b) Resistance to dealloying can sometimes be improved by the addition of certain alloying elements so that a similar alloy with a different composition may be resistant. For example, tin tends to inhibit dealloying of copper alloys; admiralty brass is inhibited by the addition of a very small amount of phosphorous, antimony or arsenic; and dealuminification of aluminum-bronze can be prevented by heat treatment to produce an  $\alpha$  and  $\beta$  microstructure.

- c) Continued degradation of a dealloyed component can only be prevented by altering the exposure conditions or replacing it with a resistant material.
- d) Depending on the alloy-environment combination, cathodic protection or barrier coatings may be effective.

#### **4.3.11.7 Inspection and Monitoring**

- a) Many alloys change color in the affected area, however, scale removal may be required to determine the depth of attack.
- b) Dealloying in brasses is visually evident by a reddish, copper color instead of the yellow brass color.
- c) Graphitic corrosion turns
- d) cast iron charcoal gray and the material can be cut or gouged with a knife.
- e) Metallographic examination may be required to confirm the extent of damage.
- f) A significant reduction in hardness may accompany dealloying, although affected areas may be localized.
- g) Acoustic techniques (loss of “metallic ring”) and ultrasonic attenuation are applicable, but UT thickness measurements are not.
- h) Fitness-For-Service (FFS) analysis of dealloyed components should consider that the dealloyed portion may be brittle and contribute little or no mechanical strength or load bearing capability.

#### **4.3.11.8 Related Mechanisms**

- a) Dealloying is often referred to by the element removed, as in dezincification, destannification, denickelification, dealuminification and graphitic corrosion. Dealloying has also been referred to as selective leaching.
- b) Graphitic corrosion affects cast irons and is further described in [4.3.12](#).

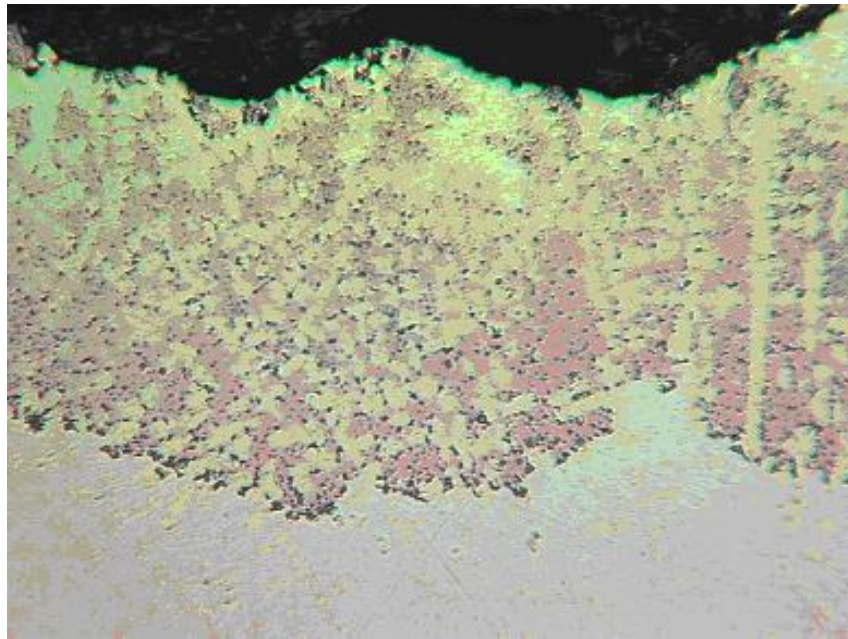
#### **4.3.11.9 References**

1. ASM Metals Handbook, “Corrosion,” Volume 13, ASM International, Materials Park, OH.
2. A. Cohen, “Copper and Copper-Base Alloys,” Process Industries Corrosion – The Theory and Practice, NACE International, Houston, TX, 1986.
3. R.D. Port and H.M. Herro, “The NALCO Guide to Boiler Failure Analysis,” McGraw-Hill, Inc., NY, 1991, pp. 259-263.
4. ASM Metals Handbook, “Failure Analysis and Prevention,” Volume 11, ASM International, Materials Park, OH.

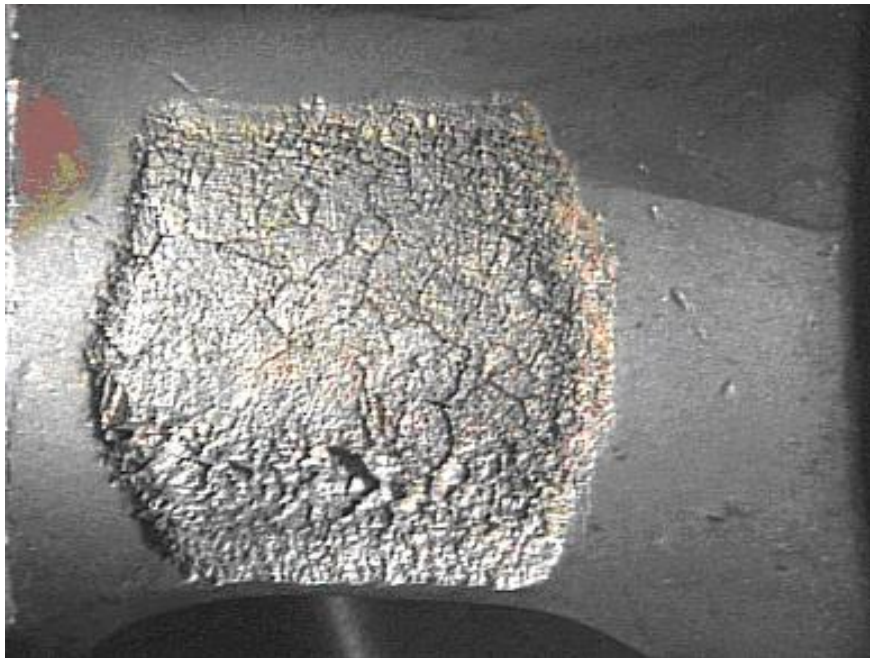


**Table 4-7 – Combinations of Alloys and Environment Subject to Dealloying. (Reference 1)**

<b>Alloy</b>	<b>Environment</b>	<b>Element Removed</b>
Brasses (>15% Zn) *	Many waters, especially stagnant conds.	Zinc (dezincification)
Gray Cast Iron	Soils, many waters	Iron (graphitic corrosion)
Aluminum bronze (primarily w/> 8% Al)	HF acid, acids w/chloride ions, seawater	Aluminum (dealuminification)
Silicon bronzes	High-temp steam and acidic species	Silicon (desiliconification)
Tin bronzes	Hot brine or steam	Tin (destannification)
Copper nickels (70-30)	High heat flux and low water velocity	Nickel (denickelification)
Monel	Hydrofluoric and other acids	Nickel (denickelification)
* The extent of dezincification increases with increasing zinc content.		



**Figure 4-101 – Cross section of a silicon-brass alloy C87500 pump impeller from stagnant fire-water service. Layer-type dezincification depleted the zinc and left this porous red color of the copper. Mag. 50X**



**Figure 4-102 – A zone of denickelification in a Monel valve plug (at the port), due to oxygen contamination in hot hydrofluoric acid.**

### 4.3.12 Graphitic Corrosion

#### 4.3.12.1 Description of Damage

- a) Cast irons are comprised of graphite particles embedded in an iron matrix. Graphitic corrosion is a form of dealloying in which the iron matrix is corroded, leaving corrosion products and porous graphite.
- b) Attack results in a porous structure with a loss of strength, ductility and density. It usually occurs under low pH and stagnant conditions, especially in contact with soils or waters high in sulfates.

#### 4.3.12.2 Affected Materials

Primarily gray cast iron, but also nodular and malleable cast irons experience graphitic corrosion. However, nodular and malleable cast irons tend to crumble when attacked. White iron is not subject to this damage because there is no free graphite.

#### 4.3.12.3 Critical Factors

- a) Graphitic corrosion occurs with several different cast iron alloys but is usually limited to very specific microstructure-environment combinations. Factors that influence graphitic corrosion include the composition of the alloy and exposure conditions including temperature, degree of aeration, pH and exposure time.
- b) Damage occurs in the presence of moisture or an aqueous phase, usually below 200°F (93°C).
- c) Damage may take many months or years to progress but can increase in severity if the pH drops. Much of the damage occurs during stagnant conditions when high concentrations of sulfates are present.
- d) Graphite is cathodic to the iron matrix. The iron matrix preferentially corrodes and cathodically protects the graphite in certain conductive waters or soils.
- e) Graphitic corrosion may affect adjacent components by causing galvanic corrosion.

#### 4.3.12.4 Affected Units or Equipment

Graphitic corrosion can occur in soft water, salt water, mine waters, dilute acids and in underground piping as well as in boiler feedwater equipment. Typical examples include feedwater piping, pumps (including pump impellers), valves, and underground cast iron pipe. Fire water systems are particularly vulnerable.

#### 4.3.12.5 Appearance or Morphology of Damage

- a) Damage may be widespread or it may also occur in localized areas in which the majority of the component is unaffected.
- b) The damage may not be noticeable upon visual inspection even where the full wall thickness is degraded.
- c) Damaged areas will be soft and easily gouged with a knife or hand tool.
- d) Metallographic examination may be required to confirm the extent of damage ([Figure 4-103](#) through [Figure 4-110](#)).

#### 4.3.12.6 Inspection and Monitoring

- a) UT is not a good method for detecting damage.
- b) Acoustic techniques (loss of “metallic ring”) and ultrasonic attenuation are applicable.
- c) A significant reduction in hardness may accompany dealloying, although affected areas may be localized.

**4.3.12.7 Prevention / Mitigation**

- a) It is often difficult to predict if exposure conditions will cause this form of dealloying in a particular environment or service. One must be aware of the potential susceptibility of cast irons.
- b) Internal graphitic corrosion can be prevented by coatings and/or cement linings.
- c) External graphitic corrosion can be prevented by external coatings or cathodic protection in severely corrosive soils.

**4.3.12.8 Related Mechanisms**

Also known as selective leaching, graphitic corrosion is a form of dealloying (see [4.3.11](#)) of cast irons. It should not be confused with graphitization, the decomposition of carbides at high temperatures (see [4.2.1](#)).

**4.3.12.9 References**

1. R.D. Port and H.M. Herro, "The NALCO Guide to Boiler Failure Analysis," McGraw-Hill, Inc., NY, 1991, pp. 259-263.
2. ASM Metals Handbook, "Failure Analysis and Prevention," Volume 11, ASM International, Materials Park, OH.
3. ASM Metals Handbook, "Corrosion," Volume 13, ASM International, Materials Park, OH.



**Figure 4-103 – Graphitic Corrosion of cast iron impeller due to glycol acidification.**



**Figure 4-104 – Cut away of cast iron impeller shown above. The dark phase around the outside perimeter (at arrows) is graphite which surround the unaffected metal in the middle.**



**Figure 4-105 – View of the outside of an underground concrete-lined salt water service line that failed from graphitic corrosion.**



**Figure 4-106 – View of concrete lining inside the failed line shown in Figure 105.**

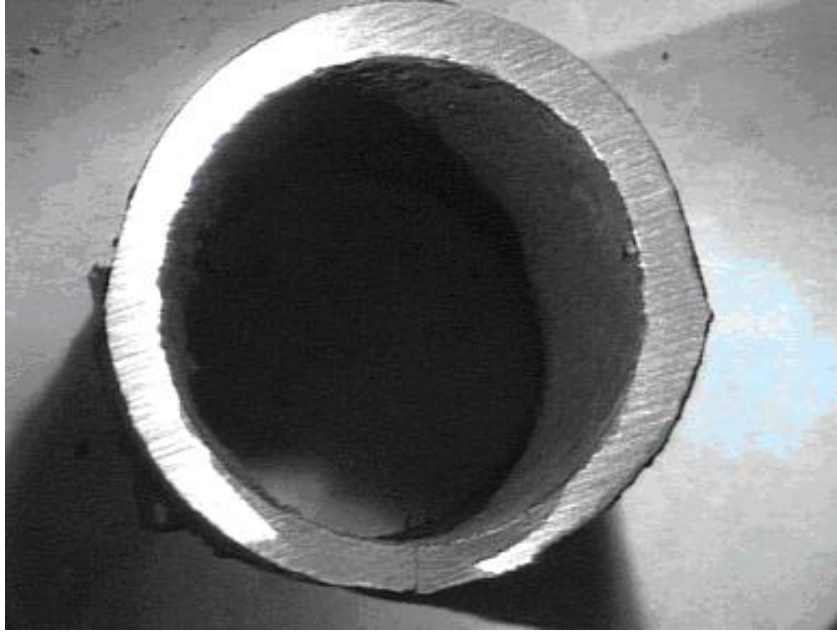


Figure 4-107 – Cross section of a gray cast iron drainpipe showing charcoal colored thru-wall graphitic corrosion encroaching from both sides. Note the through wall crack at the bottom.

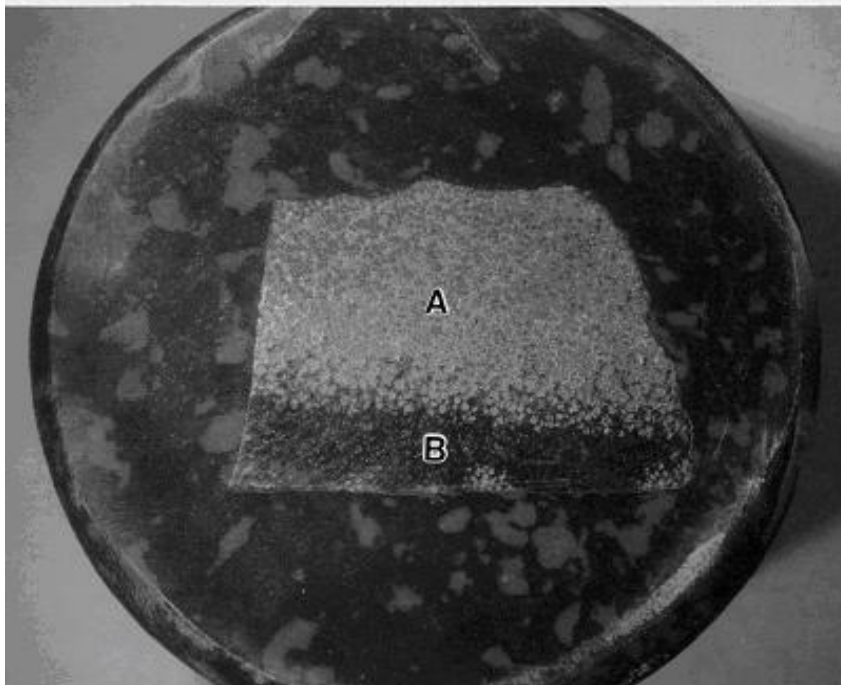
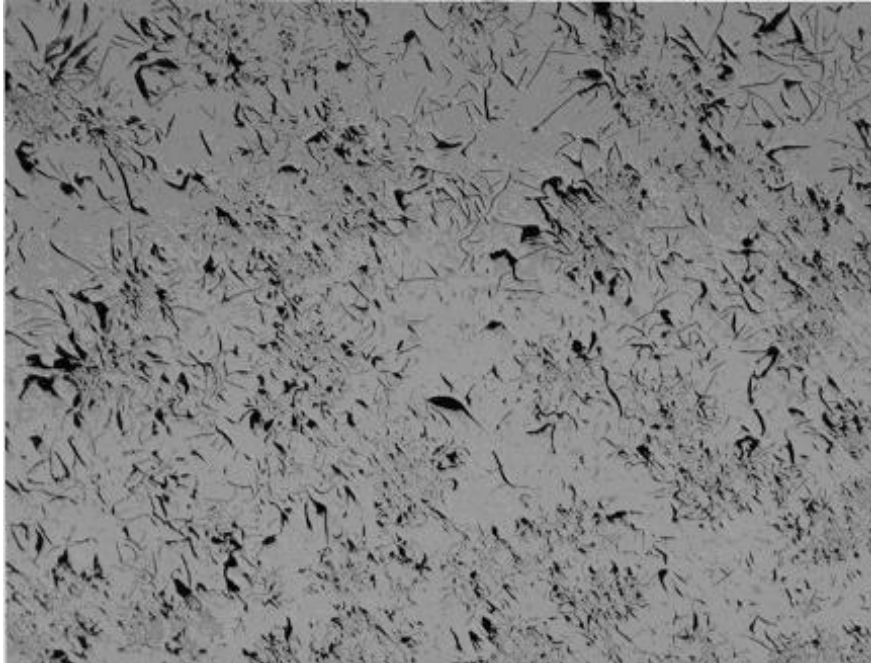


Figure 4-108 – Cross section of a gray cast iron pipe with graphitic corrosion coming from O.D. (Point B).



**Figure 4-109 – Higher magnification view of unaffected area “A” shown in Figure 4-108.**



**Figure 4-110 – Higher magnification view of the damage from shown in 4-108 (area “B”).**



## 4.4 High Temperature Corrosion [ $>400^{\circ}\text{F}$ ( $204^{\circ}\text{C}$ )]

### 4.4.1 Oxidation

#### 4.4.1.1 *Description of Damage*

- a) Oxygen reacts with carbon steel and other alloys at high temperature converting the metal to oxide scale.
- b) It is most often present as oxygen is in the surrounding air (approximately 20%) used for combustion in fired heaters and boilers.

#### 4.4.1.2 *Affected Materials*

- a) All iron based materials including carbon steel and low alloy steels, both cast and wrought.
- b) All 300 Series SS, 400 Series SS and nickel base alloys also oxidize to varying degrees, depending on composition and temperature.

#### 4.4.1.3 *Critical Factors*

- a) The primary factors affecting high temperature oxidation are metal temperature and alloy composition.
- b) Oxidation of carbon steel begins to become significant above about  $1000^{\circ}\text{F}$  ( $538^{\circ}\text{C}$ ). Rates of metal loss increase with increasing temperature.
- c) In general, the resistance of carbon steel and other alloys is determined by the chromium content of the material. Increasing chromium levels produce a more protective oxide scale. The 300 Series SS are resistant to scaling up to about  $1500^{\circ}\text{F}$  ( $816^{\circ}\text{C}$ ). See [Table 4-8](#).
- d) The presence of water vapor can significantly accelerate oxidation rates of some steels including 9Cr-1Mo (Reference 4.)

#### 4.4.1.4 *Affected Units or Equipment*

Oxidation occurs in fired heaters and boilers as well as other combustion equipment, piping and equipment that operates in high temperature environments when metal temperatures exceed about  $1000^{\circ}\text{F}$  ( $538^{\circ}\text{C}$ ).

#### 4.4.1.5 *Appearance or Morphology of Damage*

- a) Most alloys, including carbon steels and low alloy steels, suffer general thinning due to oxidation. Usually, the component will be covered on the outside surface with an oxide scale, depending on the temperature and exposure time ([Figure 4-111](#) to [4-113](#)).
- b) 300 Series SS and nickel alloys generally have a very thin dark scale unless exposed to extremely high temperatures where metal loss rates are excessive.

#### 4.4.1.6 *Prevention / Mitigation*

- a) Resistance to oxidation is best achieved by upgrading to a more resistant alloy.
- b) Chromium is the primary alloying element that affects resistance to oxidation. Other alloying elements, including silicon and aluminum, are effective but their concentrations are limited due to adverse affects on mechanical properties. They are often used in special alloys for applications such as heater supports, burner tips and components for combustion equipment.

#### 4.4.1.7 *Inspection and Monitoring*

- a) Process conditions should be monitored for establishing trends of high temperature equipment where oxidation can occur.

- b) Temperatures can be monitored through the use of tubeskin thermocouples and/or infrared thermography.
- c) Loss in thickness due to oxidation is usually measured using external ultrasonic thickness measurements.

#### **4.4.1.8     *Related Mechanisms***

Oxidation damage referred to in this section is due to surface scaling. Some damage mechanisms result in internal oxidation which is outside the scope of this document.

#### **4.4.1.9     *References***

1. API RP 581, Risk-Based Inspection Technology, American Petroleum Institute, Washington, D.C., 2008.
2. J. Gutzeit et al., "Corrosion in Petroleum Refining and Petrochemical Operations" ASM Metals Handbook, Volume 13, ASM International, OH, 1987, pp. 1262 – 1288.
3. "Corrosion Basics – An Introduction," NACE International, Houston, TX, 1984, pp. 276 - 288.
4. F. Dettenwanger et al., "The influence of Si, W and water vapor on the oxidation behavior of 9Cr steels", Paper No. 01151, NACE International, Houston, TX, 2001.

**Table 4-8 – Estimated Corrosion Rates (mpy) for Oxidation (Reference 1).**

Material	Maximum Metal Temperature (°F)											
	925	975	1025	1075	1125	1175	1225	1275	1325	1375	1425	1475
CS	2	4	6	9	14	22	33	48	--	--	--	--
1 1/4 Cr	2	3	4	7	12	18	30	46	--	--	--	--
2 1/4 Cr	1	1	2	4	9	14	24	41	--	--	--	--
5 Cr	1	1	1	2	4	6	15	35	65	--	--	--
7 Cr	1	1	1	1	1	2	3	6	17	37	60	--
9 Cr	1	1	1	1	1	1	1	2	5	11	23	40
12 Cr	1	1	1	1	1	1	1	1	3	8	15	30
304 SS	1	1	1	1	1	1	1	1	1	2	3	4
309 SS	1	1	1	1	1	1	1	1	1	1	2	3
310 SS / HK	1	1	1	1	1	1	1	1	1	1	1	2
800 H / HP	1	1	1	1	1	1	1	1	1	1	1	2

Material	Maximum Metal Temperature (°F)											
	1525	1575	1625	1675	1725	1775	1825	1875	1925	1975	2025	2075
CS	--	--	--	--	--	--	--	--	--	--	--	--
1 1/4 Cr	--	--	--	--	--	--	--	--	--	--	--	--
2 1/4 Cr	--	--	--	--	--	--	--	--	--	--	--	--
5 Cr	--	--	--	--	--	--	--	--	--	--	--	--
7 Cr	--	--	--	--	--	--	--	--	--	--	--	--
9 Cr	60	--	--	--	--	--	--	--	--	--	--	--
12 Cr	50	--	--	--	--	--	--	--	--	--	--	--
304 SS	6	9	13	18	25	35	48	--	--	--	--	--
309 SS	4	6	8	10	13	16	20	30	40	50	--	--
310 SS / HK	3	4	5	7	8	10	13	15	19	23	27	31
800 H / HP	3	4	6	8	10	13	17	21	27	33	41	50

Material	Maximum Metal Temperature (°C)											
	496	524	552	579	607	635	663	691	718	746	774	802
CS	0.05	0.1	0.15	0.23	0.36	0.56	0.84	1.22	--	--	--	--
1 1/4 Cr	0.05	0.08	0.1	0.18	0.3	0.46	0.76	1.17	--	--	--	--
2 1/4 Cr	0.03	0.03	0.05	0.1	0.23	0.36	0.61	1.04	--	--	--	--
5 Cr	0.03	0.03	0.03	0.05	0.1	0.15	0.38	0.89	1.65	--	--	--
7 Cr	0.03	0.03	0.03	0.03	0.03	0.05	0.08	0.15	0.43	0.94	1.52	--
9 Cr	0.03	0.03	0.03	0.03	0.03	0.03	0.03	0.05	0.13	0.28	0.58	1.02
12 Cr	0.03	0.03	0.03	0.03	0.03	0.03	0.03	0.03	0.08	0.2	0.38	0.76
304 SS	0.03	0.03	0.03	0.03	0.03	0.03	0.03	0.03	0.03	0.05	0.08	0.1
309 SS	0.03	0.03	0.03	0.03	0.03	0.03	0.03	0.03	0.03	0.03	0.05	0.08
310 SS / HK	0.03	0.03	0.03	0.03	0.03	0.03	0.03	0.03	0.03	0.03	0.03	0.05
800 H / HP	0.03	0.03	0.03	0.03	0.03	0.03	0.03	0.03	0.03	0.03	0.03	0.05

Material	Maximum Metal Temperature (°F)											
	1525	1575	1625	1675	1725	1775	1825	1875	1925	1975	2025	2075
CS	--	--	--	--	--	--	--	--	--	--	--	--
1 1/4 Cr	--	--	--	--	--	--	--	--	--	--	--	--
2 1/4 Cr	--	--	--	--	--	--	--	--	--	--	--	--
5 Cr	--	--	--	--	--	--	--	--	--	--	--	--
7 Cr	--	--	--	--	--	--	--	--	--	--	--	--
9 Cr	60	--	--	--	--	--	--	--	--	--	--	--
12 Cr	50	--	--	--	--	--	--	--	--	--	--	--
304 SS	6	9	13	18	25	35	48	--	--	--	--	--
309 SS	4	6	8	10	13	16	20	30	40	50	--	--
310 SS / HK	3	4	5	7	8	10	13	15	19	23	27	31
800 H / HP	3	4	6	8	10	13	17	21	27	33	41	50

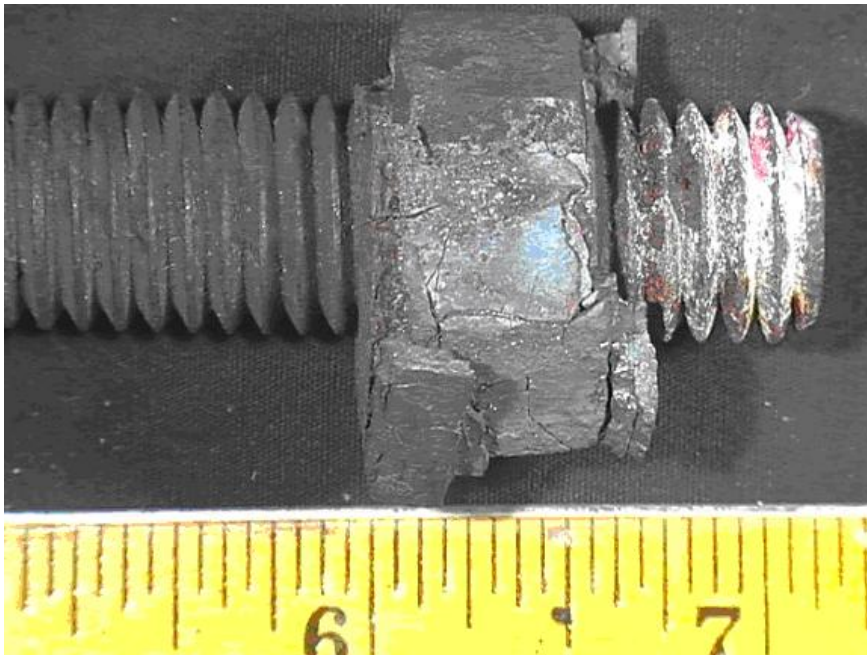


Figure 4-111 – Oxidation of a carbon steel nut on a stainless steel stud at 1300°F (704°C).

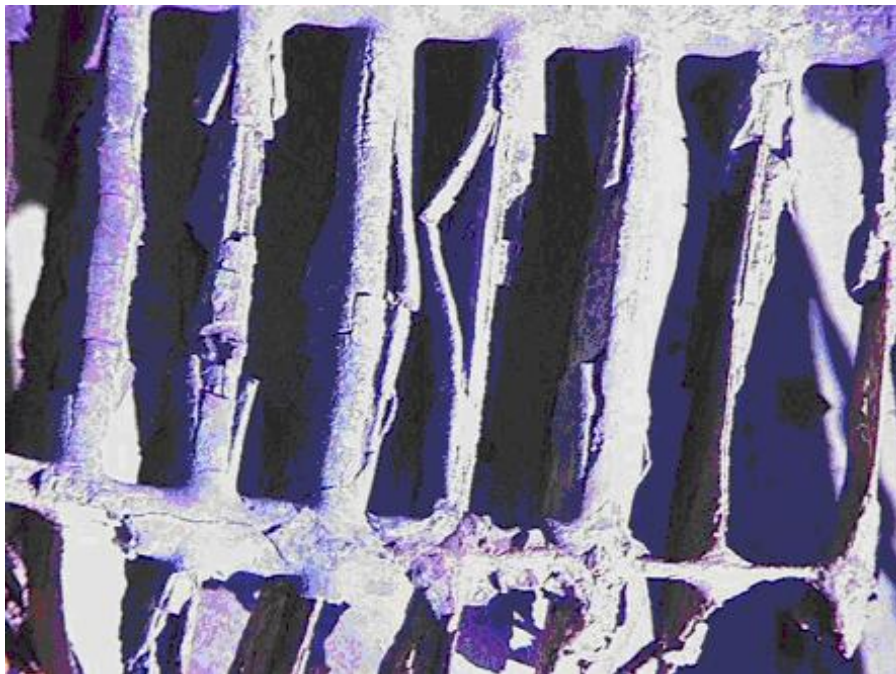


Figure 4-112 – Oxidation of a carbon steel grid from a sulfur reactor.



**Figure 4-113 – Oxidation of the O.D. of a carbon steel furnace transfer line.**

## 4.4.2 Sulfidation

### 4.4.2.1 Description of Damage

Corrosion of carbon steel and other alloys resulting from their reaction with sulfur compounds in high temperature environments. The presence of hydrogen accelerates corrosion. This mechanism is also known as sulfidic corrosion.

### 4.4.2.2 Affected Materials

- a) All iron based materials including carbon steel and low alloy steels, 300 Series SS and 400 Series SS.
- b) Nickel base alloys are also affected to varying degrees depending on composition, especially chromium content.
- c) Copper base alloys form sulfide at lower temperatures than carbon steel.

### 4.4.2.3 Critical Factors

- a) Major factors affecting sulfidation are alloy composition, temperature and concentration of corrosive sulfur compounds.
- b) Susceptibility of an alloy to sulfidation is determined by its ability to form protective sulfide scales.
- c) Sulfidation of iron-based alloys usually begins at metal temperatures above 500°F (260°C). The typical effects of increasing temperature, chromium content and sulfur content on metal loss are shown in [Figure 4-114](#) and [Figure 115](#).
- d) Note: These graphs are provided for reference only for general estimating of corrosion behavior and trends, and should not be used to make an exact determination of corrosion rates. The references at the end of this section should be consulted for additional background on the development of these curves.
- e) In general, the resistance of iron and nickel base alloys is determined by the chromium content of the material. Increasing the chromium content significantly increases resistance to sulfidation. 300 Series SS, such as Types 304, 316, 321 and 347, are highly resistant in most refining process environments. Nickel base alloys are similar to stainless steels in that similar levels of chromium provide similar resistance to sulfidation.
- f) Crude oils, coal and other hydrocarbon streams contain sulfur at various concentrations. Total sulfur content is made up of many different sulfur-containing compounds.
- g) Sulfidation is primarily caused by H<sub>2</sub>S and other reactive sulfur species as a result of the thermal decomposition of sulfur compounds at high temperatures. Some sulfur compounds react more readily to form H<sub>2</sub>S. Therefore, it can be misleading to predict corrosion rates based on weight percent sulfur alone.
- h) A sulfide scale on the surface of the component offers varying degrees of protection depending on the alloy and the severity of the process stream.

### 4.4.2.4 Affected Units or Equipment

- a) Sulfidation occurs in piping and equipment in high temperature environments where sulfur-containing streams are processed.
- b) Common areas of concern are the crude, FCC, coker, vacuum, visbreaker and hydroprocessing units.
- c) Heaters fired with oil, gas, coke and most other sources of fuel may be affected depending on sulfur levels in the fuel.
- d) Boilers and high temperature equipment exposed to sulfur-containing gases can be affected.

**4.4.2.5 Appearance or Morphology of Damage**

- a) Depending on service conditions, corrosion is most often in the form of uniform thinning but can also occur as localized corrosion or high velocity erosion-corrosion damage (Figure 4-116 to 4-120).
- b) A sulfide scale will usually cover the surface of components. Deposits may be thick or thin depending on the alloy, corrosiveness of the stream, fluid velocities and presence of contaminants .

**4.4.2.6 Prevention / Mitigation**

- a) Resistance to sulfidation is generally achieved by upgrading to a higher chromium alloy.
- b) Piping and equipment constructed from solid or clad 300 Series SS or 400 Series SS can provide significant resistance to corrosion.
- c) Aluminum diffusion treatment of low alloy steel components is sometimes used to reduce sulfidation rates and minimize scale formation, however, it may not offer complete protection. 300 Series SS catalyst support screens in hydroprocessing reactors can also be treated to prolong life.

**4.4.2.7 Inspection and Monitoring**

- a) Process conditions should be monitored for increasing temperatures and/or changing sulfur levels.
- b) Temperatures can be monitored through the use of tubeskin thermocouples and/or infrared thermography.
- c) Evidence of thinning can be detected using external ultrasonic thickness measurements and profile radiography.
- d) Proactive and retroactive PMI programs are used for alloy verification and to check for alloy mix-ups in services where sulfidation is anticipated (Reference 7).

**4.4.2.8 Related Mechanisms**

Sulfidation is also known as sulfidic corrosion. High temperature sulfidation in the presence of hydrogen is covered in 5.1.1.5.

**4.4.2.9 References**

1. H.F. McConomy, "High Temperature Sulfidic Corrosion in Hydrogen-Free Environments," API Proceedings, Vol. 43, (III), pp. 78-96, 1963.
2. J. Gutzeit, "High Temperature Sulfidic Corrosion of Steels", Process Industries Corrosion – The Theory and Practice," NACE International, Houston, TX, 1986, pp. 171-189.
3. ASM Metals Handbook, "Corrosion in Petroleum Refining and Petrochemical Operations," Volume 13, ASM International, Materials Park, OH.
4. E. B Backenstow et al, " High Temperature Hydrogen Sulfide Corrosion", CORROSION, Vol. 12, No. 1, 1956, pp 6t-16t.
5. NACE Task Group 176 Draft Report, "Overview of Sulfidic Corrosion in Petroleum Refining", NACE International, Houston, TX, 2003.
6. API RP 939-C Guidelines for Avoiding Sulfidation Corrosion Failures in Oil Refineries, American Petroleum Institute, Washington, D.C.,.
7. API RP 578, "Material Verification Program for New and Existing Alloy Piping Systems", American Petroleum Institute, Washington, D.C.



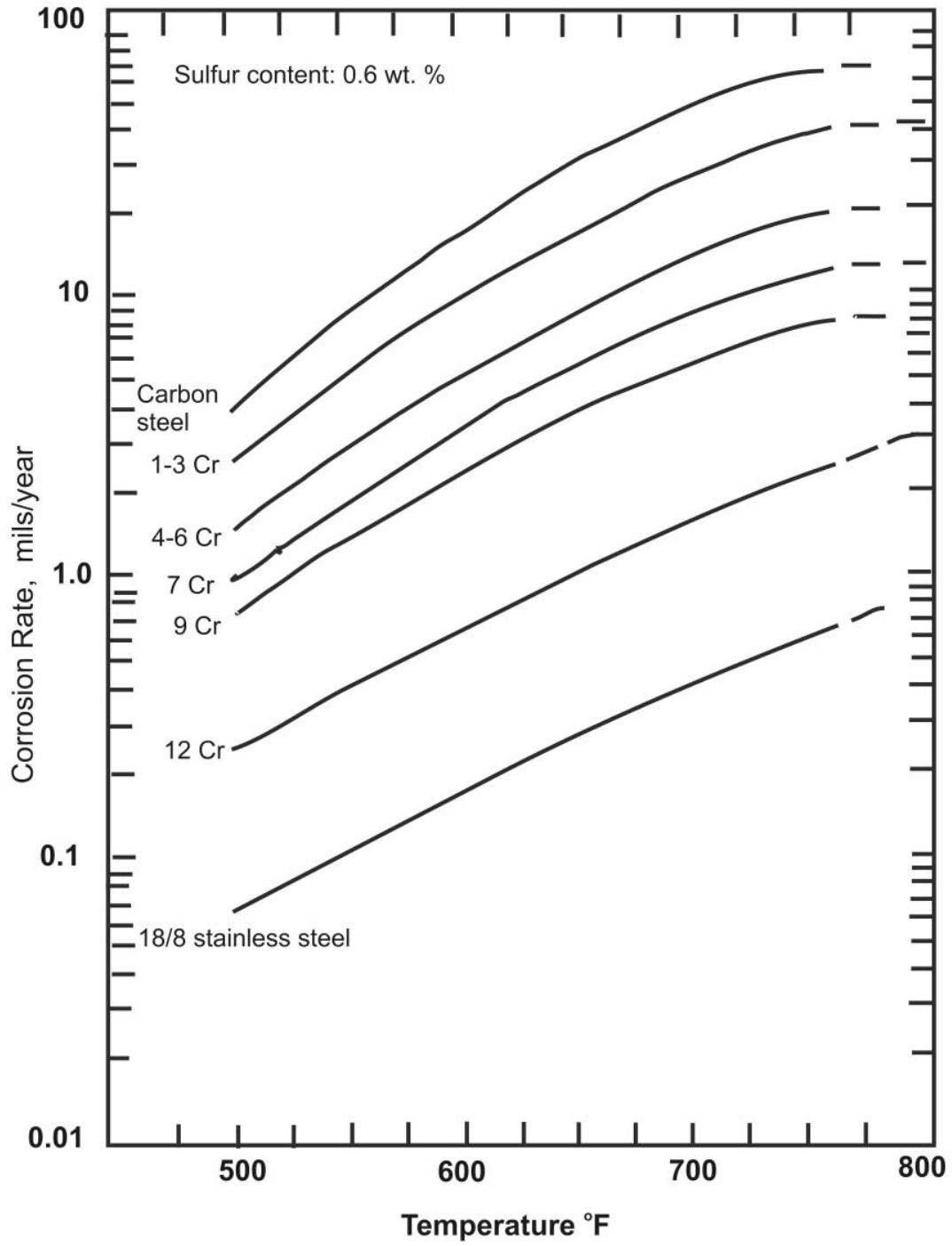


Figure 4-114 – Modified McConomy curves showing typical effect of temperature on high temperature sulfidation of steels and stainless steels. (Reference 3)

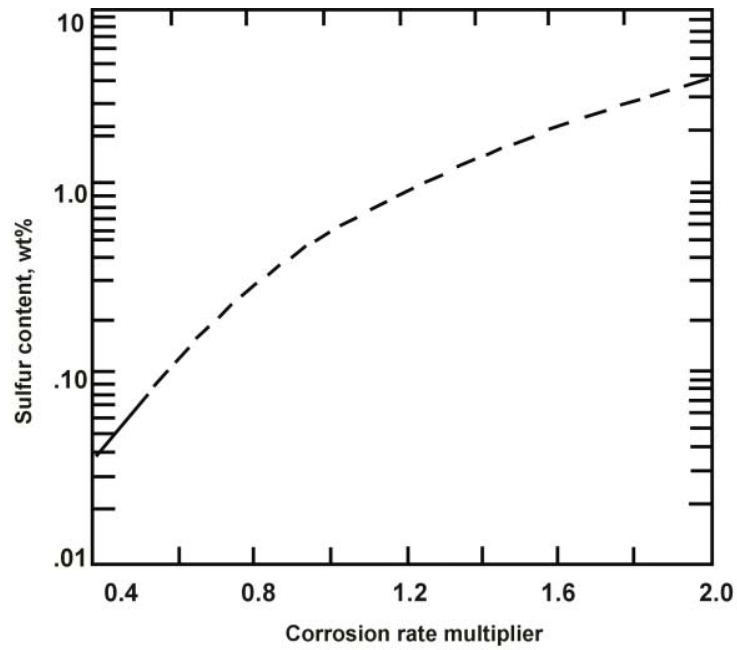


Figure 4-115 – Multiplier for corrosion rates in Figure 4-112 based on differing sulfur content of process fluid. (Reference 3)



Figure 4-116 – Sulfidation failure of NPS 8 carbon steel pipe. Note the relatively uniform thinning that resulted in a sizeable rupture.



**Figure 4-117 – Sulfidation failure illustrating the effect of accelerated corrosion due to low silicon content. This 8 inch NPS pipe section in FCC bottoms piping was in service at 150 psig (1Mpa) at 650° to 700°F (340° to 370°C). The piping sketch in Figure 118 illustrates the difference in corrosion rate as compared to adjacent high-silicon components.**

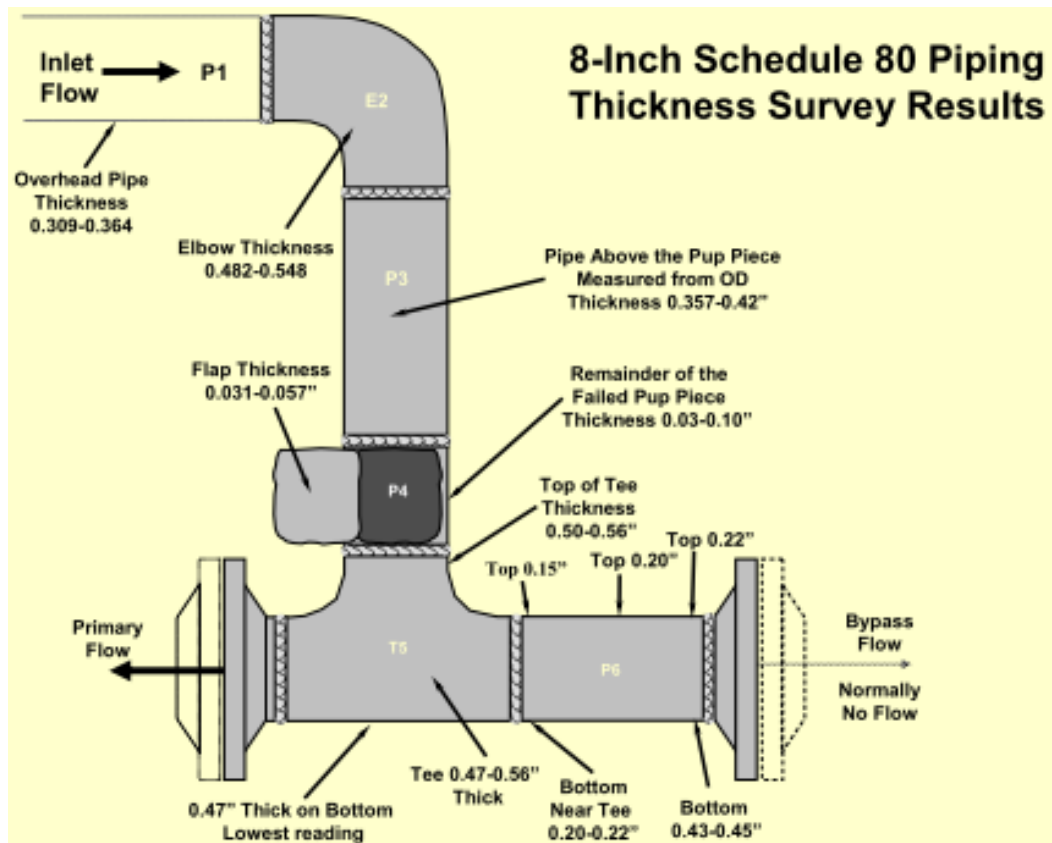


Figure 4-118 – Thickness survey of 8 inch pipe shown in Figure 4-117 above.



Figure 4-119 – Sulfidation failure of carbon steel sight glass nipple on the right after 2 years in crude unit. Original thickness is shown on left for comparison. Material was supposed to be 9Cr-1Mo.



**Figure 4-120 – Sulfidation failure of piping elbow.**

### 4.4.3 Carburization

#### 4.4.3.1 *Description of Damage*

Carbon is absorbed into a material at elevated temperature while in contact with a carbonaceous material or carburizing environment.

#### 4.4.3.2 *Affected Materials*

Carbon steel and low alloy steels, 300 Series SS and 400 Series SS, cast stainless steels, nickel base alloys with significant iron content (e.g., Alloys 600 and 800) and HK/HP alloys.

#### 4.4.3.3 *Critical Factors*

- a) Three conditions must be satisfied:
  - 1) Exposure to a carburizing environment or carbonaceous material.
  - 2) Temperature high enough to allow diffusion of carbon into the metal [typically above 1100°F (593°C)].
  - 3) Susceptible material.
- b) Conditions favoring carburization include a high gas phase carbon activity (hydrocarbons, coke, gases rich in CO, CO<sub>2</sub>, methane, ethane) and low oxygen potential (minimal O<sub>2</sub> or steam).
- c) Initially, carbon diffuses into the component at a high rate and then tapers off as the depth of carburization increases.
- d) In carbon steels and low alloy steels, carbon reacts to form a hard, brittle structure at the surface that may crack or spall upon cooling.
- e) 300 Series SS are more resistant than carbon steel and the low alloy steels due to higher chromium and nickel content.
- f) Carburization can result in the loss of high temperature creep ductility, loss of ambient temperature mechanical properties (specifically toughness/ductility), loss of weldability, and corrosion resistance.

#### 4.4.3.4 *Affected Units or Equipment*

- a) Fired heater tubes are the most common type of equipment susceptible to carburization in the environments mentioned earlier.
- b) Coke deposits are a source of carbon that may promote carburization, particularly during decoking cycles where temperatures exceed the normal operating temperatures, accelerating the carburization.
- c) Carburization is sometimes found in heater tubes in catalytic reformers and coker units or other heaters where steam/air decoking is performed.
- d) Carburization is also encountered in ethylene pyrolysis and steam reformer furnaces. Significant carburization occurs during decoking cycles.

#### 4.4.3.5 *Appearance or Morphology of Damage*

- a) The depth of carburization can be confirmed by metallography. [Figure 4-121](#) to [4-122](#).
- b) Carburization can be confirmed by substantial increases in hardness and loss in ductility.
- c) In a more advanced stage, there may be a volumetric increase in the affected component.
- d) A change (increase) in the level of ferromagnetism can occur in some alloys.

- e) Carburization results in the formation of metal carbides depleting the surrounding matrix of the carbide-forming element.

#### **4.4.3.6 Prevention / Mitigation**

- a) Select alloys with adequate resistance to carburization including alloys with a strong surface oxide or sulfide film formers (silicon and aluminum).
- b) Reduce the carbon activity of the environment through lower temperatures and higher oxygen/sulfur partial pressures. Sulfur inhibits carburization and is often added in the process stream in small amounts in steam/gas cracking in olefin and thermal hydrodealkylation units.

#### **4.4.3.7 Inspection and Monitoring**

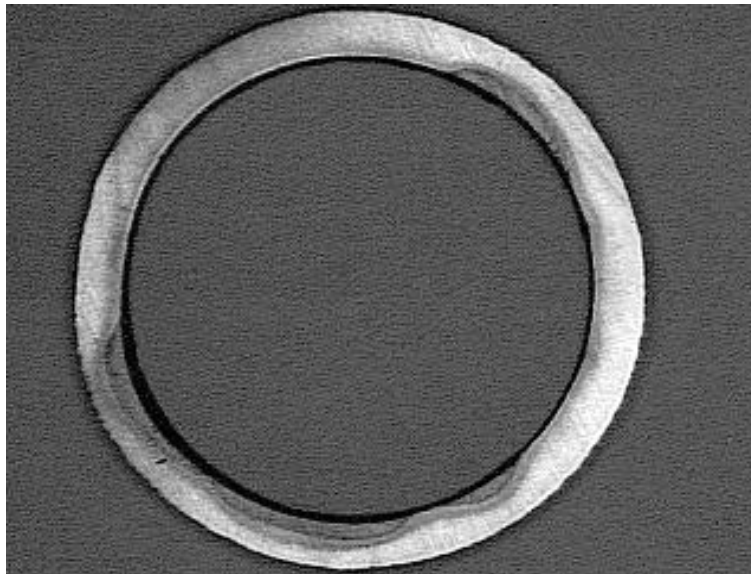
- a) Inspection for carburization in the initial stages of attack is difficult. If the process side surfaces are accessible, hardness testing and field metallography can be used. Destructive sampling and magnetic based techniques (Eddy Current) have also been used.
- b) Inspection techniques based on determining increased levels of ferromagnetism (magnetic permeability) are also useful for alloys that are paramagnetic when initially installed (austenitic alloys). However, surface oxides may interfere with the results.
- c) In the advanced stages of carburization where cracking has initiated, RT, UT and some magnetic techniques may be used.

#### **4.4.3.8 Related Mechanisms**

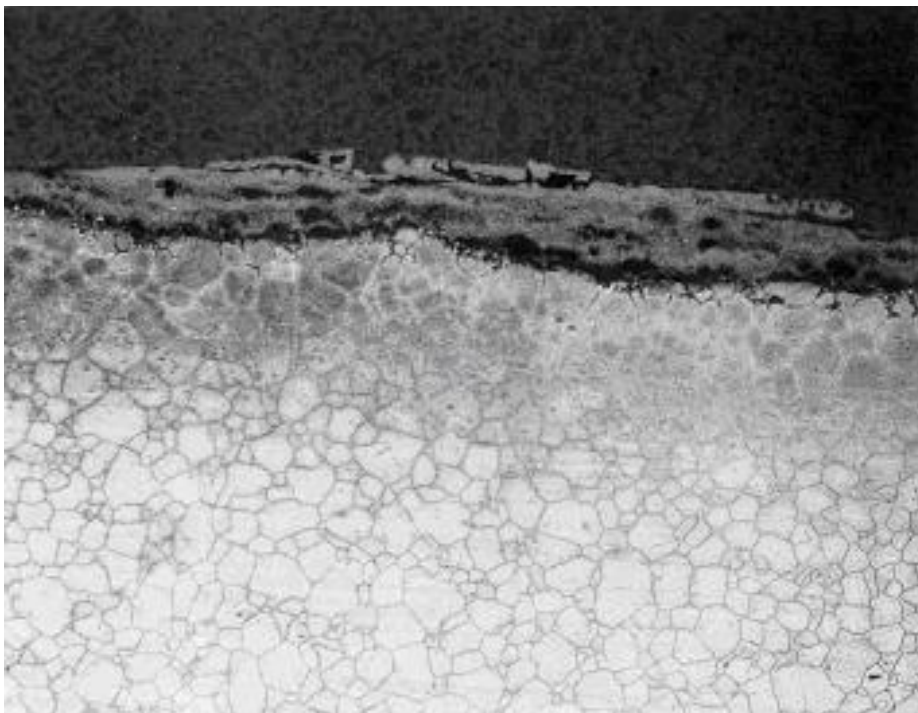
A severe form of carburization known as metal dusting is discussed in [4.4.5](#).

#### **4.4.3.9 References**

1. ASM Metals Handbook, "Corrosion," Volume 13, ASM International, Materials Park, OH.
2. Dr. Hans J. Grabke, "Carburization," Part 1: State-of-the-Art Review; Part 2: Best Practices for Testing Alloys, MTI Publication No. 52.
3. API RP 939-C "Guidelines for Avoiding Sulfidation Corrosion Failures in Oil Refineries", American Petroleum Institute, Washington, D.C..



**Figure 4-121 – Carburization (dark areas) of an HP-modified tube from an ethylene furnace after 3 years at 1900°F (1038°C).**



**Figure 4-122 – A photomicrograph of a cross-section of a 304H cyclone from a fluid coker showing surface carburization after 24 years. Mag. 35X.**



#### **4.4.4 Decarburization**

##### **4.4.4.1 Description of Damage**

A condition where steel loses strength due the removal of carbon and carbides leaving only an iron matrix. Decarburization occurs during exposure to high temperatures, during heat treatment, from exposure to fires, or from high temperature service in a gaseous environment.

##### **4.4.4.2 Affected Materials**

Carbon steels and low alloy steels.

##### **4.4.4.3 Critical Factors**

- a) Time, temperature and carbon activity of the process stream are the critical factors.
- b) The material must be exposed to a gas phase that has a low carbon activity so that carbon in the steel will diffuse to the surface to react with gas phase constituents.
- c) The extent and depth of decarburization is a function of the temperature and exposure time.
- d) Typically, shallow decarburization can slightly decrease the strength of the material, but has no detrimental effect on the overall performance of the component. However, it is indicative that the steel may have been overheated and suggests other effects may be present (e.g. decarburization associated with HTHA in hydrogen services).
- e) Potential loss in room temperature tensile strength and creep strength may occur.

##### **4.4.4.4 Affected Units or Equipment**

- a) Decarburization can occur in almost any equipment that is exposed to elevated temperatures, heat treated or exposed to a fire.
- b) Piping and equipment in hot hydrogen service in hydroprocessing units or catalytic reforming units as well as fired heater tubes can be affected. Pressure vessel components that are hot formed during fabrication can be affected.

##### **4.4.4.5 Appearance or Morphology of Damage**

- a) Damage can be verified by metallography.
- b) Damage occurs on the surface exposed to the gas environment but in extreme cases may be through wall.
- c) The decarburized layer will be free of carbide phases. Carbon steel will be pure iron ([Figure 4-123 to 4-124](#)).

##### **4.4.4.6 Prevention / Mitigation**

- a) Decarburization can be controlled by controlling the chemistry of the gas phase and alloy selection (API RP 941).
- b) Alloy steels with chromium and molybdenum form more stable carbides and are more resistant to decarburization.
- c) Steels operating in high temperature hydrogen environments should be selected in accordance with API RP 941.

##### **4.4.4.7 Inspection and Monitoring**

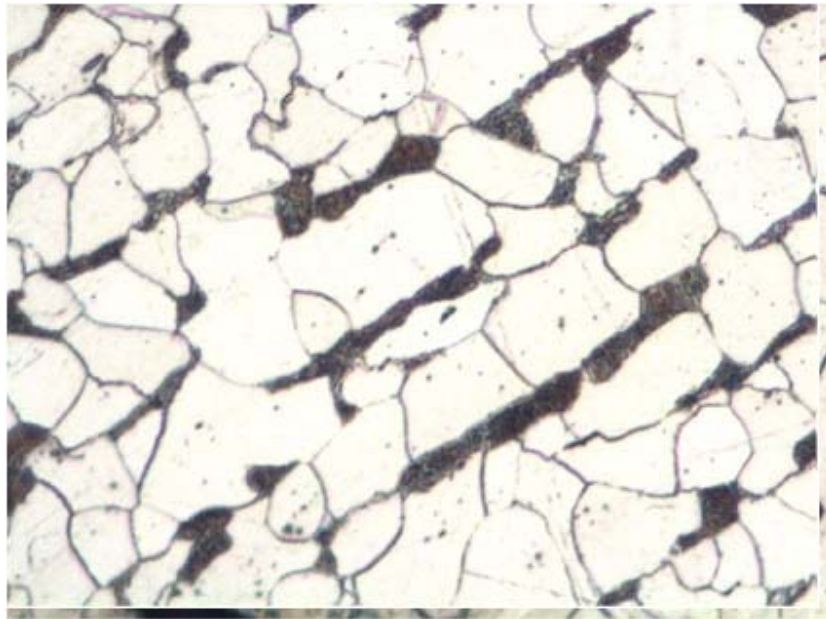
- a) Field Metallography and Replication (FMR) can confirm decarburization.
- b) Decarburization results in a softening that can be confirmed by hardness testing.

**4.4.4.8     *Related Mechanisms***

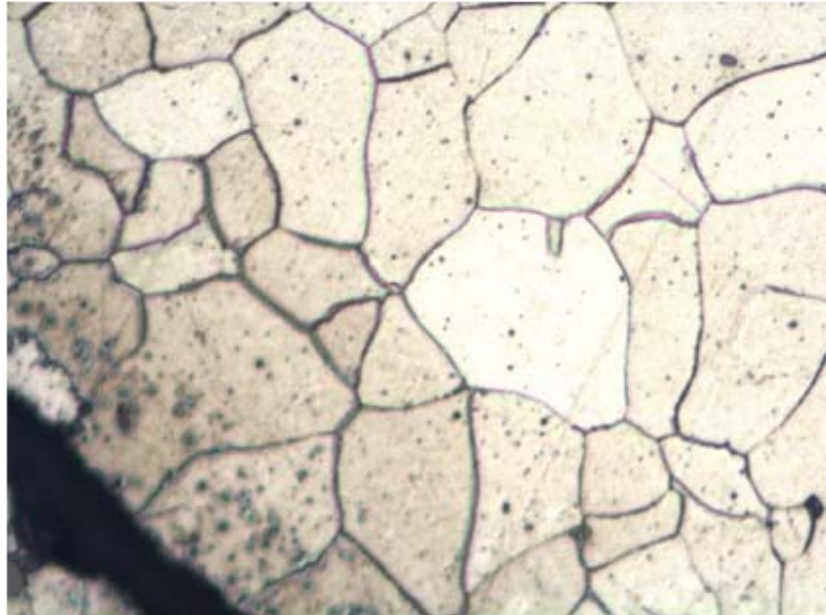
High Temperature Hydrogen Attack (HTHA) (see [5.1.3.1](#)).

**4.4.4.9     *References***

1. ASM Metals Handbook, "Corrosion," Volume 13, ASM International, Materials Park, OH.
2. API RP941, Steels for Hydrogen Service at Elevated Temperatures in Petroleum Refineries and Petrochemical Plants, American Petroleum Institute, Washington, D.C.



**Figure 4-123 – Typical low carbon steel microstructure showing ferrite phase (light grains) and pearlite carbide (dark layered phases).**



**Figure 4-124 – Microstructure illustrating a decarburized low carbon steel where the strength-providing pearlitic phases have been decomposed as a result of the removal of carbon atoms by diffusion to the surface.**

#### **4.4.5 Metal Dusting**

##### **4.4.5.1 Description of Damage**

Metal dusting is form of carburization resulting in accelerated localized pitting which occurs in carburizing gases and/or process streams containing carbon and hydrogen. Pits usually form on the surface and may contain soot or graphite dust.

##### **4.4.5.2 Affected Materials**

Low alloy steels, 300 Series SS, nickel base alloys and heat resisting alloys. There is currently no known metal alloy that is immune to metal dusting under all conditions.

##### **4.4.5.3 Critical Factors**

- a) Process stream composition, operating temperature and alloy composition are critical factors.
- b) Metal dusting is preceded by carburization and is characterized by rapid metal wastage.
- c) Metal dusting involves a complex series of reactions involving a reducing gas such as hydrogen, methane, propane or CO.
- d) It usually occurs in the operating temperature range of 900°F to 1500°F (482°C to 816°C). Damage increases with increasing temperature.
- e) The mechanism of metal dusting is considered to be:
  - 1) Saturation of the metal matrix by carburization;
  - 2) Precipitation of metal carbides at the metal surface and grain boundaries;
  - 3) Deposition of graphite from the atmosphere onto the metal carbides at the surface;
  - 4) Decomposition of the metal carbides under the graphite and metal particles; and
  - 5) Further deposition of graphite catalyzed by the metal particles on the surface.
- f) In high nickel alloys, it is thought that metal dusting occurs without the formation of metal carbides.
- g) Metal dusting can also occur under alternating reducing and oxidizing conditions.

##### **4.4.5.4 Affected Units or Equipment**

- a) Primarily fired heater tubes, thermowells and furnace components operating in carburizing environments are affected.
- b) Metal dusting has been reported in catalytic reforming unit heater tubes, coker heaters, gas turbines, methanol reforming unit outlet piping and thermal hydrodealkylation furnaces and reactors.

##### **4.4.5.5 Appearance or Morphology of Damage**

- a) In low alloy steels, the wastage can be uniform but usually is in the form of small pits filled with a crumbly residue of metal oxides and carbides.
- b) The corrosion product is a voluminous carbon dust containing metal particles and sometimes metal oxides and carbides. Frequently, this dust will be swept away by the flowing process stream, leaving behind only the thinned or pitted metal.
- c) In stainless and high alloy steels, the attack is frequently local, appearing as deep, round pits ([Figure 4-125](#)).
- d) Metallography will show that the metal is heavily carburized under the attacked surface ([Figure 4-126](#)).

#### 4.4.5.6 *Prevention / Mitigation*

- a) Sulfur in the carburizing atmosphere (usually as H<sub>2</sub>S), forms a protective sulfide that minimizes carburization and metal dusting. It is thought that sulfur retards the carbon transfer from the atmosphere to the metal and suppresses graphite nucleation and growth. For protection, sufficient H<sub>2</sub>S must always be in the process environment. If the H<sub>2</sub>S level drops too low, even for a short period of time, damage may occur. Sulfur is a catalyst poison in some processing units so that the introduction of H<sub>2</sub>S into a process stream may not always be practical.
- b) There is currently no known metal alloy that is immune to metal dusting under all conditions. Materials selection must be made based on the specific application and environment.
- c) An aluminum diffusion treatment to the base metal substrate can be beneficial in some applications.

#### 4.4.5.7 *Inspection and Monitoring*

- a) For heater tubes with suspected damage, compression wave ultrasonic testing is probably the most efficient method of inspection since large areas can be inspected relatively quickly.
- b) RT techniques can be employed to look for pitting and wall thinning.
- c) If internal surfaces are accessible, visual inspection is effective.
- d) Filtering the cooled furnace or reactor effluent may yield metal particles that are a tell tale indication of a metal dusting problem upstream.

#### 4.4.5.8 *Related Mechanisms*

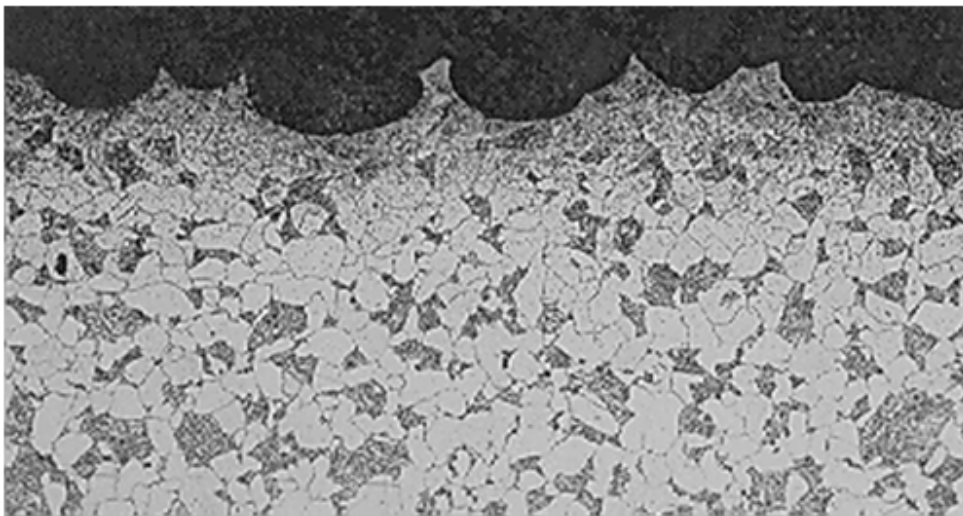
Metal dusting is also known as catastrophic carburization. Carburization is discussed in [4.4.3](#).

#### 4.4.5.9 *References*

1. H. J. Grabke, "Metal Dusting of Low- and High-Alloy Steels," CORROSION/51, 1995, p. 711.
2. H. J. Grabke, R. Krajak, and J. C. Nava Paz, "On the Mechanism of Catastrophic Carburization: Metal Dusting," Corrosion Science, Vol. 35, Nos. 5-8, 1993, p. 1141.
3. B. A. Baker and G. D. Smith, "Metal Dusting of Nickel-Containing Alloys," CORROSION/98, Paper No. 445, NACE International, Houston, TX, 1998.
4. "Corrosion Control in the Refining Industry," NACE Course Book, NACE International, Houston, TX, 1999.



**Figure 4-125 – Metal dusting of a 304H stainless steel pipe.**



**Figure 4-126 – Carbon steel separator plate in a natural gas preheater showing classical pattern of carburization and pitting**

#### 4.4.6 Fuel Ash Corrosion

##### 4.4.6.1 Description of Damage

- a) Fuel ash corrosion is accelerated high temperature wastage of materials that occurs when contaminants in the fuel form deposits and melt on the metal surfaces of fired heaters, boilers and gas turbines.
- b) Corrosion typically occurs with fuel oil or coal that is contaminated with a combination of sulfur, sodium, potassium and/or vanadium.
- c) The resulting molten salts (slags) dissolve the surface oxide and enhance the transport of oxygen to the surface to re-form the iron oxide at the expense of the tube wall or component.

##### 4.4.6.2 Affected Materials

- a) All conventional alloys used for process heater and boiler construction are susceptible.
- b) Alloys of the 50Cr-50Ni family show improved resistance.

##### 4.4.6.3 Critical Factors

- a) The concentration of molten salt forming contaminants, metal temperature and alloy composition are the critical factors.
- b) The severity of damage depends on the type of fuel (i.e., the concentrations of contaminants in the fuel), sulfur content and metal temperature.
- c) Corrosion occurs by this mechanism only if the metal temperature is above the temperature of the liquid species formed, and it is most severe where the temperatures are the highest.
- d) The corrosion rates differ depending on the alloy and location within the heater.
- e) The liquid species (slags) are different for the oil and coal ash and are also different for waterwall-tube corrosion.
  - 1) For oil ash, the liquid species are mixtures of vanadium pentoxide and sodium oxide, or vanadium pentoxide and sodium sulfate. Depending on the precise composition, melting points below 1000°F (538°C) are possible.
  - 2) For waterwall corrosion, the liquid species are mixtures of sodium and potassium pyrosulfates that have melting points as low as 700°F (371°C).
  - 3) For coal ash, superheater and reheater corrosion is caused by sodium and potassium iron trisulfates that melt between 1030°F and 1130°F (544°C and 610°C), depending on the ratio of sodium and potassium. Reducing conditions, that is, a flue gas rich in carbon monoxide, hydrogen sulfide and hydrogen will aggravate the corrosion rates.
- f) Unburned coal particles also add carbon to the fly ash deposits and provide a reducing environment on the tube surface where corrosion occurs. Carburization of the tube surface, especially on austenitic alloys will decrease corrosion resistance and increase tube wastage rates.
- g) Corrosion rates under reducing conditions may be 2 to 5 times faster than under oxidizing conditions.

##### 4.4.6.4 Affected Units or Equipment

- a) Fuel ash corrosion can occur in any fired heater or gas turbine utilizing fuels with the aforementioned contaminants.
- b) Fuel ash corrosion is most often associated with fired heaters burning vanadium and sodium contaminated fuel oils or residue.

- c) Heater tubes are sometimes not affected because their skin temperatures are cooler than the threshold melting point of the slags in most heaters. Tube hangers and supports, however, operate hotter and can suffer severe fuel ash corrosion.
- d) Some gas turbines suffer blade corrosion when switched over to burning fuel oil.
- e) In some cases, coking of the heater tubes may cause operators to increase heat flux that may push some components above the threshold temperature where fuel ash corrosion is possible.
- f) Since the melting points of these liquid species are around 1000°F (538°C) and higher in the superheaters and reheaters, any unit that has metal temperatures above the melting point of the sulfates may have the problem.
- g) For oil-fired boilers, fuel oils that do not contain vanadium are less prone to liquid ash corrosion.
- h) For waterwalls, if the temperature can be maintained below the melting point of the pyrosulfates [that is below 700°F (371°C)], damage will be minimized. Thus, steam generating pressures below about 1800 psi are nearly immune.

#### **4.4.6.5 Appearance or Morphology of Damage**

- a) Oil ash corrosion is manifested as severe metal loss associated with slagging. In some cases, corrosion rates of 100 to 1000 mpy may be experienced.
- b) Metallographic examination and deposit-analysis techniques can be used to verify the presence of fuel ash corrosion.
- c) For oil ash corrosion of superheaters and reheaters, the appearance of the ash deposit will be in at least two distinct layers. The important deposit is adjacent to the component, which will have a dark gray or black appearance at room temperature. As the liquid sulfates sinter the corrosion debris to the surface, a hard, glassy, tenacious scale is formed. When removed, the surface of the steel will have an "alligator-hide" appearance (Figure 4-127 and Figure 4-128) as shallow grooves will have penetrated the steel in a cross-hatched pattern.
- d) For waterwalls, the cracks are predominantly circumferential and, to a lesser extent, axial. The overall appearance on the waterwalls is one of circumferential grooving.
  - 1) After the liquid ash layer develops, the "slush" can only hold a certain weight of ash. When the weight is excessive, the slag is shed, exposing a bare, uninsulated tube to the heat flux of the firebox. The temperatures will spike on waterwalls, by perhaps 100°F (38°C) and the cracking is then similar to thermal fatigue.
  - 2) The mechanism for the steam-cooled tubes is similar, except that the temperature spike is probably less and, therefore, the thermal fatigue damage is less severe.
  - 3) The alligator-hide morphology of superheaters and reheaters and the circumferential cracking on waterwalls in coal-fired boilers is caused by a similar mechanism.
- e) For coal ash, the appearance will be a smooth interface between a glassy slag layer and the metal.

#### **4.4.6.6 Prevention / Mitigation**

- a) Fuel ash corrosion can be prevented by blending or changing fuel sources (minimizing the contaminants) and by operating equipment so that hot components are below the temperature where molten deposits are formed.
- b) Proper burner design and burner management can help to reduce flame impingement and localized hot spots.



- c) In some cases, the characteristics and melting points of the slags can be changed by firing with low excess oxygen or by injecting special additives into the fuel. These changes can increase the melting point of the slags and reduce the tendency of the deposits to stick to metal surfaces or dissolve the protective oxide scale. Even with changes to reduce slag formation, corrosion may continue if metal surfaces are not cleaned to remove slag and corrosion products.
- d) Corrosion of some components, such as tube hangers and supports, can be minimized by changing to a 50%Cr-50%Ni alloy, such as Alloy 657. Designs of tube hangers may need to be modified to account for the lower stress-rupture strength of the 50Cr-50Ni alloys.

#### **4.4.6.7 Inspection and Monitoring**

- a) Visual inspection is usually sufficient to detect hot ash corrosion.
- b) Metal loss is likely to be severe and the presence of a slag will be apparent.
- c) Tubes need to be grit blasted in order to remove the tenacious glass-like ash deposit. UT examination may be useful to measure loss of thickness.

#### **4.4.6.8 Related Mechanisms**

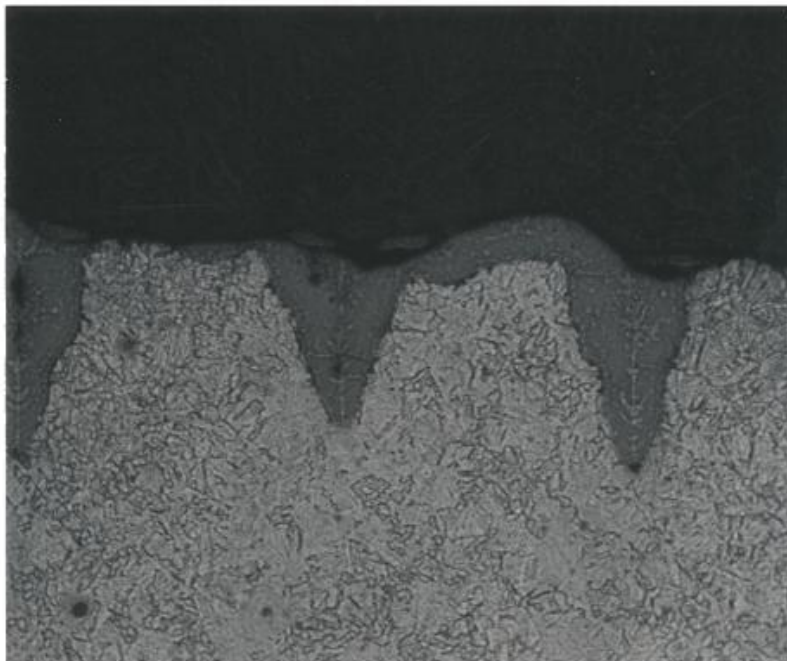
- a) Hot corrosion, hot ash corrosion, molten salt corrosion, oil ash corrosion and coal ash corrosion are all terms used to describe this mechanism.
- b) Circumferential cracking in waterwall tubes is similar to thermal fatigue aggravated by a corrosive environment ([Figure 4-129](#)).

#### **4.4.6.9 References**

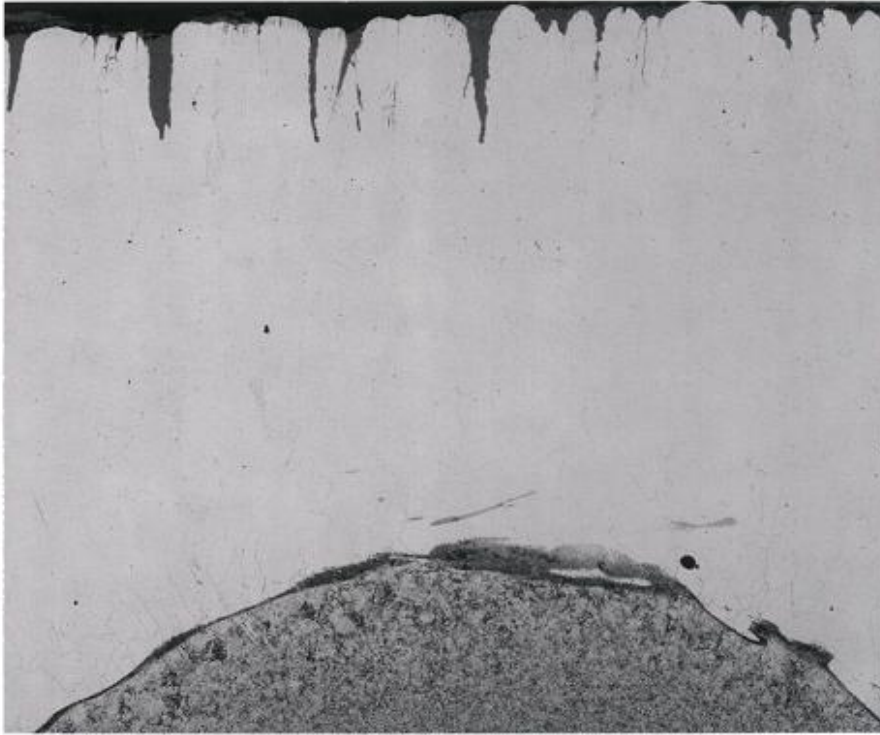
1. "Steam - Its Generation and Use," 40th Edition, Babcock and Wilcox, 1992.
2. "Combustion Fossil Power Systems," Third Edition, Combustion Engineering, Windsor, CT, 1981.
3. H. Thielsch, "Defects and Failures In Pressure Vessels and Piping," Krieger Publishing Co., NY, 1977.
4. R.D. Port and H.M. Herro, "The NALCO Guide to Boiler Failure Analysis," McGraw Hill, NY, 1991.
5. D.N. French, "Metallurgical Failures In Fossil Fired Boilers," John Wiley and Sons, Publishers, Inc., NY, 1993.
6. B. Dooley and W. Mcnaughton, "Boiler Tube Failures: Theory and Practice – 3 Volumes," EPRI, CA, 1995.



**Figure 4-127 – The “alligator hide” morphology of liquid coal-ash corrosion is evident when the dense, glassy deposit is removed. Mag. 2.4X**



**Figure 4-128 – In cross-section, the surface grooving is, in actuality, broad, V-shaped corrosion-fatigue cracks. Mag. 100X, etched.**



**Figure 4-129 – On waterwall tubes, even with a corrosion-resistant weld-overly, circumferential cracking will develop. Mag. 37½X, etched.**

## 4.4.7 Nitriding

### 4.4.7.1 Description of Damage

A hard, brittle surface layer will develop on some alloys due to exposure to high temperature process streams containing high levels of nitrogen compounds such ammonia or cyanides, particularly under reducing conditions.

### 4.4.7.2 Affected Materials

- a) Carbon steels, low alloy steels, 300 Series SS and 400 Series SS.
- b) Nickel base alloys are more resistant.

### 4.4.7.3 Critical Factors

- a) Nitriding is a diffusion controlled process dependent on temperature, time, partial pressure of nitrogen and metal composition.
- b) Temperatures must be high enough to allow for the thermal breakdown/disassociation of nitrogen from ammonia or other compounds and for diffusion of nitrogen into the metal.
- c) Nitriding begins above 600°F (316°C) and becomes severe above 900°F (482°C).
- d) High gas phase nitrogen activity (high partial pressures of nitrogen) promotes nitriding.
- e) Corrosion resistance may be adversely affected by nitriding.
- f) Alloys containing 30% to 80% nickel are more resistant.
- g) A loss of high temperature creep strength, ambient temperature mechanical properties (specifically toughness/ductility), weldability and corrosion resistance may result.

### 4.4.7.4 Affected Units or Equipment

Nitriding can occur at any location where appropriate environment and temperature conditions are met, but it is considered to be fairly rare. Nitriding has been observed in steam methane-reformers, steam gas cracking (olefin plants) and ammonia synthesis plants.

### 4.4.7.5 Appearance or Morphology of Damage

- a) Nitriding is usually confined to the surface of most components and will have a dull, dark gray appearance. However, during initial stages of nitriding, damage can only be seen with metallography as shown in [Figure 4-130](#), [Figure 4-131](#) and [Figure 4-132](#).
- b) In a more advanced stage, the material will exhibit very high surface hardness. In most cases, a slightly harder surface layer of a vessel or component will not affect the mechanical integrity of the equipment. However, the concern is for the potential development of cracks in the nitrided layer that could propagate into the base metal.
- c) Nitriding of low alloy steels containing up to 12% chromium is accompanied by an increase in volume. The nitrided layer tends to crack and flake.
- d) Above 770°F (410°C), preferential grain boundary nitriding may lead to microcracking and embrittlement.
- e) Stainless steels tend to form thin, brittle layers that may crack and spall from thermal cycling or applied stress.
- f) Nitrogen diffuses into the surface and forms needle-like particles of iron nitrides ( $\text{Fe}_3\text{N}$  or  $\text{Fe}_4\text{N}$ ) that can only be confirmed by metallography.

#### **4.4.7.6 Prevention / Mitigation**

Changing to more resistant alloys with 30% to 80% nickel is usually required. It is usually not practical to modify the process conditions to reduce the nitrogen partial pressure or to lower temperatures.

#### **4.4.7.7 Inspection and Monitoring**

- a) A change in surface color to a dull gray may indicate nitriding.
- b) Materials exposed to nitriding conditions should be inspected thoroughly because good appearance may mask damage.
- c) Hardness testing of the affected surfaces (400 to 500 BHN or higher) can help indicate nitriding.
- d) Nitrided layers are magnetic. Therefore, 300 Series SS should be checked for magnetism as an initial screening.
- e) Metallography is generally required to confirm nitriding.
- f) EC testing may be used in some cases to detect nitriding.
- g) In the advanced stages of nitriding, where cracking may have initiated, appropriate inspection techniques include PT, RT and UT.

#### **4.4.7.8 Related Mechanisms**

Similar gas-metal surface reactions occur in other environments including carburization (see [4.4.3](#)) and metal dusting (see [4.4.5](#)).

#### **4.4.7.9 References**

1. ASM Metals Handbook, "Corrosion," Volume 13, ASM International, Materials Park, OH.
2. "Corrosion Basics – An Introduction," NACE International, Houston, TX, 1984, pp. 93-94.
3. J. Scherzer and D.P. McArthur, "Test Show Effects of Nitrogen Compounds on Commercial Fluid Cat Cracking Catalysts," Oil and Gas Journal, Vol. 84, 1986, p 76-82.

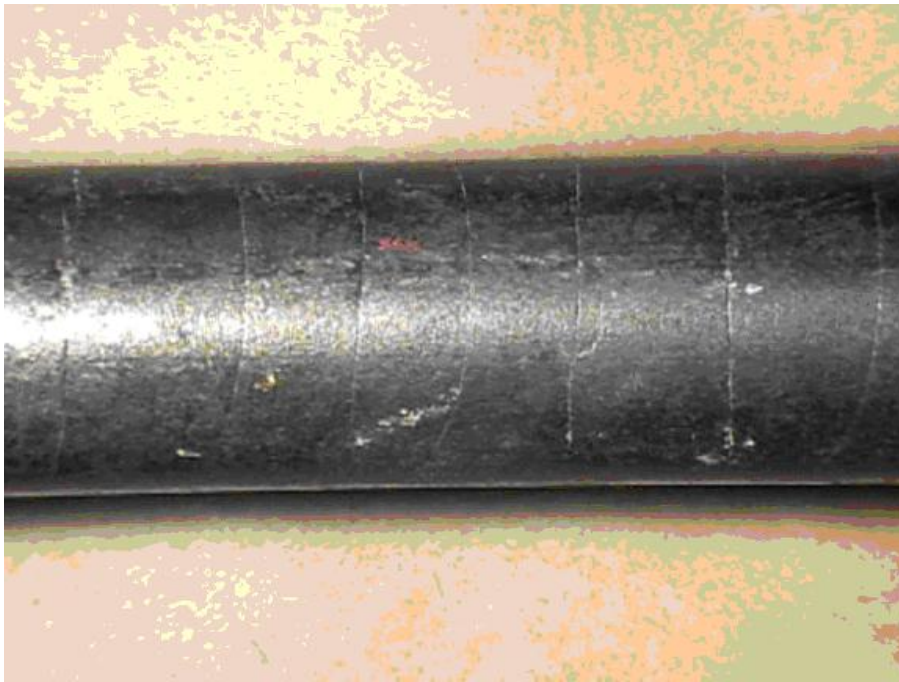


Figure 4-130 – A nitrided 5Cr-0.5Mo thermowell from an ammonia synthesis plant with surface cracking.

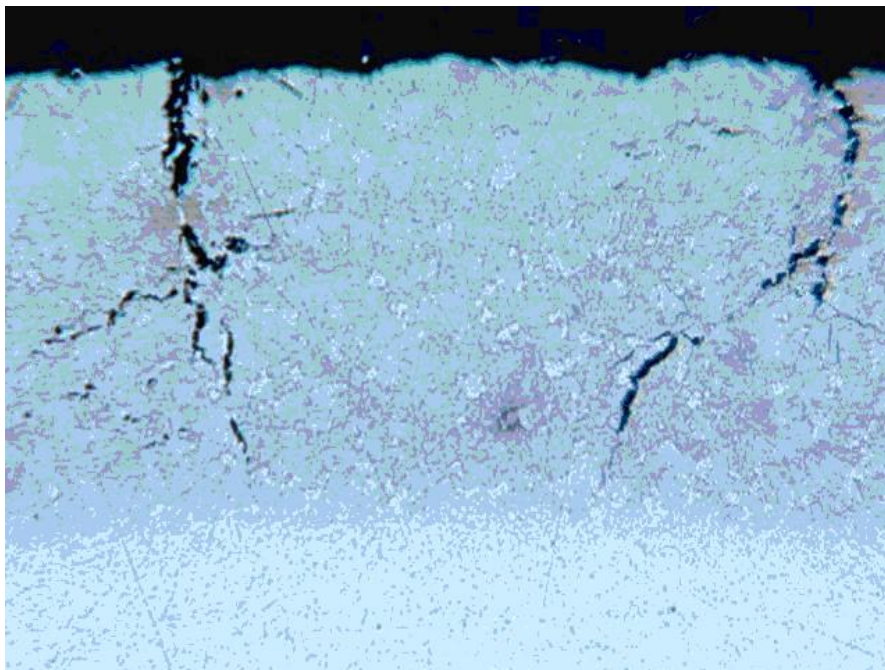
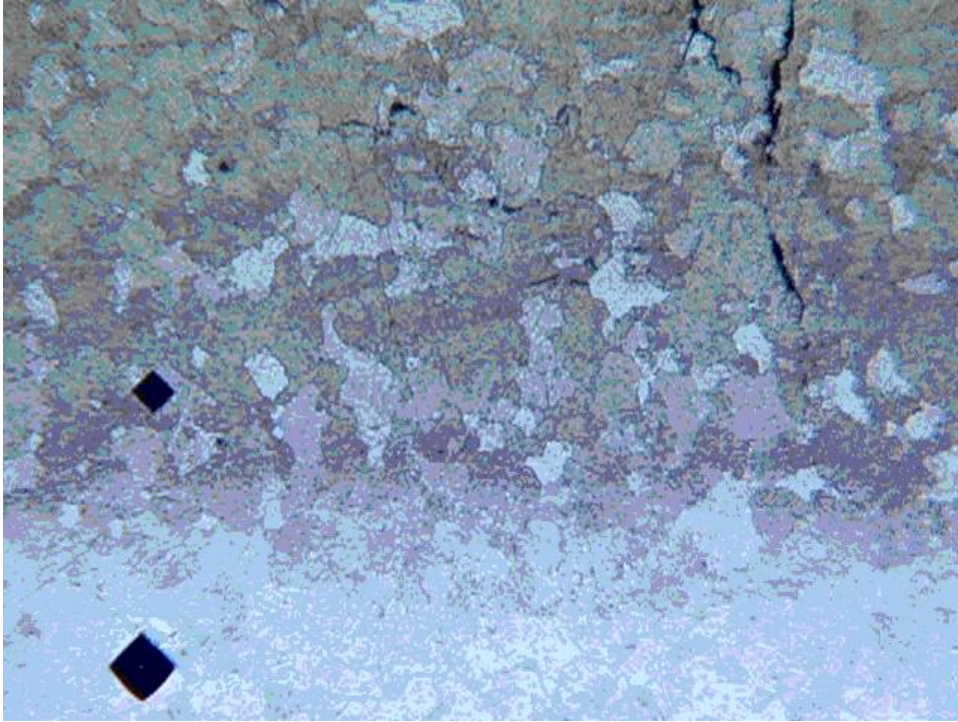


Figure 4-131 – A photomicrograph of a cross-section through the tube showing the interface between the shallow nitrided layer on the surface (gray) and the unaffected base metal (white). Cracks initiate from the O.D. surface at the top. Mag. 50X.



**Figure 4-132 – A higher magnification photomicrograph showing the diamond-shaped hardness indentations in the hard nitrided layer (540 BHN) versus the softer base metal (210 BHN). Mag. 150X.**

## 4.5 Environment – Assisted Cracking

### 4.5.1 Chloride Stress Corrosion Cracking (Cl-SCC)

#### 4.5.1.1 *Description of Damage*

Surface initiated cracks caused by environmental cracking of 300 Series SS and some nickel base alloys under the combined action of tensile stress, temperature and an aqueous chloride environment. The presence of dissolved oxygen increases propensity for cracking.

#### 4.5.1.2 *Affected Materials*

- a) All 300 Series SS are highly susceptible.
- b) Duplex stainless steels are more resistant.
- c) Nickel base alloys are highly resistant, but not immune.

#### 4.5.1.3 *Critical Factors*

- a) Chloride content, pH, temperature, stress, presence of oxygen and alloy composition are critical factors.
- b) Increasing temperatures increase the susceptibility to cracking.
- c) Increasing levels of chloride increase the likelihood of cracking.
- d) No practical lower limit for chlorides exists because there is always a potential for chlorides to concentrate.
- e) Heat transfer conditions significantly increase cracking susceptibility because they allow chlorides to concentrate. Alternate exposures to wet-dry conditions or steam and water are also conducive to cracking.
- f) SCC usually occurs at pH values above 2. At lower pH values, uniform corrosion generally predominates. SCC tendency decreases toward the alkaline pH region.
- g) Cracking usually occurs at metal temperatures above about 140°F (60°C), although exceptions can be found at lower temperatures.
- h) Stress may be applied or residual. Highly stressed or cold worked components, such as expansion bellows, are highly susceptible to cracking.
- i) Oxygen dissolved in the water normally accelerates SCC but it is not clear whether there is an oxygen concentration threshold below which chloride SCC is impossible.
- j) Nickel content of the alloy has a major affect on resistance. The greatest susceptibility is at a nickel content of 8% to 12%. Alloys with nickel contents above 35% are highly resistant and alloys above 45% are nearly immune.
- k) Low-nickel stainless steels, such as the duplex (ferrite-austenite) stainless steels, have improved resistance over the 300 Series SS but are not immune.
- l) Carbon steels, low alloy steels and 400 Series SS are not susceptible to Cl-SCC .

#### 4.5.1.4 *Affected Units or Equipment*

- a) All 300 Series SS piping and pressure vessel components in any process units are susceptible to Cl-SCC.
- b) Cracking has occurred in water-cooled condensers and in the process side of crude tower overhead condensers.



- c) Drains in hydroprocessing units are susceptible to cracking during startup/shutdown if not properly purged.
- d) Bellows and instrument tubing, particularly those associated with hydrogen recycle streams contaminated with chlorides, can be affected.
- e) External CI-SCC has also been a problem on insulated surfaces when insulation gets wet.
- f) Cracking has occurred in boiler drain lines.

#### **4.5.1.5 Appearance or Morphology of Damage**

- a) Surface breaking cracks can occur from the process side or externally under insulation (Figures 4-133 to 4-134).
- b) The material usually shows no visible signs of corrosion.
- c) Characteristic stress corrosion cracks have many branches and may be visually detectable by a craze-cracked appearance of the surface (Figure 4-135 to Figure 4-136).
- d) Metallography of cracked samples typically shows branched transgranular cracks (Figure 4-137 to 4-139).
- e) Sometimes intergranular cracking of sensitized 300 Series SS may also be seen.
- f) Welds in 300 Series SS usually contain some ferrite, producing a duplex structure that is usually more resistant to CI-SCC.
- g) Corrosion-resistant nickel-based alloys are also susceptible to cracking under severe conditions (Figure 4-140).
- h) Fracture surfaces often have a brittle appearance.

#### **4.5.1.6 Prevention / Mitigation**

- a) Use resistant materials of construction.
- b) When hydrotesting, use low chloride content water and dry out thoroughly and quickly.
- c) Properly applied coatings under insulation.
- d) Avoid designs that allow stagnant regions where chlorides can concentrate or deposit.
- e) A high temperature stress relief of 300 Series SS after fabrication may reduce residual stresses. However, consideration should be given to the possible effects of sensitization that may occur, increasing susceptibility to polythionic SCC, possible distortion problems and potential reheat cracking.

#### **4.5.1.7 Inspection and Monitoring**

- a) Cracking is surface connected and may be detected visually in some cases.
- b) PT or phase analysis EC techniques are the preferred methods.
- c) Eddy current inspection methods have also been used on condenser tubes as well as piping and pressure vessels.
- d) Extremely fine cracks may be difficult to find with PT. Special surface preparation methods, including polishing or high-pressure water blast, may be required in some cases, especially in high pressure services.
- e) UT.
- f) Often, RT is not sufficiently sensitive to detect cracks except in advanced stages where a significant network of cracks has developed.

**4.5.1.8 Related Mechanisms**

Caustic SCC (see [4.5.3](#)) and polythionic acid SCC (see [5.1.2.1](#)).

**4.5.1.9 References**

1. C.P. Dillon, "Corrosion Control in The Chemical Process Industries," Materials Technology Institute, MO, 1994, pp. 88-90.
2. "Corrosion Basics – An Introduction," NACE International, Houston, TX, 1984, pp. 111-123.



Figure 4-133 – External cracking of Type 304SS instrument tubing under insulation.



Figure 4-134 – External cracking of Type 304SS instrument tubing under insulation.



**Figure 4-135 – Cracking on the shell side of Type 316L SS tubes in steam service at 450°F (232°C), showing tubes after PT inspection. The cracks can be seen in the center tube (arrow).**



**Figure 4-136 – Close-up of the tube in Figure 4-135 showing tight cracks with a spider web appearance.**

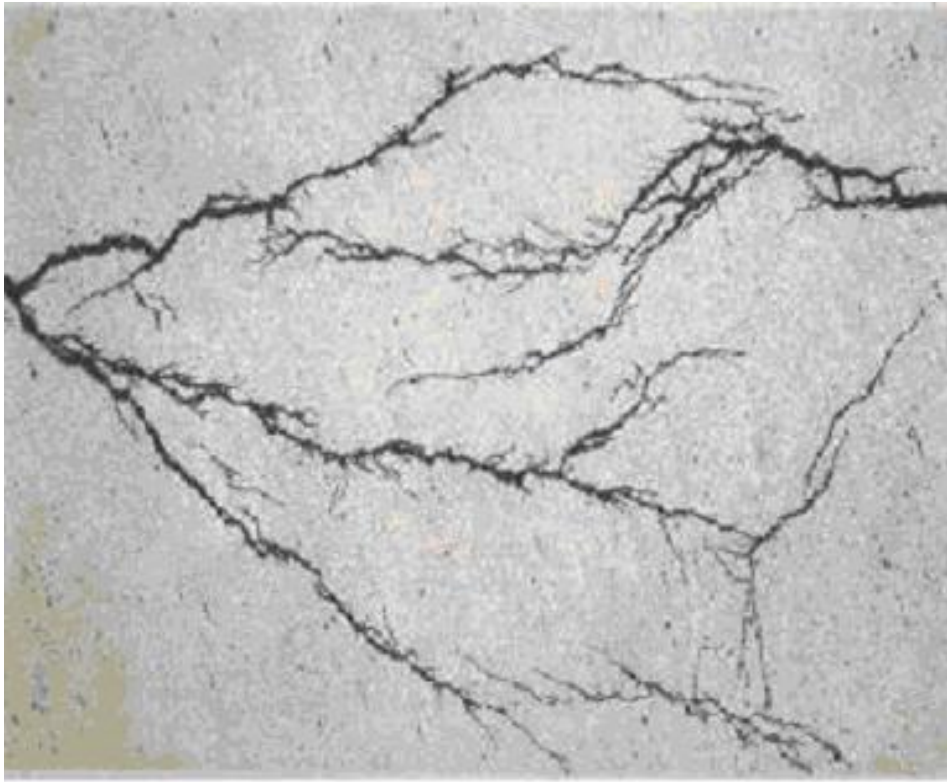


Figure 4-137 – Photomicrograph of a cross-section of sample in Figure 4-136 showing fine branching cracks. (Unetched, Mag. 50X)

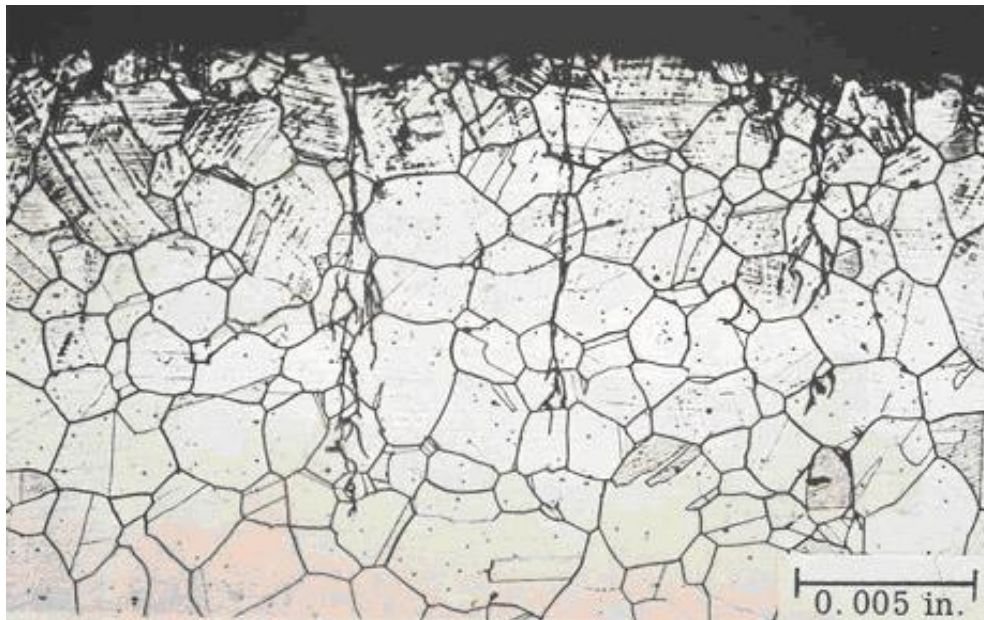
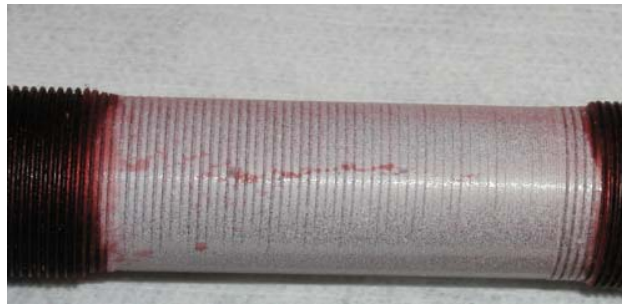


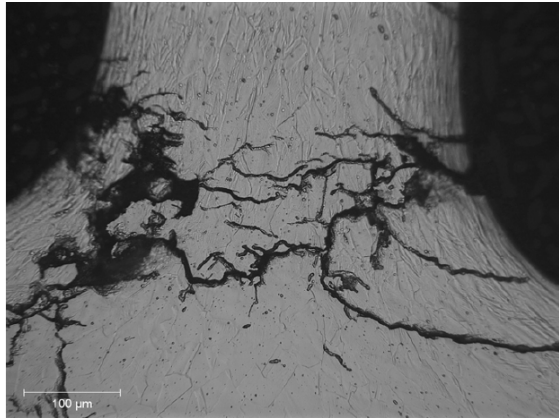
Figure 4-138 – Another photomicrograph of a cross-section of a cracked tube illustrating the transgranular mode of cracking initiating on the surface. (Etched)



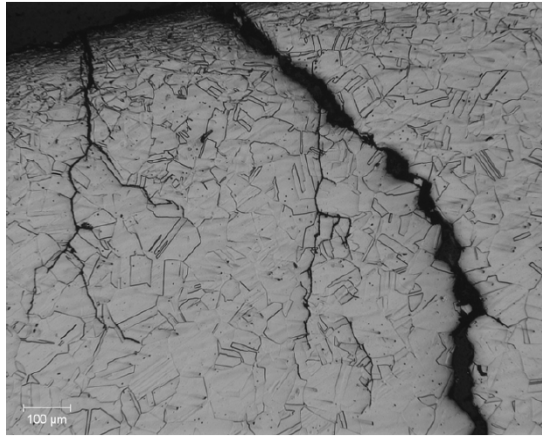
Figure 4-139 – Chloride SCC on the thread surface of a failed 303SS bolt.



a.)



b.)



c.)

**Figure 4-140 – Severe cracking of a finned Alloy C-276 tube in a Deethanizer reboiler after 8 years service due to ammonium chloride carryover. (a.) Hundreds of cracks initiated on the OD (process side) of the tube associated with the cold worked portion of the tube at the fins (b.). Branching transgranular cracks (c.)**



## 4.5.2 Corrosion Fatigue

### 4.5.2.1 *Description of Damage*

A form of fatigue cracking in which cracks develop under the combined effects of cyclic loading and corrosion. Cracking often initiates at a stress concentration such as a pit in the surface. Cracking can initiate at multiple sites.

### 4.5.2.2 *Affected Materials*

All metals and alloys.

### 4.5.2.3 *Critical Factors*

- a) The critical factors are the material, corrosive environment, cyclic stresses and stress raisers.
- b) Cracking is more likely to occur in environments that promote pitting or localized corrosion under cyclic stress due to thermal stress, vibration or differential expansion.
- c) Contrary to a pure mechanical fatigue, there is no fatigue limit load in corrosion-assisted fatigue. Corrosion promotes failure at a lower stress and number of cycles than the materials' normal endurance limit in the absence of corrosion and often results in propagation of multiple parallel cracks.
- d) Crack initiation sites include concentrators such as pits, notches, surface defects, changes in section or fillet welds.

### 4.5.2.4 *Affected Units or Equipment*

Rotating equipment, deaerators and cycling boilers, as well as any equipment subjected to cyclic stresses in a corrosive environment. Some examples include:

#### a) Rotating Equipment

Galvanic couples between the impeller and the pump shaft or other corrosion mechanisms may result in a pitting problem on the shaft. The pitting can act as a stress concentrator or stress riser to promote cracking. Most cracking is transgranular with little branching.

#### b) Deaerators

In the late 1980's, deaerators in the pulp and paper, refining and petrochemical and fossil fueled utility industries had major deaerator cracking problems. Complete vessel failures in the pulp and paper industry resulted in a diligent inspection program that found major cracking problems across the various industries. It was concluded that residual welding and fabrication stresses, stress risers (attachments and weld reinforcement) and the normal deaerator environment could produce multiple corrosion fatigue cracking problems.

#### c) Cycling Boilers

A cycling boiler may see several hundred cold starts over its useful life which, because of differential expansion, continually cracks the protective magnetite scale, allowing corrosion to continue.

**4.5.2.5 Appearance or Morphology of Damage**

- a) The fatigue fracture is brittle and the cracks are most often transgranular, as in stress-corrosion cracking, but not branched, and often results in propagation of multiple parallel cracks.
- b) Fatigue cracking will be evidenced by very little plastic deformation except that final fracture may occur by mechanical overload accompanied by plastic deformation.
- c) In cycling boilers, the damage usually appears first on the water side of buckstay (structural) attachments (Figure 4-141). The cracking pattern may be circular cracks surrounding the weld between the buckstay attachment and the waterwall tube. In cross-section, the cracks tend to be bulbous with numerous lobes (Figure 4-142). The crack tips themselves may be somewhat blunted but are oxide filled and transgranular (Figure 4-143 to 4-145).
- d) In sulfidizing environments, cracks will have a similar appearance but will be filled with a sulfide scale.
- e) In rotating equipment, most cracking is transgranular with minimal branching.

**4.5.2.6 Prevention / Mitigation**

- a) Rotating Equipment
  - 1) Modify the corrosive environment by using coatings and/or inhibitors.
  - 2) Minimize galvanic couple effects.
  - 3) Use more corrosion resistant materials.
- b) Deaerators
  - 1) Proper feedwater and condensate chemical control.
  - 2) Minimize residual welding and fabrication stresses through PWHT.
  - 3) Minimize weld reinforcement by grinding weld contours smooth.
- c) Cycling Boilers
  - 1) Start up slowly to minimize the differential expansion strains.
  - 2) Always start up with the chemistry of the boiler water under proper control.

**4.5.2.7 Inspection and Monitoring**

- a) Rotating Equipment
  - 1) UT and MT techniques can be used for crack detection.
- b) Deaerators
  - 1) Cracking is generally detected with WFMT inspection.
  - 2) Many of the cracks are very tight and difficult to detect.
- c) Cycling Boilers
  - 1) The first sign of damage is usually a pinhole leak on the cold side of a waterwall tube at a buckstay attachment.
  - 2) Inspect highly stressed regions in the boiler by UT or EMATS techniques.
  - 3) Cracking may occur at the membranes in the highly stressed regions, particularly corners at buckstays.

#### **4.5.2.8     *Related Mechanisms***

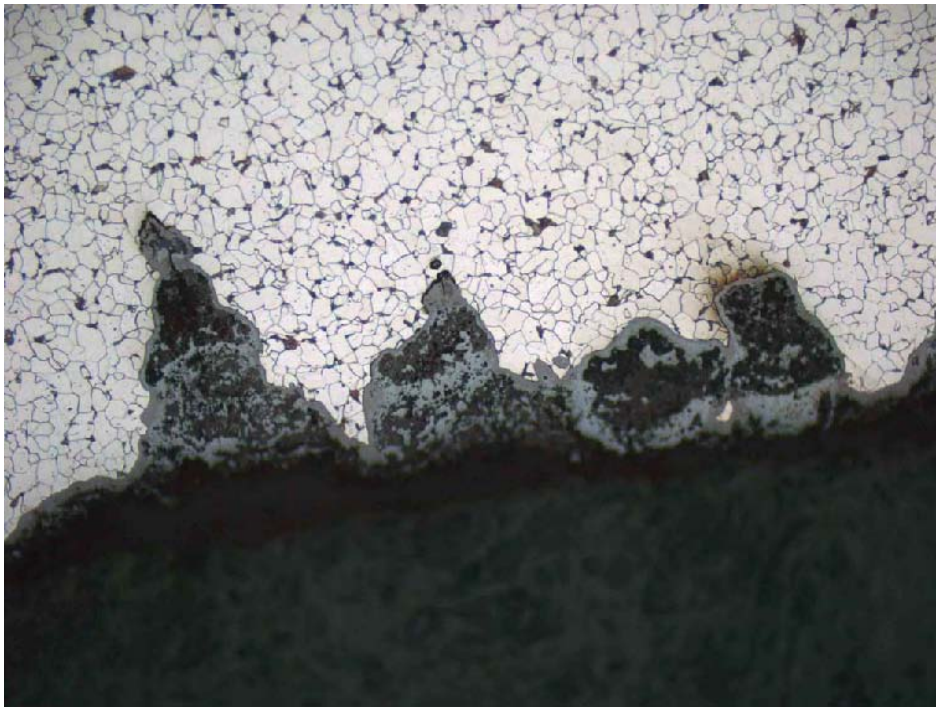
Mechanical fatigue (see [4.2.16](#)) and vibration induced fatigue (see [4.2.17](#)).

#### **4.5.2.9     *References***

1. "Steam – Its Generation and Use," 40th Edition, Babcock and Wilcox, 1992.
2. "Combustion Fossil Power Systems," Third Edition, Combustion Engineering, CT, 1981.
3. H. Thielsch, "Defects and Failures In Pressure Vessels and Piping," Krieger Publishing Co., NY, 1977.
4. R.D. Port and H.M. Herro, "The NALCO Guide To Boiler Failure Analysis," McGraw Hill, NY, 1991.
5. D.N. French, "Metallurgical Failures in Fossil Fired Boilers," John Wiley and Sons, Publishers, Inc., NY, 1993.
6. B. Dooley and W. McNaughton, "Boiler Tube Failures: Theory and Practice – 3 Volumes," EPRI, 1995.
7. ASM Metals Handbook, "Materials Characterization," Volume 10, ASM International, Materials Park, OH.
8. API 938-C, "Use of Duplex Stainless Steels in the Oil Refining Industry", American Petroleum Institute, Washington, D.C, latest edition.



**Figure 4-141 – Corrosion fatigue failure of a boiler tube.**



**Figure 4-142 – Metallographic mount of sample taken from failed boiler tube in Figure 4-141.**

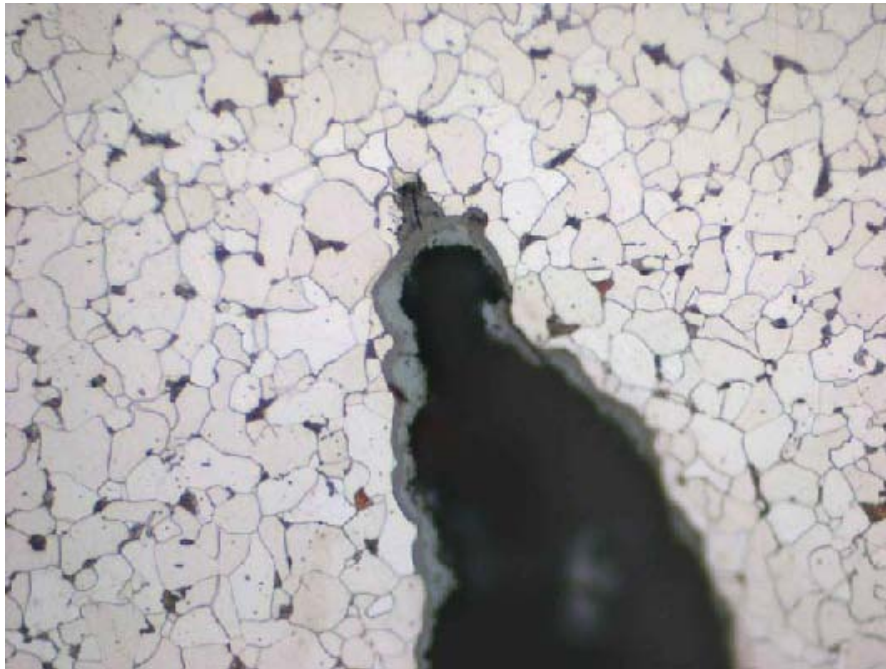


Figure 4-143 – Higher magnification view of sample shown in Figure 142.



Figure 4-144 – Photograph of a carbon steel boiler tube cut in half lengthwise. Corrosion fatigue cracks initiate at the I.D. of a tube, opposite a buckstay attachment on the O.D. (Mag. 1X)



**Figure 4-145 – Photomicrograph showing the crack morphology that is rounded with multiple lobes, and may branch to form “rabbit ears.” (Mag. 25X, etched.)**

### 4.5.3 Caustic Stress Corrosion Cracking (Caustic Embrittlement)

#### 4.5.3.1 Description of Damage

Caustic embrittlement is a form of stress corrosion cracking characterized by surface-initiated cracks that occur in piping and equipment exposed to caustic, primarily adjacent to non-PWHT'd welds.

#### 4.5.3.2 Affected Materials

Carbon steel, low alloy steels and 300 Series SS are susceptible. Nickel base alloys are more resistant.

#### 4.5.3.3 Critical Factors

- a) Susceptibility to caustic embrittlement in caustic soda (NaOH) and caustic potash (KOH) solutions is a function of caustic strength, metal temperature and stress levels.
- b) Increasing caustic concentration and increasing temperatures increase the likelihood and severity of cracking. Conditions likely to result in cracking have been established through plant experience and are presented in [Figure 4-146](#).
- c) Cracking can occur at low caustic levels if a concentrating mechanism is present. In such cases, caustic concentrations of 50 to 100 ppm are sufficient to cause cracking.
- d) Stresses that promote cracking can be residual that result from welding or from cold working (such as bending and forming) as well as applied stresses ([Figure 4-147](#) and [Figure 4-148](#)).
- e) It is generally accepted that stresses approaching yield are required for SCC so that thermal stress relief (PWHT) is effective in preventing caustic SCC ([Figure 4-146](#)). Although failures have occurred at stresses that are low relative to yield, they are considered more rare ([Figure 4-149](#) to [Figure 4-150](#)).
- f) Crack propagation rates increase dramatically with temperature and can sometimes grow through wall in a matter of hours or days during temperature excursions, especially if conditions promote caustic concentration. Concentration can occur as a result of alternating wet and dry conditions, localized hot spots or high temperature steamout.
- g) Special care must be taken with steam tracing design and steamout of non-PWHT'd carbon steel piping and equipment ([Figure 4-151](#) to [Figure 4-152](#)).

#### 4.5.3.4 Affected Units or Equipment

- a) Caustic embrittlement is often found in piping and equipment that handles caustic, including H<sub>2</sub>S and mercaptan removal units, as well as equipment that uses caustic for neutralization in sulfuric acid alkylation units and HF alkylation units. Caustic is sometimes injected into the feed to the crude tower for chloride control.
- b) Failures have occurred in improperly heat-traced piping or equipment as well as heating coils and other heat transfer equipment.
- c) Caustic embrittlement may occur in equipment as a result of steam cleaning after being in caustic service.
- d) Traces of caustic can become concentrated in BFW and can result in caustic embrittlement of boiler tubes that alternate between wet and dry conditions due to overfiring.

#### 4.5.3.5 Appearance or Morphology of Damage

- a) Caustic stress corrosion cracking typically propagates parallel to the weld in adjacent base metal but can also occur in the weld deposit or heat-affected zones.

- b) The pattern of cracking observed on the steel surface is sometimes described as a spider web of small cracks which often initiate at or interconnect with weld-related flaws that serve as local stress raisers.
- c) Cracks can be confirmed through metallographic examination as surface breaking flaws that are predominantly intergranular. The cracking typically occurs in as-welded carbon steel fabrications as a network of very fine, oxide-filled cracks.
- d) Cracking in 300 Series SS is typically transgranular and is very difficult to distinguish from chloride stress corrosion cracking (Figure 4-153).

#### **4.5.3.6 Prevention / Mitigation**

- a) Cracking can be effectively prevented by means of a stress-relieving heat treatment (e.g. PWHT). A heat treatment at 1150°F (621°C) is considered an effective stress relieving heat treatment for carbon steel. The same requirement applies to repair welds and to internal and external attachment welds.
- b) 300 Series SS offer little advantage in resistance to cracking over CS.
- c) Nickel base alloys are more resistant to cracking and may be required at higher temperatures and/or caustic concentrations.
- d) Steamout of non-PWHT'd carbon steel piping and equipment should be avoided. Equipment should be water washed before steamout. Where steamout is required, only low-pressure steam should be used for short periods of time to minimize exposure.
- e) Proper design and operation of the injection system is required to ensure that caustic is properly dispersed before entering the high-temperature crude preheat system.

#### **4.5.3.7 Inspection and Monitoring**

- a) Although cracks may be seen visually, crack detection is best performed with WFMT, EC, RT or ACFM techniques. Surface preparation by grit blasting, high pressure water blasting or other methods is usually required.
- b) PT may not be effective for finding tight, scale-filled cracks and should not be used as the only means of detection.
- c) Fine cracks may be difficult to find with RT.
- d) Crack depths can be measured with a suitable UT technique including external SWUT.
- e) AET can be used for monitoring crack growth and locating growing cracks.

#### **4.5.3.8 Related Mechanisms**

Amine cracking (see 5.1.2.2) and carbonate cracking (see 5.1.2.5) are two other similar forms of alkaline SCC.

#### **4.5.3.9 References**

1. NACE 37519, NACE Corrosion Data Survey - Metals Section, Fifth Edition, NACE International, Houston, TX.
2. "Fitness-For Service Evaluation Procedures for Operating Pressure Vessels, Tanks, and Piping in Refinery and Chemical Service," MPC Report FS-26, Draft #5, Consultants Report, Materials Properties Council, NY, 1995.
3. J.K. Nelson, "Materials of Construction for Alkalies and Hypochlorites," Process Industries Corrosion - The Theory and Practice, NACE International, Houston, TX, 1986, pp. 297-310.
4. NACE SP0403, Avoiding Caustic Stress Corrosion Cracking of Carbon Steel Refinery Equipment and Piping, NACE International, Houston, TX.



### CAUSTIC SODA SERVICE GRAPH

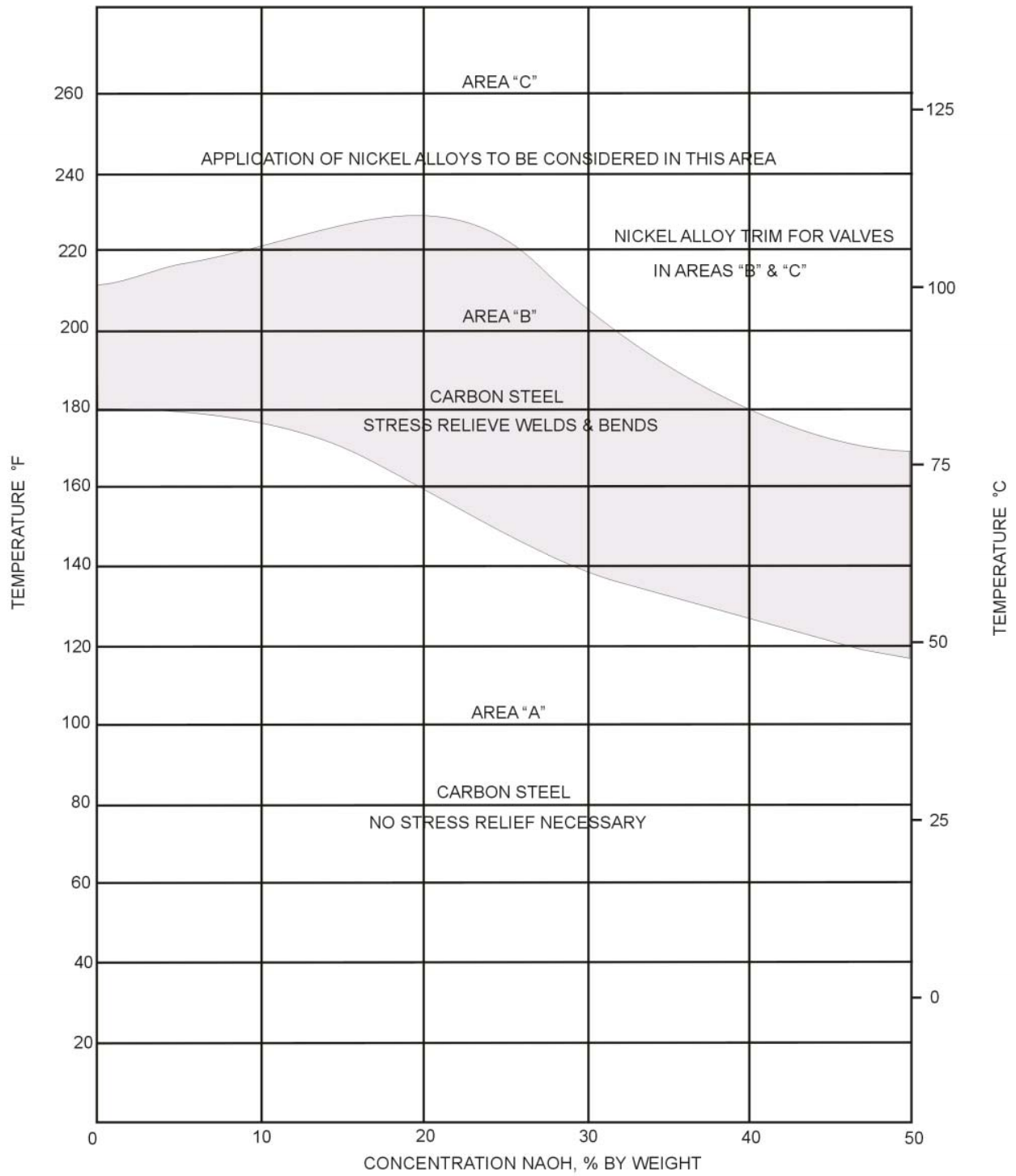
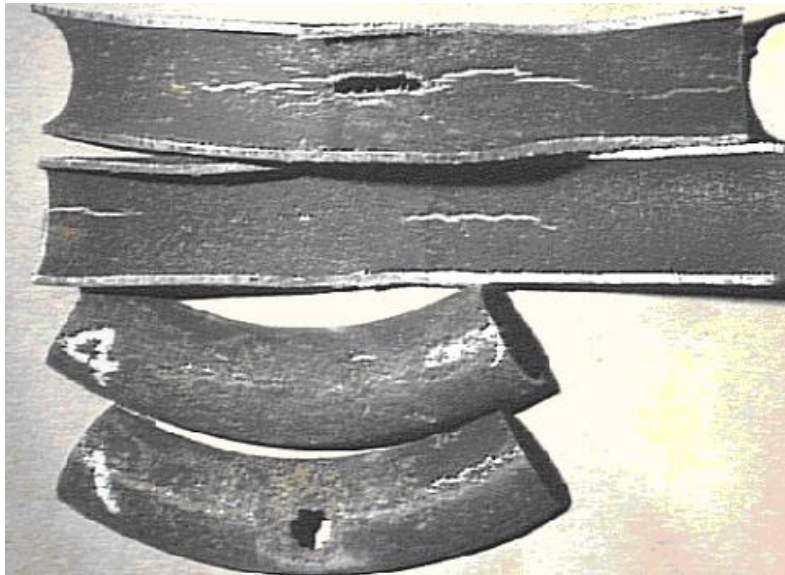


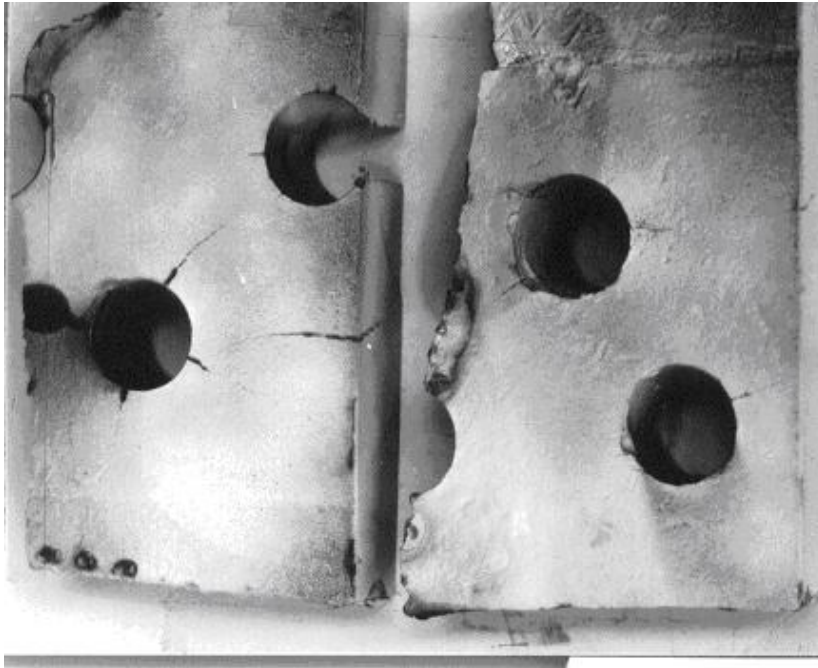
Figure 4-146 – Recommended operating limits for carbon steel in caustic service. (Reference 1)



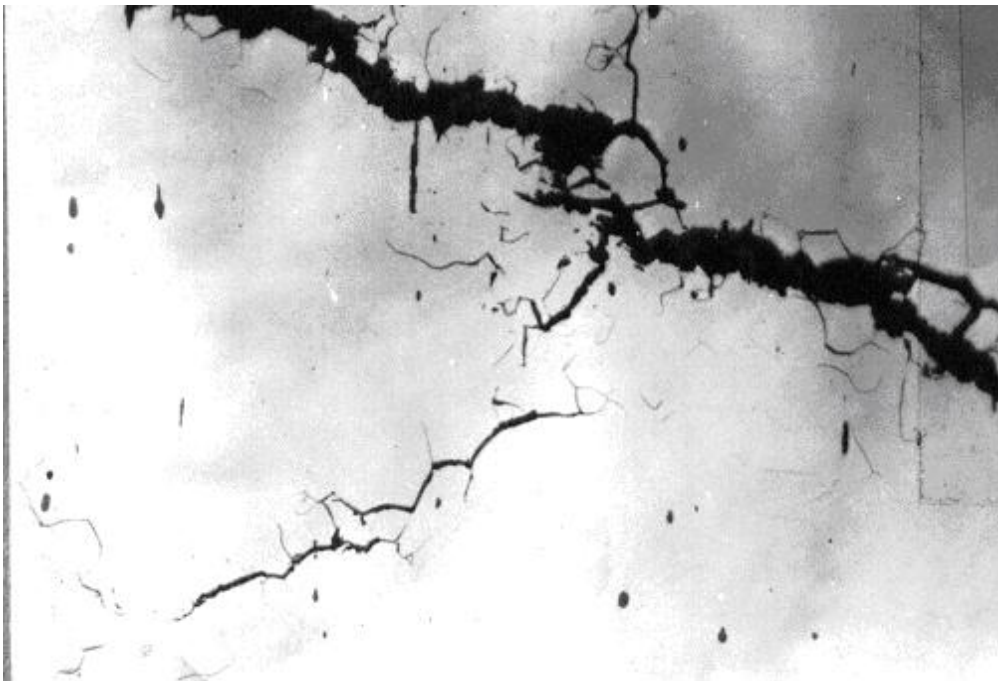
**Figure 4-147 – Cracking initiating on the inside surface of a non-stress relieved CS heat exchanger bend after 8 years in 15% to 20% caustic service at 140°F to 240°F (60°C to 115°C).**



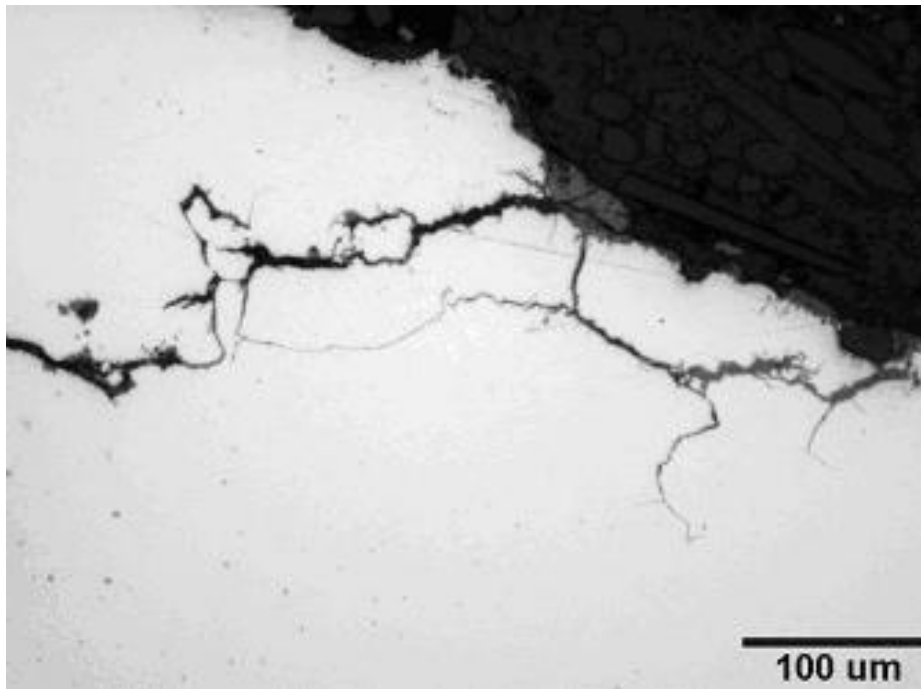
**Figure 4-148 – Photomicrograph of a crack in the tube shown in Figure 4-147.**



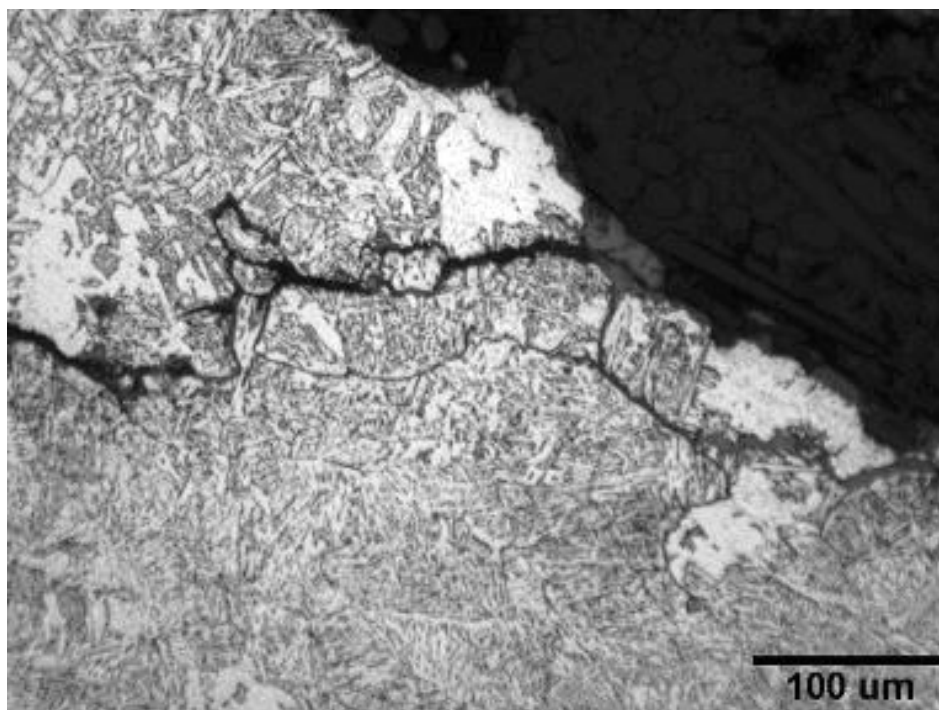
**Figure 4-149 – Cracking at a boiler tubesheet due to caustic concentrating between the tube and the tubesheet.**



**Figure 4-150 – Photomicrograph of a crack in the tubesheet shown in Figure 4-149.**



**Figure 4-151 – Photomicrograph of caustic cracking initiating on the I.D. of a carbon steel socket weld in a non-PWHT'd piping in a suction drum downstream of a caustic scrubber. Unetched.**



**Figure 4-152 – Figure 4-151 in the etched condition.**



**Figure 4-153 – Stainless steel expansion bellows from a steam-driven turbine previously subjected to a caustic carryover upset condition.**

#### **4.5.4 Ammonia Stress Corrosion Cracking**

##### **4.5.4.1 Description of Damage**

- a) Aqueous streams containing ammonia may cause Stress Corrosion Cracking (SCC) in some copper alloys.
- b) Carbon steel is susceptible to SCC in anhydrous ammonia.

##### **4.5.4.2 Affected Materials**

- a) Some copper alloys in environments with aqueous ammonia and/or ammonium compounds.
- b) Carbon steel in anhydrous ammonia.

##### **4.5.4.3 Critical Factors**

- a) For copper alloys
  - 1) Susceptible alloys may suffer cracking under the combination of residual stress and chemical compounds.
  - 2) Copper-zinc alloys (brasses), including admiralty brass and aluminum brasses, are susceptible.
  - 3) Zinc content of brasses affects susceptibility, especially as zinc increases above 15%.
  - 4) A water phase with ammonia or ammoniacal compounds must be present.
  - 5) Oxygen is necessary, but trace amounts are sufficient.
  - 6) pH above 8.5.
  - 7) Occurs at any temperature.
  - 8) Residual stresses from fabrication or tube rolling are sufficient to promote cracking.
- b) For steel
  - 1) Anhydrous ammonia with <0.2% water may cause cracking in carbon steel.
  - 2) Cracking has been reported as low as -27°F(-33°C) in laboratory testing. Crack growth rates and cracking susceptibility with increasing temperature and can occur at ambient or refrigerated conditions.
  - 3) PWHT eliminates susceptibility of most common steels (<70 ksi tensile strength).
  - 4) Contamination with air or oxygen increases tendency toward cracking.
  - 5) High residual stresses from fabrication and welding increase susceptibility.

##### **4.5.4.4 Affected Units or Equipment**

- a) Copper-zinc alloy tubes in heat exchangers.
- b) Ammonia is present as a process contaminant in some services or may be intentionally added as an acid neutralizer.
- c) Carbon steel is used for ammonia storage tanks, piping and equipment in ammonia refrigeration units as well as some lube oil refining processes.

##### **4.5.4.5 Appearance or Morphology of Damage**

- a) Copper alloys
  - 1) Surface breaking cracks may show bluish corrosion products.
  - 2) Exchanger tubes show single or highly branched cracks on the surface.

- 3) Cracking can be either transgranular (Figure 4-154 to 4-155) or intergranular (Figure 4-156), depending on the environment and stress level.
- b) For carbon steel
    - 1) Cracking will occur at exposed non-PWHT welds and heat-affected zones.
    - 2) Cracking is primarily intergranular in nature.

#### **4.5.4.6 Prevention / Mitigation**

- a) Copper alloys
  - 1) Copper-zinc alloys show improved resistance as zinc content decreases below 15%.
  - 2) The 90-10CuNi and 70-30CuNi alloys are nearly immune.
  - 3) SCC in steam service can sometimes be controlled by preventing the ingress of air.
  - 4) 300 Series SS and nickel base alloys are immune.
- b) Carbon steel
  - 1) SCC of steel can be prevented through the addition of small quantities of water to the ammonia (0.2% minimum). Consideration must be given to vapor spaces could have less than 0.2% water present due to partitioning of ammonia in water phase.
  - 2) An effective PWHT of the vessel reduces residual stress to the point where ammonia SCC can be prevented.
  - 3) Low strength steels (<70 ksi tensile strength) should be used.
  - 4) Weld hardness should not exceed 225 BHN.
  - 5) Prevent ingress of oxygen into storage facilities. Low levels of oxygen (< 10 ppm) have been reported to lead to cracking under some conditions.

#### **4.5.4.7 Inspection and Monitoring**

- a) For copper alloys
  - 1) Monitor pH and ammonia of water draw samples to assess susceptibility of copper alloys.
  - 2) Inspect heat exchanger tubes for cracking using EC or visual inspection. Rolled area is highly susceptible.
- b) For steel storage tanks and or piping in anhydrous ammonia
  - 1) WFMT welds inside tanks.
  - 2) External UT Shear wave inspection using TOFD.
  - 3) AET.

#### **4.5.4.8 Related Mechanisms**

Not applicable.

#### **4.5.4.9 References**

1. "Corrosion Basics – An Introduction," NACE International, Houston, TX, 1984, pp. 117.
2. ASM Metals Handbook, "Corrosion," Volume 13, ASM International, Materials Park, OH.
3. Cohen, "Copper and Copper-Base Alloys," Process Industries Corrosion – The Theory and Practice, NACE International, Houston, TX, 1986.

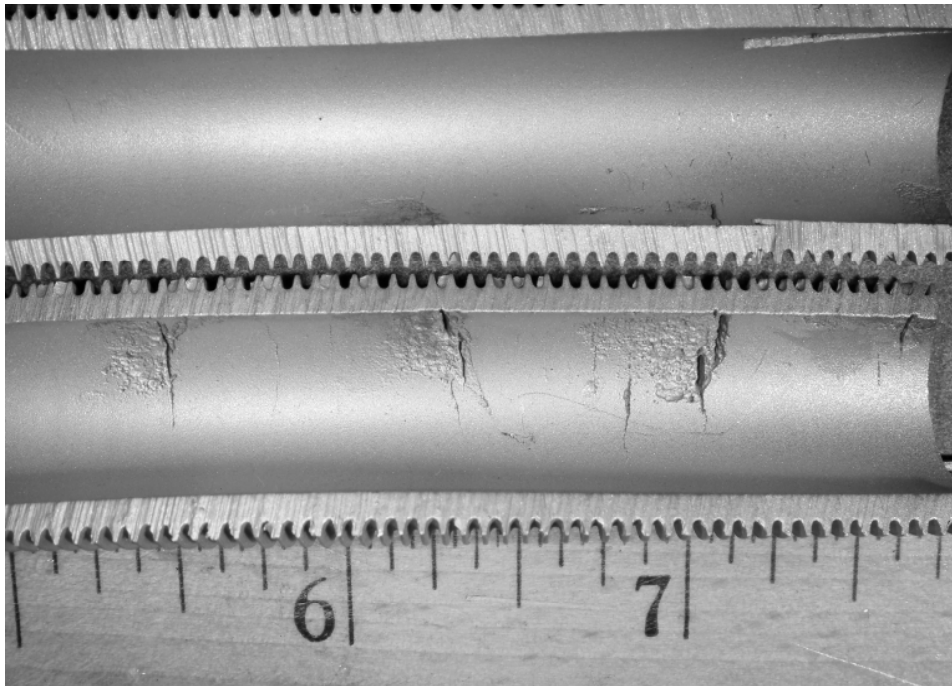


Figure 4-154 – Ammonia SCC in an inhibited admiralty tube UNS C44300, 0.75 in. diameter, BWG 16 (0.063 in. thick) with extruded fins.

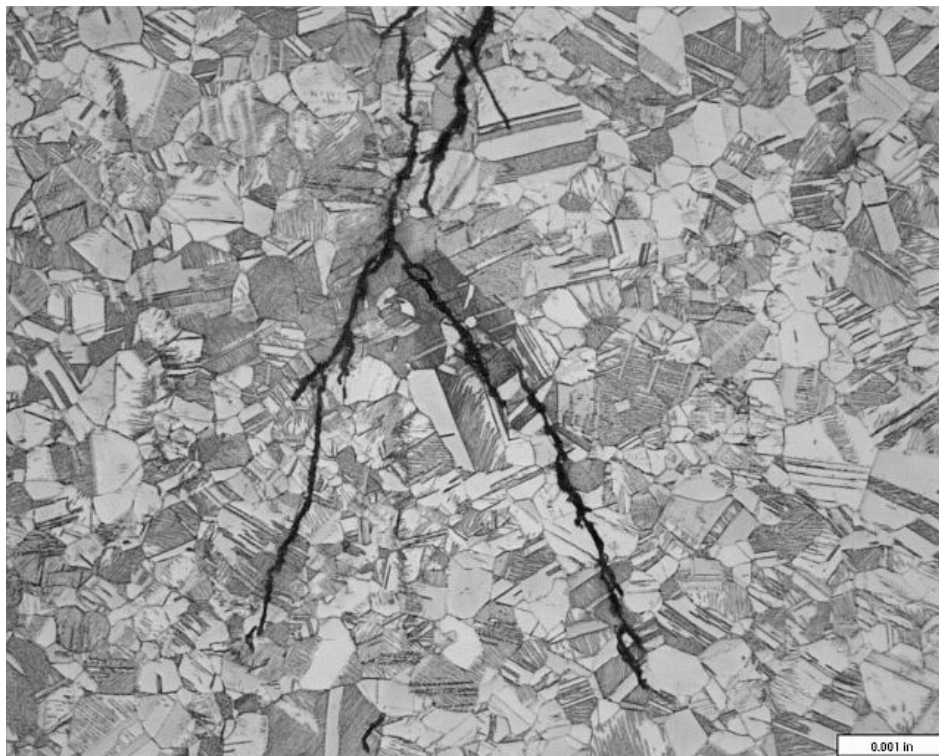
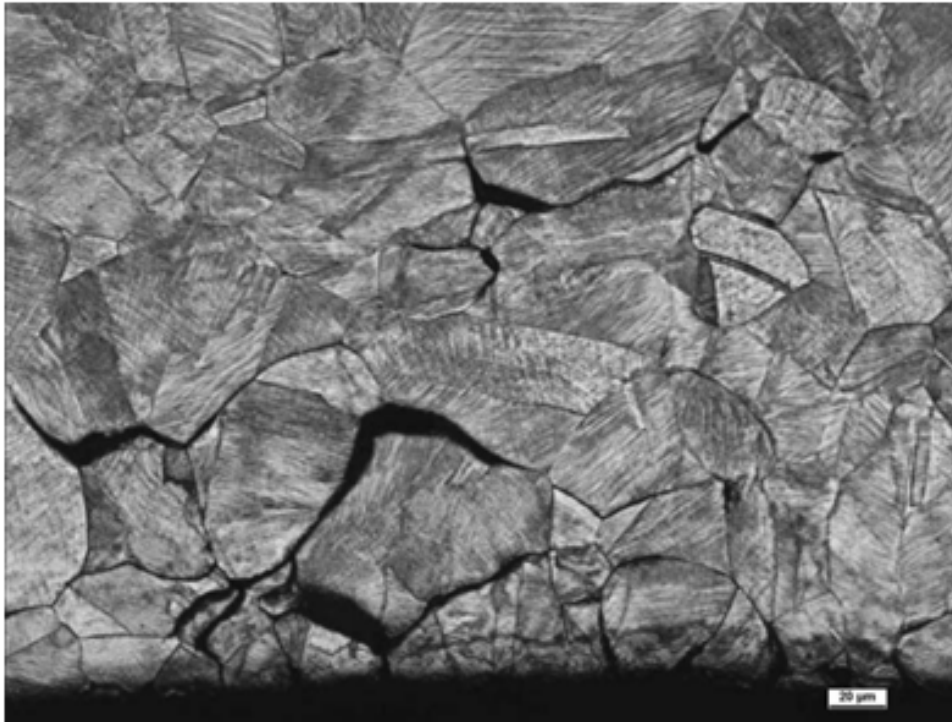


Figure 4-155 – High magnification view of a cross-section of the tube in Figure 4-154 showing transgranular cracking. (Mag. 500X)





**Figure 4-156 – High magnification view of a cross-section of a brass exchanger tube showing intergranular cracking.**

## **4.5.5 Liquid Metal Embrittlement (LME)**

### **4.5.5.1 Description of Damage**

Liquid Metal Embrittlement (LME) is a form of cracking that results when certain molten metals come in contact with specific alloys. Cracking can be very sudden and brittle in nature.

### **4.5.5.2 Affected Materials**

Many commonly used materials including carbon steel, low alloy steels, high strength steels, 300 Series SS, nickel base alloys and the copper alloys, aluminum alloys and titanium alloys.

### **4.5.5.3 Critical Factors**

- a) LME occurs in very specific combinations of metals in contact with low melting point metals such as zinc, mercury, cadmium, lead, copper and tin. Typical combinations of industrial significance are shown in [Table 4-9](#).
- b) High tensile stress promotes cracking, however, cracking can initiate simply through contacting the molten metal with the susceptible alloy. Very small quantities of the low melting point metal are sufficient to cause LME.
- c) Tensile stress contributes to crack propagation rates. Cracking under load can be extremely rapid such that cracks may pass through the wall within seconds of contact with the molten metal.
- d) Cracking can occur after long periods of time when contaminated surfaces are exposed to liquid metals.
- e) A susceptible metal in contact with a low melting metal at low temperatures may crack later when the temperature rises above the melting temperature of the low melting alloy.

### **4.5.5.4 Affected Units or Equipment**

- a) During a fire, molten metals may drip onto or contact a susceptible metal. Examples include melted zinc galvanizing, cadmium electrical housings, tin or lead from solders, and melted copper components.
- b) LME can occur in any location where the LME couples are found. A common example is 300 Series SS piping or vessels in contact with (or previously rubbed against) galvanized steel ([Figure 4-157](#) and [Figure 4-158](#)).
- c) In refineries, mercury is found in some crude oils and can condense in the atmospheric tower overhead system thereby embrittling brass, Alloy 400, titanium or aluminum exchanger components.
- d) Failure of process instruments that utilize mercury can introduce the liquid metal into refinery streams ([Figure 4-159](#)).
- e) LME of aluminum components has occurred in LNG facilities and cryogenic gas plant components due to condensation of liquid mercury.

### **4.5.5.5 Appearance or Morphology of Damage**

- a) Damage resulting from LME will appear as brittle cracks in an otherwise ductile material. LME can only be confirmed through metallography by the presence of intergranular cracks, usually filled with the low melting metal.
- b) Techniques such as spectrographic analysis may be required to confirm the presence of the molten metal species.

**4.5.5.6 Prevention / Mitigation**

- a) LME can only be prevented by protecting metal substrates from coming into contact with the low melting metal. For example, galvanized steel components should not be welded to 300 Series SS. 300 Series SS should be protected to avoid contact with galvanized components and overspray from zinc and inorganic zinc coatings.
- b) Once cracking from LME has initiated, grinding out the affected area is not an acceptable fix.

**4.5.5.7 Inspection and Monitoring**

- a) Cracks can be detected with MT examination for ferritic steel and PT examination for 300 Series SS and nickel base alloys.
- b) Because of the high density of mercury, radiography has been used to locate deposits inside heat exchanger tubes.

**4.5.5.8 Related Mechanisms**

- a) LME is also referred to as Liquid Metal Cracking (LMC).
- b) Nickel alloys are susceptible to a similar mechanism caused by the nickel-nickel sulfide eutectic that forms at 1157°F (625°C).

**4.5.5.9 References**

1. ASM Metals Handbook, "Failure Analysis and Prevention," Volume 11, ASM International, Materials Park, OH.
2. C.P. Dillon, "Corrosion Control in The Chemical Process Industries," Materials Technology Institute, MO, 1994, pp. 84 –85.

**Table 4-9 – Some LME Couples Susceptible to Embrittlement. (Reference 1)**

<b>Susceptible Alloy</b>	<b>Molten Metal</b>
300 Series SS	Zinc
Copper Alloys	Mercury
Alloy 400	Mercury
Aluminum Alloys	Mercury
High Strength Steels	Cadmium, Lead

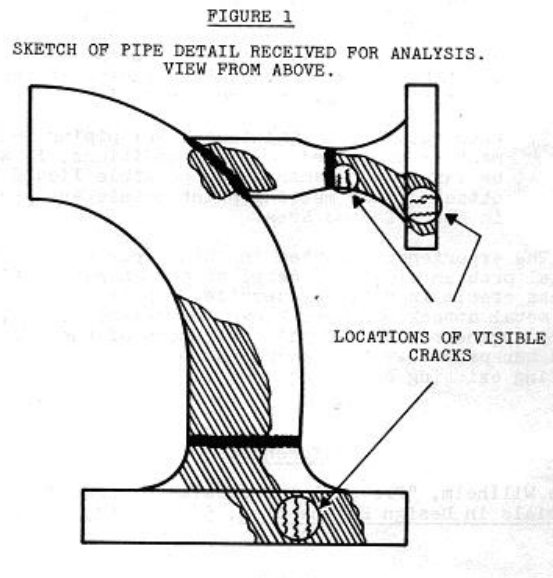


Figure 4-157 – Sketch of a stainless steel elbow that suffered liquid metal embrittlement as a result of dripping molten zinc during a fire.

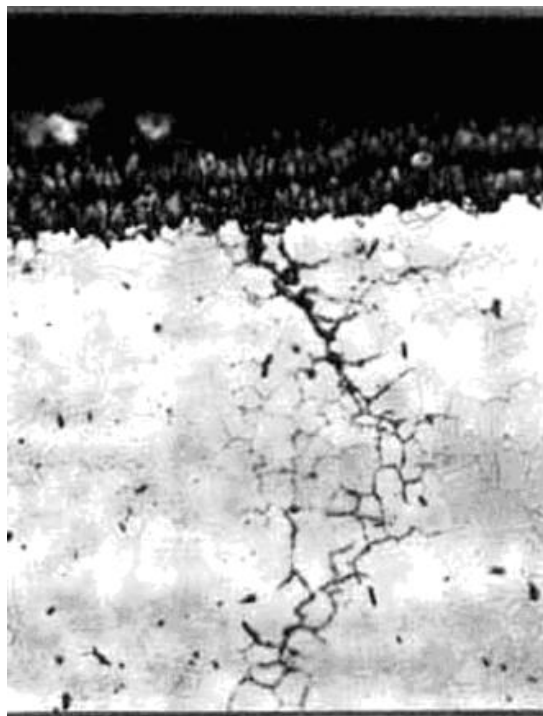


Figure 4-158 – Photomicrograph of a section of the elbow in Figure 4-157, illustrating the intergranular nature of zinc-filled cracks in stainless steel.



**Figure 4-159 – Liquid metal embrittlement of Monel caused by mercury in an FCC gas plant overhead drum.**

## 4.5.6 Hydrogen Embrittlement (HE)

### 4.5.6.1 Description of Damage

A loss in ductility of high strength steels due to the penetration of atomic hydrogen can lead to brittle cracking. Hydrogen Embrittlement (HE) can occur during manufacturing, welding, or from services that can charge hydrogen into the steel in an aqueous, corrosive, or a gaseous environment.

### 4.5.6.2 Affected Materials

Carbon steel and low alloy steels, 400 Series SS, Precipitation Hardenable (PH) SS and some high strength nickel base alloys.

### 4.5.6.3 Critical Factors

- a) Three conditions must be satisfied:
  - 1) Hydrogen must be present at a critical concentration within the steel/alloy.
  - 2) The strength level and microstructure of the steel/alloy must be susceptible to embrittlement.
  - 3) A stress above the threshold for HE must be present from residual stresses and/or applied stresses.
- b) The hydrogen can come from:
  - 1) Welding – if wet electrodes or high moisture content flux weld electrodes are used, hydrogen can be charged into the steel (delayed cracking).
  - 2) Cleaning and pickling in acid solutions.
  - 3) Service in high temperature hydrogen gas atmospheres, molecular hydrogen dissociates to form atomic hydrogen that can diffuse into the steel.
  - 4) Wet H<sub>2</sub>S services or HF acid services in which atomic hydrogen diffuses into the steel. (Cyanides, arsenic and FeS can act as hydrogen recombination poisons that diminish the hydrogen gas reaction and allows for greater charging rates.)
  - 5) Manufacturing – melting practices or manufacturing processes particularly where components are plated (hydrogen flaking).
  - 6) Cathodic protection.
- c) The effect is pronounced at temperatures from ambient to about 300°F (149°C). Effects decrease with increasing temperature.
- d) HE affects static properties to a much greater extent than impact properties. If the hydrogen is present and a sufficient stress is applied, failure can occur quickly.
- e) The amount of trapped hydrogen depends on the environment, surface reactions and the presence of hydrogen traps in the metal such as imperfections, inclusions and pre-existing flaws or cracks.
- f) The amount of hydrogen needed to have a measurable effect on the mechanical properties varies with the strength level, microstructure and heat treatment for the alloy. In some cases, thresholds of critical hydrogen concentrations have been established.
- g) Stresses include cooling during manufacture, residual stresses from welding or applied loads.
- h) Thick wall components are more vulnerable due to increased thermal stress and high restraint and take longer for hydrogen to diffuse out.
- i) In general, as strength increases, susceptibility to HE increases. Certain microstructures, such as untempered martensite and pearlite, are more susceptible at the same strength level than tempered martensite. Carbon steel that is severely hydrogen charged will have lower toughness than with no hydrogen.

**4.5.6.4 Affected Units or Equipment**

- a) Services where HE is a concern include carbon steel piping and vessels in wet H<sub>2</sub>S services in FCC, hydroprocessing, amine, sour water services and HF alkylation units. However, mild steel used for vessels and piping in most refining, fossil utility and process applications have low hardness and are usually not susceptible to HE except at weldments, particularly the HAZ, if suitable PWHT is not performed.
- b) Storage spheres are often made of slightly higher strength steels and are more susceptible than most other refinery equipment.
- c) Bolts and springs made of high strength steel are very prone to HE. (Alloys that have a tensile strength above 150 ksi can absorb hydrogen during electroplating and crack.)
- d) Cr-Mo reactors, drums and exchanger shells on hydroprocessing units and catalytic reforming units are susceptible if the weld heat-affected zone hardness exceeds 235 BHN.

**4.5.6.5 Appearance or Morphology of Damage**

- a) Cracking due to HE can initiate sub-surface, but in most cases is surface breaking ([Figure 4-160 to 4-161](#)).
- b) HE occurs at locations of high residual or tri-axial stresses (notches, restraint) and where the microstructure is conducive, such as in weld HAZ's.
- c) On a macro-scale, there is often little evidence, although some materials will appear to have brittle fracture surfaces. On a microscale, the material will contain less ductile fracture surface, but must often be compared to a fracture without the presence of hydrogen.
- d) In higher strength steels, cracking is often intergranular.

**4.5.6.6 Prevention / Mitigation**

- a) Dependent on the source of the hydrogen, alloy composition and fabrication/heat treatment history.
- b) Use lower strength steels and PWHT to temper the microstructure, improve ductility and reduce residual stresses and hardness.
- c) During welding, use low hydrogen, dry electrodes and preheating methods. If hydrogen is expected to have diffused into the metal, an elevated temperature bake out [400°F or higher (204°C or higher)] may be required to drive the hydrogen out prior to welding.
- d) Heavy wall equipment in hot hydrogen service requires controlled shutdown and start-up procedures to control the pressurization sequence as a function of temperature.
- e) In corrosive aqueous services, apply a protective lining, SS cladding or weld overlay to prevent the surface hydrogen reactions.

**4.5.6.7 Inspection and Monitoring**

- a) For surface cracking inspection use PT, MT or WFMT.
- b) UT may also be useful in finding HE cracks.
- c) RT often is not sufficiently sensitive to detect HE cracks.
- d) If the source of hydrogen is a low temperature aqueous environment, hydrogen flux can be monitored using specialized instruments.

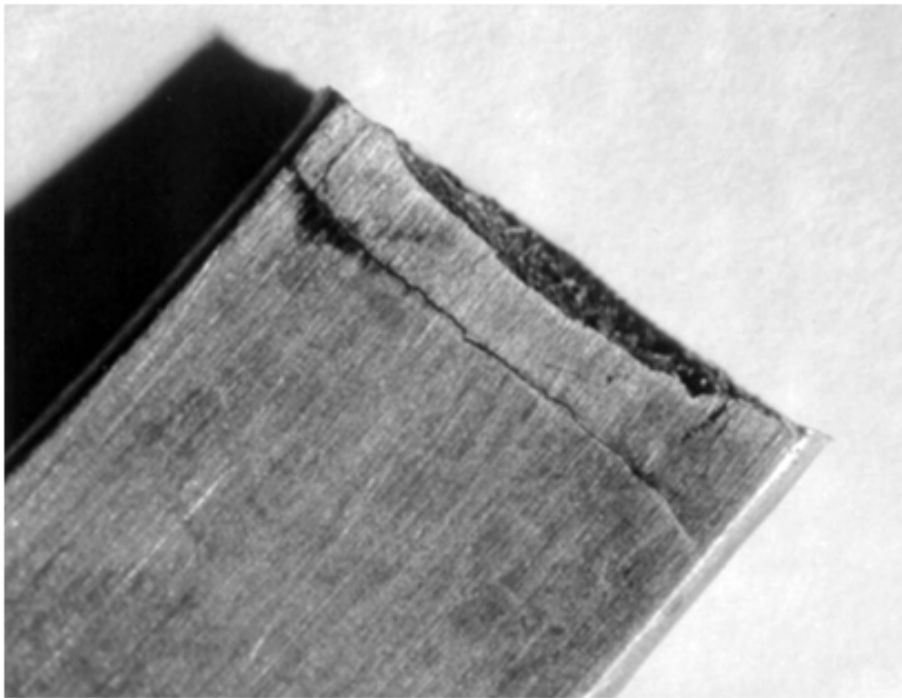
**4.5.6.8 Related Mechanisms**

Also known as hydrogen flaking, underbead cracking, delayed cracking, hydrogen assisted cracking, hydrogen induced cracking. Sulfide stress cracking (see [5.1.2.3](#)) and hydrogen stress corrosion cracking in HF (see [5.1.2.4](#)) are closely related forms of hydrogen embrittlement.



**4.5.6.9   References**

1. W.E. Erwin and J.G. Kerr, , "The Use of Quenched and Tempered 2-1/4Cr-1Mo Steel for Thick Wall Reactor Vessels in Petroleum Refinery Processes: An Interpretive Review of 25 Years of Research and Application," WRC Bulletin No.275, Welding Research Council, Shaker Heights, OH.
2. R.S. Treseder, "Guarding Against Hydrogen Embrittlement, " Chemical Engineering Magazine, June 1981, Chemical Week Publishing, NY, 1981.
3. ASM Metals Handbook, "Corrosion," Volume 13, ASM International, Materials Park, OH.
4. "Corrosion Basics – An Introduction," NACE International, Houston, TX, 1984, pp. 120-121.



a.)

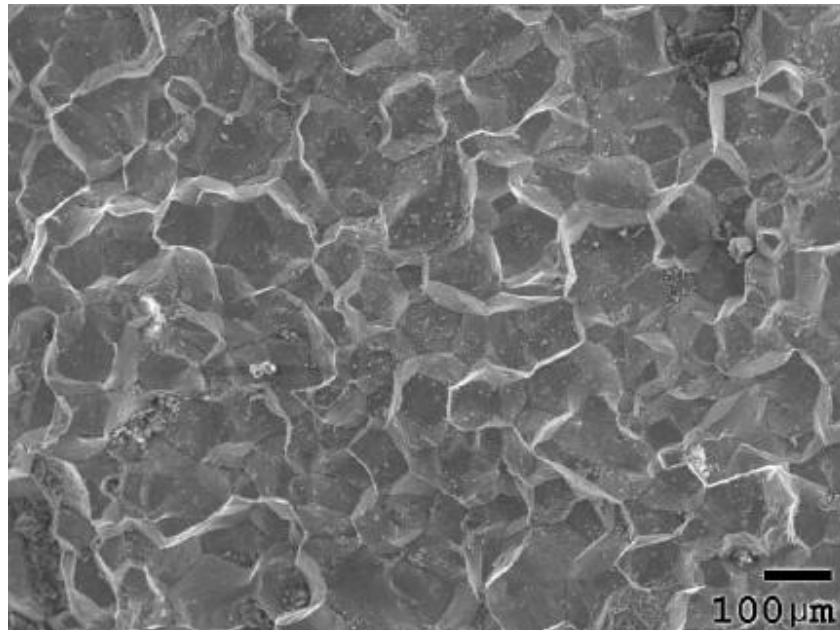


b.)

Figure 4-160 – a.) Cracking due to hydrogen embrittlement of a carbon steel tube. b.) Intergranular crack emanating from surface in the tube.



a.)



b.)

**Figure 4-161 – a.) Hydrogen Embrittlement of Martensitic SS Pump Parts. b.) High magnification photomicrograph of fracture surface showing intergranular nature of cracking.**

## **4.5.7 Ethanol Stress Corrosion Cracking (SCC)**

### **4.5.7.1 Description of Damage**

Surface-initiated cracks caused by environmental cracking of carbon steel under the combined action of tensile stress and a fuel grade ethanol (FGE, ASTM D 4806) or FGE / gasoline blend environment. Dissolved oxygen and the presence of variable stresses such as cyclic stress or component flexing, increase the propensity for cracking.

### **4.5.7.2 Affected Materials**

- a) All grades of carbon steel are susceptible.
- b) Ethanol SCC has not been reported in materials other than carbon steel, but general corrosion may be a concern with other materials including some alloys of aluminum, copper and copper alloys, lead and zinc.
- c) FGE and blends with gasoline may adversely affect non-metallic materials (e.g. coatings and seals) causing swelling, hardness changes, etc.

### **4.5.7.3 Critical Factors**

- a) Several factors have been identified by field observations.
  - 1) Stress may be applied or residual. Highly stressed, locally cold worked components, or components with stress concentrators are susceptible to cracking. Variable stresses, such as those produced by loading and unloading of tanks, have led to cracking in tank bottoms and floating roofs.
  - 2) Cracking has been found to occur in FGE meeting ASTM D 4806 specifications, including the water content requirement.
  - 3) Corrosion inhibitors may be added to ethanol to prevent general corrosion in vehicle fuel systems, but their affect on SCC is not fully understood.
- b) Other factors have been identified in controlled laboratory conditions using conservative Slow Strain Rate Test (SSRT) methods which stress the steel sample to failure. Evidence of SCC is based on the stress / strain behavior and an examination of the fracture surfaces.
  - 1) Aeration (i.e. the dissolved oxygen content) of the ethanol appears to be the most important factor for determining ethanol SCC susceptibility. Cracking has not been found under deaerated conditions.
  - 2) The maximum potential for ethanol SCC occurs within a narrow range of water content between 0.1 and 4.5 vol%.
  - 3) Ethanol SCC has been found to occur in blends of FGE and gasoline containing as little as 20 vol% FGE.
  - 4) Galvanic coupling of a new steel to corroded steel increases the likelihood of ethanol SCC.
  - 5) Increasing the chloride content of the ethanol tends to increase the severity of cracking and changes the crack type from mainly intergranular found in the field to transgranular cracking.

### **4.5.7.4 Affected Units or Equipment**

- a) Carbon steel storage tanks, rack piping, and associated equipment are susceptible to ethanol SCC. All grades of carbon steel are susceptible
- b) Cracking has also been reported in a pipeline used to transport FGE to and from a terminal.
- c) Ethanol SCC has not been reported in FGE manufacturers' equipment and tankage, or in transportation equipment (barges, trucks, railcars).

- d) Cracking has not been reported in equipment handling FGE after it has been blended with gasoline at end-use concentrations in unleaded gasoline (10 vol%). There has been one reported failure of an end-user E-85 tank.

#### **4.5.7.5 Appearance or Morphology of Damage**

- a) Ethanol SCC is often found in the vicinity of welds and can appear as cracks that are parallel to the weld or transverse to the weld (Figures 4-162 to 4-169).
- b) Cracks are typically tight and may be filled with corrosion product.
- c) Ethanol SCC cracks are typically branched and intergranular, but transgranular or mixed-mode cracking has also been reported. Field failures tend to be intergranular, while laboratory testing has produced all crack morphologies. The cracking mode appears to depend on the chloride level, with an increased chloride content tending to shift the cracking from intergranular to transgranular or mixed mode.
- d) Microstructure of materials subjected to ethanol SCC are typically ferrite, or ferrite and pearlite.

#### **4.5.7.6 Prevention / Mitigation**

- a) The likelihood of ethanol SCC can be reduced though PWHT (when possible) or by applying coatings. Given the high threshold stress intensities required to initiate ethanol SCC, standard carbon steel PWHT is expected to be effective. Research to confirm this is currently under way.
- b) Avoid designs with highly localized tensile stresses.
- c) Avoid the usage of lap seam welds that may concentrate strain in components.
- d) Minimize cold working during fabrication.

#### **4.5.7.7 Inspection and Monitoring**

- a) It is difficult to visually detect ethanol SCC because the cracks are typically tight and filled with corrosion product. Some small leaks may occur before an ethanol crack can be visually detected.
- b) WFMT is the preferred method for detecting ethanol cracking. Methods for ethanol SCC inspection are similar to those used for detecting other types of SCC.
- c) Shear wave UT may be used in instances where WFMT is not feasible.
- d) ACFM can be used with less surface preparation than WFMT in areas such as weld HAZ's.
- e) EC is unproven as a method for detection of ethanol SCC.

#### **4.5.7.8 Related Mechanisms**

Ethanol SCC is assumed to be similar to other reported in methanol and various alkaline aqueous solutions..

#### **4.5.7.9 References**

1. API Technical Report 939-D, Stress Corrosion Cracking of Carbon Steel in Fuel-Grade Ethanol: Review, Experience Survey, Field Monitoring, and Laboratory Testing, Second Edition, May 2007, American Petroleum Institute, Washington, D.C.
2. API Bulletin 939E, Identification, Repair, and Mitigation of Cracking of Steel Equipment in Fuel Ethanol Service, First Edition, November 2008, American Petroleum Institute, Washington, D.C.
3. ASTM D 4806, Standard Specification for Denatured Fuel Ethanol for Blending with Gasolines for Use as Automotive Spark-Ignition Engine Fuel, ASTM International, West Conshohocken, PA.

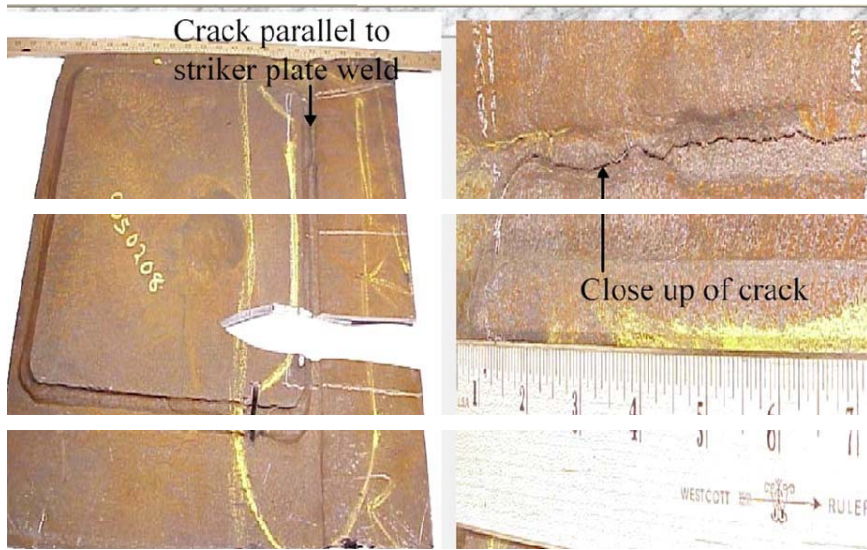


Figure 4-162 – Ethanol SCC in steel tank bottom. Note crack running parallel to fillet weld in striker plate.

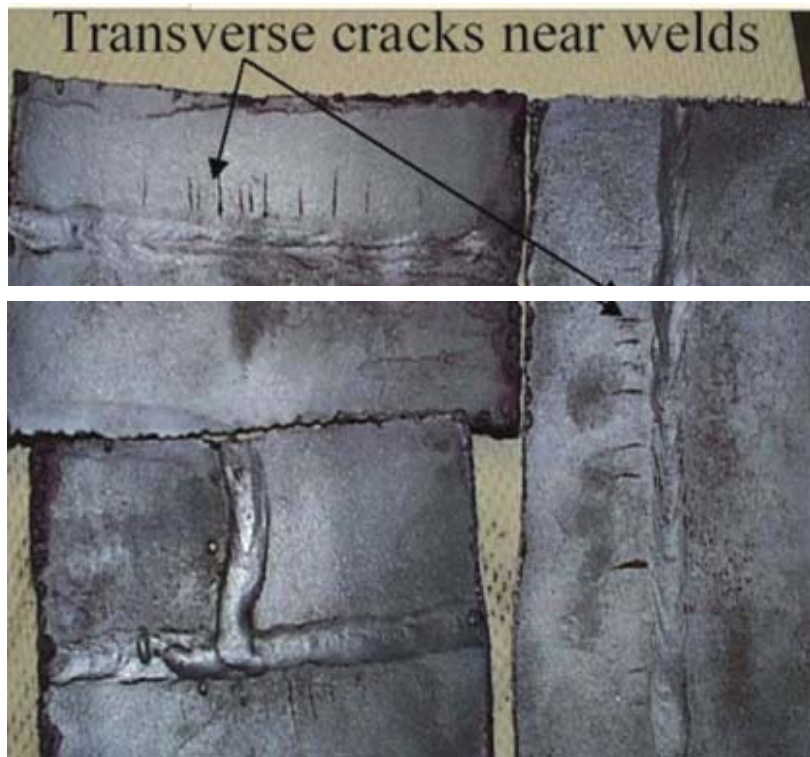


Figure 4-163 – Ethanol SCC in a steel air eliminator vessel. Note cracks running perpendicular to the weld.



Figure 4-164 – A leak in piping resulting from an ethanol SCC adjacent to the weld.

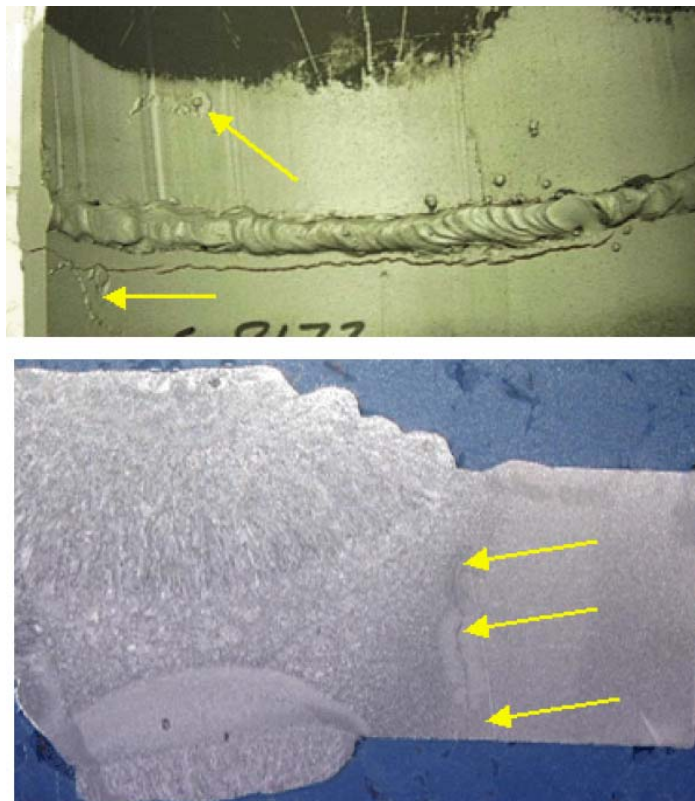
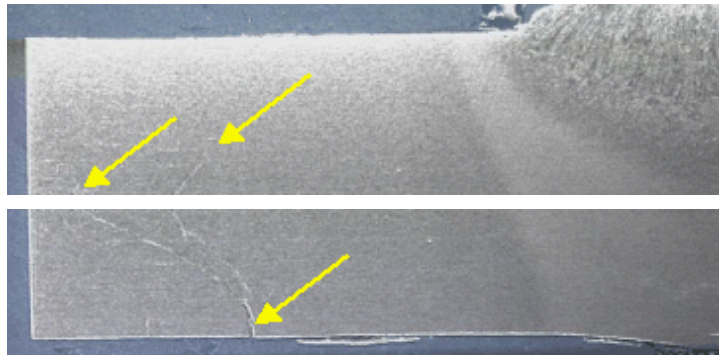


Figure 4-165 – SCC in steel pipe from a loading rack supply line. The top figure shows a 7-inch long crack parallel to the weld root on the pipe ID surface. The bottom picture is a cross-section of above crack showing initiation outside the weld heat affected zone on the pipe's inside surface (Nital etch).



**Figure 4-166 – SCC of steel piping in a fuel ethanol system return line/tank transfer line. The top picture shows the crack parallels the pipe-to-tee circumferential weld. The bottom picture shows the inside and outside of the pipe after splitting and cleaning the weld area. Parallel SCC cracks are clearly visible adjacent to the weld.**

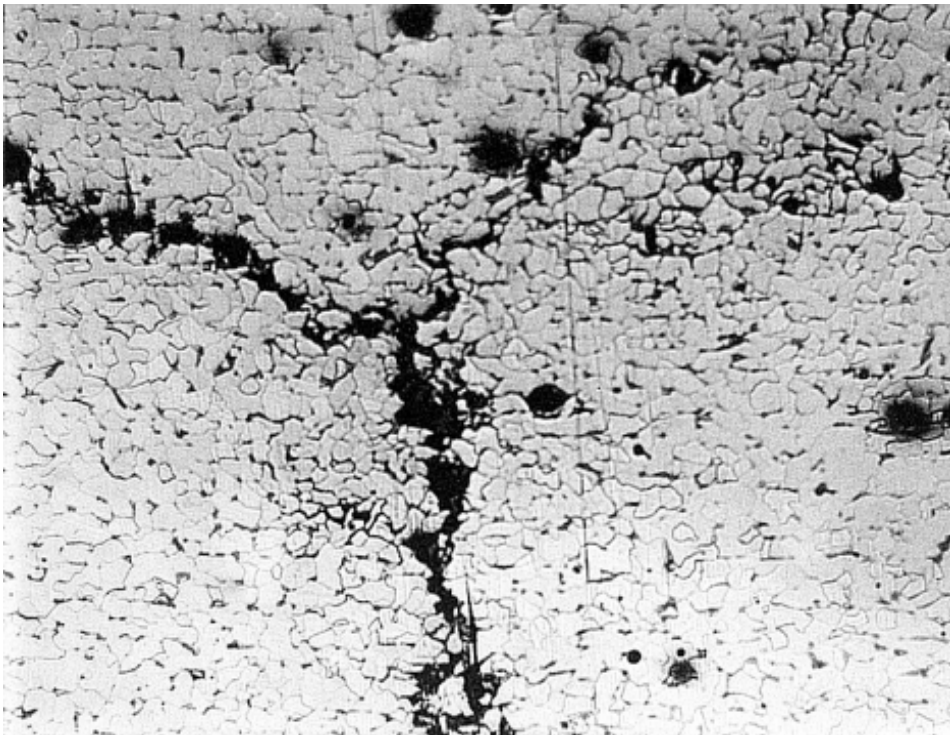




**Figure 4-167 – The top picture shows cracking initiating in the base metal on the ID of a section of piping adjacent to the weld. The bottom picture is a high magnification photomicrograph of the crack above illustrating the predominately intergranular nature of the cracking. (380X – Nital etch)**



**Figure 4-168 – Transverse cross-section of a piping section exposed to fuel ethanol showing multiple crack initiation sites characteristics of SCC.**



**Figure 4-169 – Photomicrograph of SCC in a steel tank bottom showing highly branched, intergranular cracks at 100 X.**

## **4.5.8 Sulfate Stress Corrosion Cracking**

### **4.5.8.1 Description of Damage**

Surface initiated cracks caused by environmental cracking of copper alloys in sulfate solutions over many years. Most commonly found in heat exchanger tubes, primarily in cooling water services.

### **4.5.8.2 Affected Materials**

- a) Some copper alloys are highly susceptible, especially admiralty brass.
- b) The 90/10 and 70/30 copper nickel alloys are more resistant.

### **4.5.8.3 Critical Factors**

- a) Susceptible alloys may suffer cracking under the combination of stress and the presence of sulfate chemical compounds. Residual stresses are sufficient to promote cracking.
- b) The process environment must contain sulfates as part of the process or where sulfates can form due to reactions with other chemical species.
- c) Ammonia is usually present, often at very low concentrations.
- d) Cracking usually occurs over a period of many years, sometimes taking as long as 10 to 15 years to cause tube leaks.

### **4.5.8.4 Affected Units or Equipment**

Sulfate SCC is most often associated with tubes in heat exchanger bundles in overhead distillation systems where sulfates can form or are present in low concentrations. Crude tower overhead exchangers are one example where this form of damage has been observed.

### **4.5.8.5 Appearance or Morphology of Damage**

- a) Exchanger tubes show single or highly branched cracks on the surface.
- b) Upon metallurgical examination, the cracks will have a branched, transgranular appearance which may be visually difficult to differentiate from ammonia stress corrosion cracking.
- c) Tube failures usually result in slow leaks as opposed to tube rupture.

### **4.5.8.6 Prevention / Mitigation**

- a) It has been suggested that the life of susceptible copper alloy exchanger tubes may be lengthened by periodic cleaning once every five years but limited published information is available to support this claim.
- b) Alloys that are highly resistant to ammonia stress corrosion cracking such as the 90-10CuNi and 70-30CuNi alloys are also highly resistant to sulfate SCC.
- c) Non-copper based alloys are immune from this form of damage.

### **4.5.8.7 Inspection and Monitoring**

- a) Inspect heat exchanger tubes for cracking using EC or visual inspection.
- b) Physical bending of sample tubes can also be performed to detect shallow cracks indicative of sulfate SCC in the beginning stages.

#### **4.5.8.7.1 Related Mechanisms**

Not applicable.

**4.5.8.8 References**

1. H.W. Pickering and P. J. Byne, "Stress-Corrosion of X-Brass in an Acid Sulfate Solution", *Corrosion*, Vol. 29, 1973, p 325..
2. H.H. Uhlig, *The Corrosion Handbook*, The Electrochemical Society – John Wiley and Sons, 1958.
3. *ASM Metals Handbook*, Ninth Edition, Volume 13, ASM International, Metals Park, OH, pages 635-636.
4. J.B. Cotton, in *Second International Congress on Metallic Corrosion* (New York, NY), National Association of Corrosion Engineers, 1963, p 590.

## SECTION 5

### REFINING INDUSTRY DAMAGE MECHANISMS

5.1	General.....	5-3
5.1.1	Uniform or Localized Loss in Thickness Phenomena.....	5-3
5.1.1.1	Amine Corrosion.....	5-3
5.1.1.2	Ammonium Bisulfide Corrosion (Alkaline Sour Water).....	5-9
5.1.1.3	Ammonium Chloride Corrosion.....	5-13
5.1.1.4	Hydrochloric Acid (HCl) Corrosion.....	5-16
5.1.1.5	High Temp H <sub>2</sub> /H <sub>2</sub> S Corrosion.....	5-19
5.1.1.6	Hydrofluoric (HF) Acid Corrosion.....	5-23
5.1.1.7	Naphthenic Acid Corrosion (NAC).....	5-31
5.1.1.8	Phenol (Carbolic Acid) Corrosion.....	5-35
5.1.1.9	Phosphoric Acid Corrosion.....	5-37
5.1.1.10	Sour Water Corrosion (Acidic).....	5-39
5.1.1.11	Sulfuric Acid Corrosion.....	5-41
5.1.1.12	Aqueous Organic Acid Corrosion.....	5-45
5.1.2	Environment-Assisted Cracking.....	5-49
5.1.2.1	Polythionic Acid Stress Corrosion Cracking (PASCC).....	5-49
5.1.2.2	Amine Stress Corrosion Cracking.....	5-55
5.1.2.3	Wet H <sub>2</sub> S Damage (Blistering/HIC/SOHIC/SSC).....	5-60
5.1.2.4	Hydrogen Stress Cracking - HF.....	5-70
5.1.2.5	Carbonate Stress Corrosion Cracking (ACSCC).....	5-72
5.1.3	Other Mechanisms.....	5-83
5.1.3.1	High Temperature Hydrogen Attack (HTHA).....	5-83
5.1.3.2	Titanium Hydriding.....	5-90
5.2	Process Unit PFD's.....	5-94

*This page intentionally left blank.*

## 5.1 General

Damage mechanisms found in the refining environment are discussed in the following sections. Section 5.2 includes process unit PFD's. These PFD's show the location in the unit where particular damage mechanisms are most likely to be found.

### 5.1.1 Uniform or Localized Loss in Thickness Phenomena

#### 5.1.1.1 Amine Corrosion

##### 5.1.1.1.1 *Description of Damage*

- a) Amine corrosion refers to the general and/or localized corrosion that occurs principally on carbon steel in amine treating processes. Corrosion is not caused by the amine itself, but results from dissolved acid gases (CO<sub>2</sub> and H<sub>2</sub>S), amine degradation products, Heat Stable Amine Salts (HSAS) and other contaminants.
- b) Stress corrosion cracking of carbon steel in amine services is discussed in [5.1.2.2](#).

##### 5.1.1.1.2 *Affected Materials*

Primarily carbon steel. 300 Series SS are highly resistant.

##### 5.1.1.1.3 *Critical Factors*

- a) Corrosion depends on design and operating practices, the type of amine, amine concentration, contaminants, temperature and velocity.
- b) Amine corrosion is very closely tied to the operation of the unit. With a few exceptions, carbon steel is suitable for most components in a properly designed and operated unit. Most problems can be traced to faulty design, poor operating practices or solution contamination.
- c) Corrosion is also dependent on the type of amine used. In general, alkanolamine systems can be rated in order of aggressiveness from most to least as follows: monoethanolamine (MEA), diglycolamine (DGA), diisopropylamine (DIPA), diethanolamine (DEA), and methyldiamine (MDEA).
- d) Lean amine solutions are generally not corrosive because they have either low conductivity and or high pH. However, an excessive accumulation of heat stable amine salts (HSAS) above about 2%, depending on the amine, can significantly increase corrosion rates.
- e) Lean amine solutions contain a small amount of H<sub>2</sub>S which helps to maintain a stable iron sulfide film. Overstripped lean solutions can be corrosive if there is inadequate H<sub>2</sub>S present to maintain the protective iron sulfide film.
- f) Ammonia, H<sub>2</sub>S and HCN accelerate corrosion in the regenerator overhead condenser and outlet piping as well as reflux piping, valves and pumps.
- g) Corrosion rates increase with increasing temperature, particularly in rich amine service. Temperatures above about 220°F (104°C) can result in acid gas flashing and severe localized corrosion due to 2-phase flow, if the pressure drop is high enough.
- h) Process stream velocity will influence the amine corrosion rate and nature of attack. Corrosion is generally uniform however high velocities and turbulence will cause localized thickness losses. For carbon steel, common velocity limits are generally limited to 3 to 6 fps for rich amine and about 20 fps for lean amine.

##### 5.1.1.1.4 *Affected Units or Equipment*

- a) Amine units are used in refineries to remove H<sub>2</sub>S, CO<sub>2</sub> and mercaptans from process streams originating in many units including the crude, coker, FCC, hydrogen reforming, hydroprocessing, and tail gas units.

- b) The regenerator reboiler and the regenerator are areas where the temperature and turbulence of the amine stream are the highest and can cause significant corrosion problems.
- c) The rich amine side of the lean/rich exchangers, hot lean amine piping, hot rich amine piping, the amine solution pumps, and the reclaimers are also areas where corrosion problems occur.

#### **5.1.1.1.5 Appearance or Morphology of Damage**

- a) Carbon steel and low alloy steels suffer general uniform thinning, localized corrosion or localized underdeposit attack (Figure 5-1 to 5-6).
- b) Thinning will be uniform in nature when the process stream velocity is low while it will be localized for high velocities associated with turbulence.

#### **5.1.1.1.6 Prevention / Mitigation**

- a) Proper operation of the amine system is the most effective way to control corrosion, with particular attention to acid gas loading levels. In addition, to avoid corrosive amine degradation products, the process temperature should not exceed recommended limits. Proper control of the reboiler rate and temperature is necessary in order to maintain a regenerator top temperature.
- b) Proper attention should be given to avoid the buildup of HSAS to unacceptable levels.
- c) The system design should incorporate measures to control local pressure drop to minimize flashing. In areas where it is unavoidable, upgrading to 300 Series SS or other corrosion resistant alloys may be required. SS410 trays and internals are also used in absorber and stripping towers.
- d) Oxygen inleakage causes high corrosion rates and contributes to heat stable salt formation. Storage tanks and surge vessels should be blanketed with inert gas.
- e) Solids and hydrocarbons should be removed from the amine solution by filtration and through process control. Filtration of rich amine solutions has the potential to be more effective than lean amine filtration for solids removal.
- f) Corrosion inhibitors may be required to control amine corrosion within acceptable levels.

#### **5.1.1.1.7 Inspection and Monitoring**

- a) Visual examination and UT thickness measurement are the methods used for internal equipment inspection. UT scans or profile radiography are used for external inspection.
- b) Corrosion monitoring can also be achieved with corrosion coupons and/or corrosion probes.
- c) Monitoring should target the hot areas of the unit such as the reboiler feed and return line, the hot lean/rich amine piping, and the stripper overhead condenser piping.
- d) Fouling of exchangers and filters can be a sign of corrosion problems on the unit.

#### **5.1.1.1.8 Related Mechanisms**

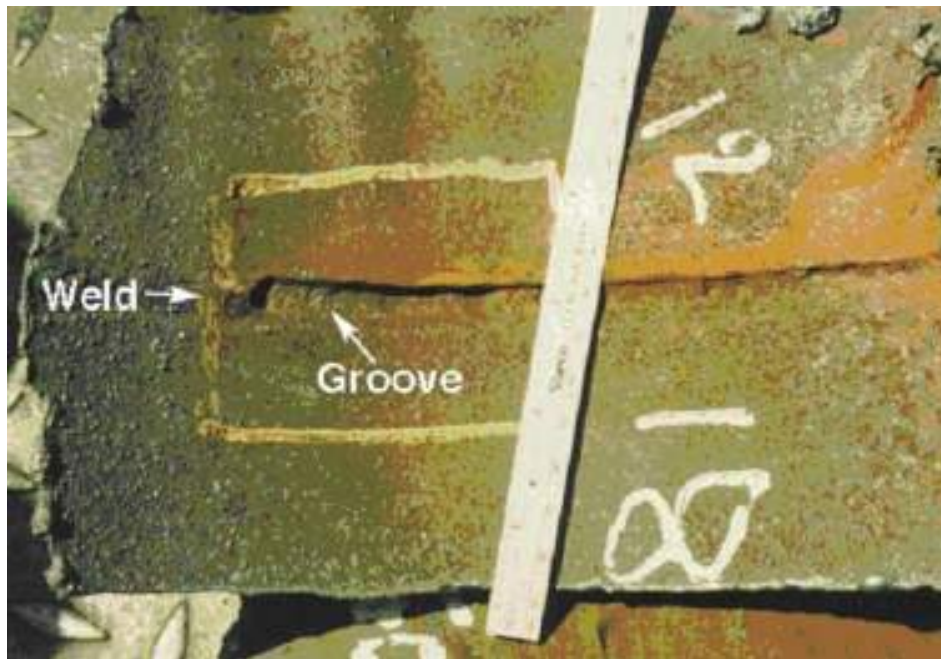
Amine stress corrosion cracking may also be found in 5.1.2.2.

#### **5.1.1.1.9 References**

1. J. Gutzeit "Refinery Corrosion Overview," Process Industries Corrosion - The Theory and Practice, NACE International, Houston, TX, 1986, pp. 171-189.
2. L.R. White and D.E. Street, "Corrosion Control in Amine Treating Units," Proceedings of the Special Symposium on Corrosion in the Oil Refining Industry, NACE International, Houston, TX, 1996.
3. R.B. Nielsen et al, "Corrosion in Refinery Amine Systems,"CORROSION/95, Paper No. 571, NACE International, Houston, TX, 1995.
4. API Recommended Practice 945, Avoiding Environmental Cracking in Amine Units, American Petroleum Institute, Washington, D.C.
5. M. A. Saleem and A.A. Hulaibi, , "Corrosion Challenges in Gas Treating Units", Paper # 08416, NACE International, Houston, TX, 2008.



6. P. Quiroga et al., "Improving Amine Unit Reliability with On-line Corrosion Monitoring & Modeling", Paper # 08421, NACE International, Houston, TX, 2008.
7. D. Fan et al., "Role of Impurities and H<sub>2</sub>S in Refinery Lean DEA System Corrosion", Paper #00495, NACE International, Houston, TX, 2004.



**Figure 5-1 – Localized amine corrosion at the weld found in piping from reboiler to regenerator tower in an MEA unit. Many other similar cases found, some going as deep as half thickness. They were originally found and mistaken as cracks with shear wave UT inspection.**



**Figure 5-2 – Hot Lean Amine Corrosion of Carbon Steel:**



Figure 5-3 – Preferential weld corrosion in lean amine (Reference 5)



Figure 5-4 – Preferential corrosion in amine regenerator reboiler return elbow (Reference 6).

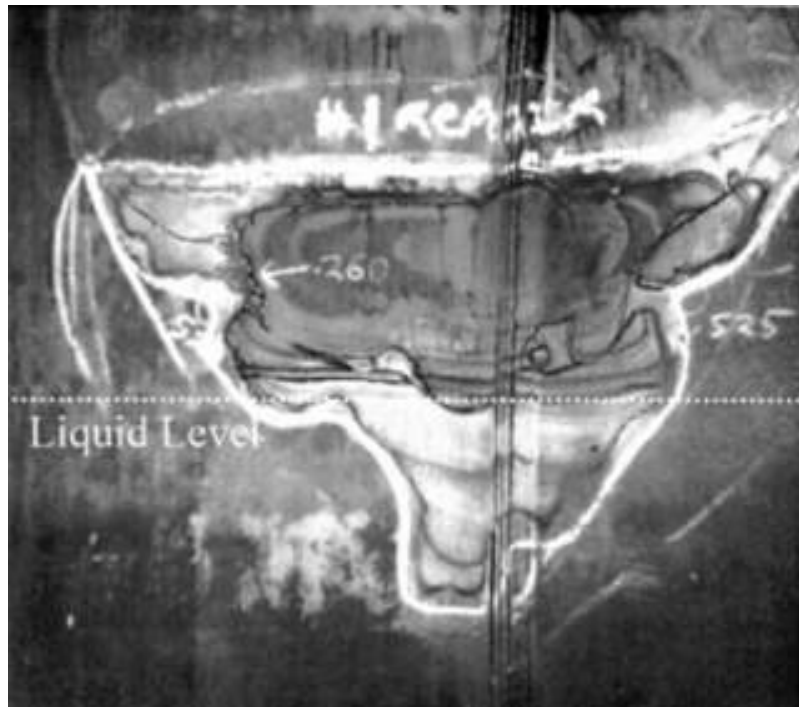


Figure 5-5 – Corroded reboiler exchanger shell near liquid level from an amine regeneration unit, (Numbers drawn on figure are UT thicknesses in inches. Nominal wall 0.550 inch (Reference 7)).

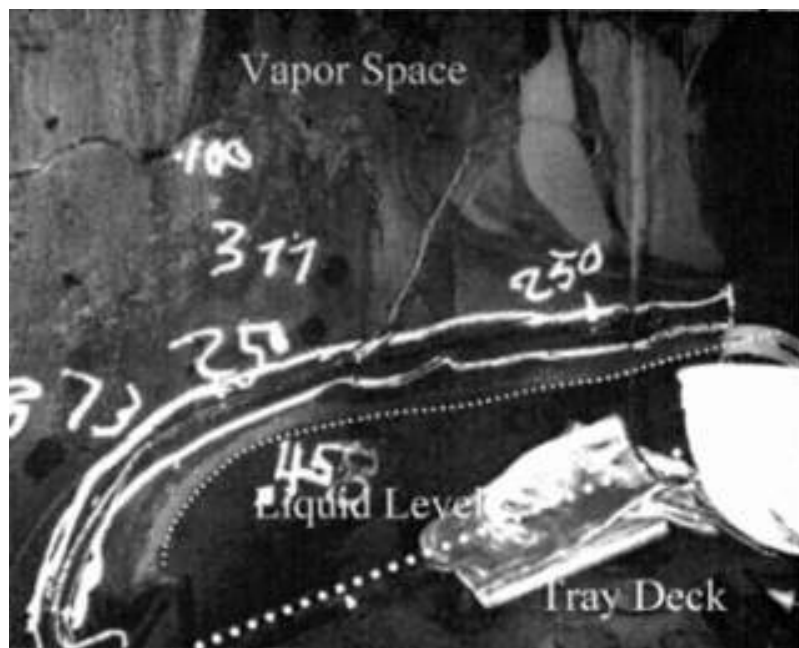


Figure 5-6 – Corroded amine regenerator column shell near a downcomer (Numbers drawn on figure are UT thicknesses in inches). Nominal Wall 0.500 inch (Reference 7).

### 5.1.1.2 Ammonium Bisulfide Corrosion (Alkaline Sour Water)

#### 5.1.1.2.1 Description of Damage

- a) Aggressive corrosion occurring in hydroprocessing reactor effluent streams and in units handling alkaline sour water.
- b) Several major failures have occurred in hydroprocessing reactor effluent systems due to localized corrosion.

#### 5.1.1.2.2 Affected Materials

- a) Carbon steel is less resistant.
- b) 300 Series SS, duplex SS, aluminum alloys and nickel base alloys are more resistant, depending on ammonium bisulfide ( $\text{NH}_4\text{HS}$ ) concentration and velocity.

#### 5.1.1.2.3 Critical Factors

- a)  $\text{NH}_4\text{HS}$  concentration,  $\text{H}_2\text{S}$  partial pressure, velocity and/or localized turbulence, pH, temperature, alloy composition and flow distribution are all critical factors to consider.
- b) Corrosion increases with increasing  $\text{NH}_4\text{HS}$  concentration and increasing velocity. Below 2 wt %, solutions are not generally corrosive. Above 2 wt %  $\text{NH}_4\text{HS}$ , solutions are increasingly corrosive.
- c) In hydroprocessing reactors, FCC reactors and coker furnaces, nitrogen in the feed is converted to ammonia and reacts with  $\text{H}_2\text{S}$  to form  $\text{NH}_4\text{HS}$ .  $\text{NH}_4\text{HS}$  precipitates out of the gas phase in the reactor effluent stream at temperatures below about 150°F (66°C), depending on the concentration of  $\text{NH}_3$  and  $\text{H}_2\text{S}$ , and may cause fouling and plugging unless flushed away with wash water.
- d)  $\text{NH}_4\text{HS}$  salt deposits lead to underdeposit corrosion and fouling. The salts are not corrosive unless they become hydrated at which point they are very corrosive.
- e) Oxygen and iron in the wash water injected into hydroprocessing reactor effluent can lead to increased corrosion and fouling.
- f) Presence of cyanides increases severity of corrosion in FCC gas plants, coker gas plants and sour water stripper overheads by destroying the normally protective sulfide film.

#### 5.1.1.2.4 Affected Units or Equipment

- a) Hydroprocessing Units
  - 1)  $\text{NH}_4\text{HS}$  salts precipitate in the reactor effluent streams when temperatures drop to within the range of 120°F to 150°F (49°C to 66°C).
  - 2) Fouling and/or velocity accelerated corrosion may be found at:
    - Air cooler header boxes.
    - Inlet and outlet piping of air coolers, as well as exchanger tubes.
    - Effluent separators, and piping into and out of the reactor effluent separators.
    - Sour water draw piping from reactor effluent separators; flashing may cause severe erosion-corrosion downstream of control valves (Figure 5-7).
    - Vapor line from the high pressure separators.
    - Hydrocarbon lines from reactor effluent separators due to entrained sour water.
    - Stripper Column overhead sour water.
- b) FCC Units

$\text{NH}_4\text{HS}$  concentrations are usually less than 2 wt % but high velocities and/or the presence of cyanides can remove protective iron sulfide scales.

## c) Sour Water Strippers (SWS)

High concentrations of  $\text{NH}_4\text{HS}$  in stripper overhead piping, condensers, accumulator and reflux piping, and possible presence of cyanides.

## d) Amine Units

High concentrations of  $\text{NH}_4\text{HS}$  may be found in regenerator overheads and reflux piping depending on unit operation.

## e) Delayed Coker

High concentrations of  $\text{NH}_4\text{HS}$  may be found in the gas concentration plant downstream of the fractionator tower.

**5.1.1.2.5      *Appearance or Morphology of Damage***

- a) General loss in thickness of carbon steel, with the potential for extremely high localized rates of wall loss can occur at changes in direction or turbulent flow areas above 2 wt % concentration.
- b) Low velocities may result in extremely localized under-deposit corrosion if insufficient water is available to dissolve the  $\text{NH}_4\text{HS}$  salts that precipitated.
- c) Heat exchangers may show plugging and loss of duty due to fouling.
- d)  $\text{NH}_4\text{HS}$  rapidly corrodes admiralty brass tubes and other copper alloys.

**5.1.1.2.6      *Prevention / Mitigation***

- a) Good design practice should consist of symmetrical and hydraulically balanced flow in and out of air cooled exchangers.
- b) Carefully review design and localized velocities as process conditions change, particularly as  $\text{NH}_4\text{HS}$  concentrations exceed 2 wt % and begin to approach 8 wt % or higher.
- c) Maintain velocities within industry guidelines of 10 to 20 fps for carbon steel. Carbon steel may be susceptible to high corrosion rates above about 8 wt %  $\text{NH}_4\text{HS}$  concentration
- d) Use resistant materials of construction (e.g. Alloy 825, duplex SS) at velocities above 20 fps, depending on  $\text{NH}_4\text{HS}$  concentration.
- e) Properly design and maintain water wash injection with low oxygen content; provide sufficient excess water to ensure that an adequate amount of water remains as liquid to dilute the  $\text{NH}_4\text{HS}$  salts. Use proper injection spray nozzles and metallurgy.
- f) Titanium and Alloy C276 have been used in overhead condensers in SWS units.
- g) Aluminum exchanger tubes are extremely susceptible to erosion-corrosion damage.

**5.1.1.2.7      *Inspection and Monitoring***

- a) A carefully designed plan should include input from process engineers and materials/corrosion engineers to determine specific areas of vulnerability. Determine ammonium bisulfide content through sampling and calculation.
- b) Frequent UT scanning and/or RT profile thickness of high and low velocity areas.
- c) UT downstream of control valves at high  $\text{NH}_4\text{HS}$  concentrations.
- d) IRIS, RFEC and flux leakage inspection of steel air cooler tubes.
- e) EC inspect non-magnetic air cooler tubes.
- f) Monitor water injection facilities and flow meters to ensure proper operation.

**5.1.1.2.8      *Related Mechanisms***

Erosion/erosion corrosion (see [4.2.14](#)).

**5.1.1.2.9 References**

1. R. L. Piehl, "Survey of Corrosion in Hydrocracker Effluent Air Coolers," Materials Protection, NACE International, Houston, TX, 1976.
2. E. F. Ehmke, "Corrosion Correlation with Ammonia and Hydrogen Sulfide in Air Coolers," Materials Protection, NACE International, Houston, TX, 1975.
3. J. Turner, "Control Corrosion in Washwater Systems," Hydrocarbon Processing, June 1997, pp. 87-95.
4. C. Harvey and A. Singh, "Mitigate Failures for Reactor Effluent Air Coolers," Hydrocarbon Processing, October 1999, pp. 59-72.
5. C. A. Shargay and G. E. Jacobs "Ammonium Salt Corrosion in Hydrotreating Unit Stripper Column Overhead Systems," Paper #392,CORROSION/99, April 1999, NACE International, Houston,TX, 1999.
6. NACE International Publication 34101, "Refinery Injection and Process Mixing Points," NACE International, Houston,TX, 2001.
7. API RP 932-B, "Design, Materials, Fabrication, Operation and Inspection Guidelines for Corrosion Control in Hydroprocessing Reactor Effluent Air Cooler (REAC) Systems", American Petroleum Institute, Washington, D.C.
8. Cathleen Shargay and Stephen Marciniec, "Analyzing water washing requirements for low severity hydroprocessing units", paper # 04646, NACE International, Houston,TX.
9. Richard J. Horvath, Michael S. Cayard, Russell D. Kane, "Prediction and assessment of ammonium bisulfide corrosion under refinery sour water service conditions", paper # 06576, NACE International, Houston, TX.
10. Hirohito Iwawaki and Kazuhiro Toba , "Corrosion Behavior of Steels in Concentrated NH<sub>4</sub>HS Environments", paper # 07576, NACE International, Houston,TX.
11. Richard J. Horvath et al., "PREDICTION AND Assessment of Ammonium Bisulfide Corrosion Under Refinery Sour Water Service Conditions - Part 2", CORROSION 2010, paper # 10349, NACE International, Houston,TX.

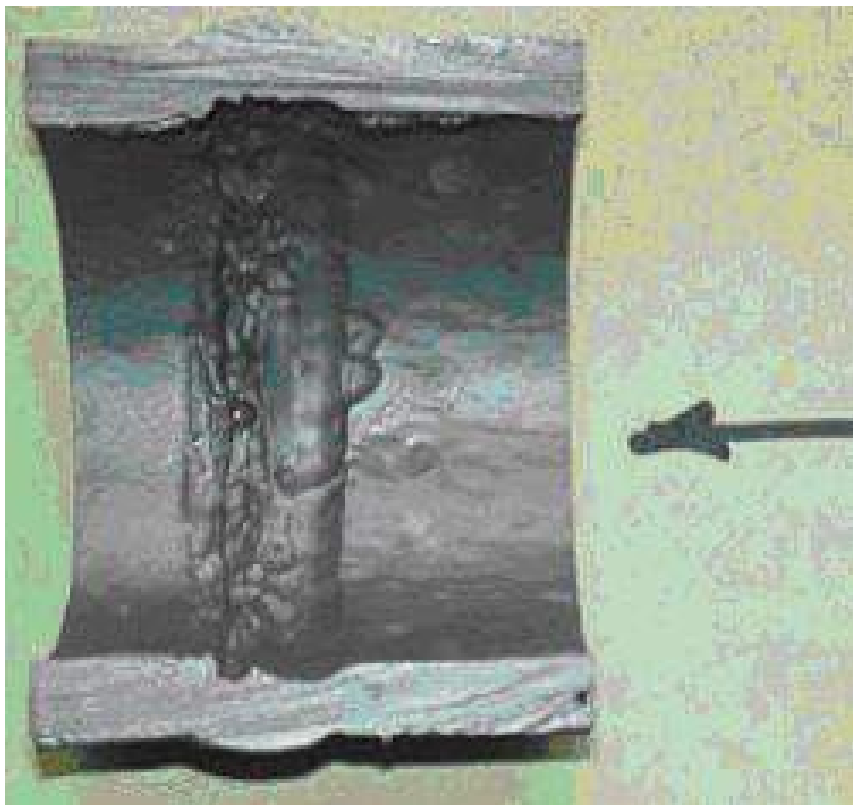


Figure 5-7 – 2-inch CS elbow and straight section in a sour water line off the cold HPS on an HDT unit.



### 5.1.1.3 Ammonium Chloride Corrosion

#### 5.1.1.3.1 Description of Damage

General or localized corrosion, often pitting, normally occurring under ammonium chloride or amine salt deposits, often in the absence of a free water phase.

#### 5.1.1.3.2 Affected Materials

All commonly used materials are susceptible, in order of increasing resistance: carbon steel, low alloy steels, 300 Series SS, Alloys 400, duplex SS, 800, and 825, Alloys 625 and C276 and titanium.

#### 5.1.1.3.3 Critical Factors

- a) Concentration ( $\text{NH}_3$ , HCl,  $\text{H}_2\text{O}$  or amine salts), temperature and water availability are the critical factors.
- b) Ammonium chloride salts may precipitate from high temperature streams as they are cooled, depending upon the concentration of  $\text{NH}_3$  and HCl, and may corrode piping and equipment at temperatures well above the water dewpoint [ $> 300^\circ\text{F}$  ( $149^\circ\text{C}$ )]
- c) Ammonium chloride salts are hygroscopic, and readily absorb water. A small amount of water can lead to very aggressive corrosion [ $>100$  mpy ( $>2.5$  mm/y)].
- d) Ammonium chloride and amine hydrochloride salts are highly water soluble, highly corrosive and form an acidic solution when mixed with water. Some neutralizing amines react with chlorides to form amine hydrochlorides that can act in a similar fashion.
- e) Corrosion rates increase with increasing temperature.
- f) When they deposit above the water dewpoint, a water wash injection may be required to dissolve the salts.

#### 5.1.1.3.4 Affected Units or Equipment

- a) Crude Tower Overheads
  - 1) Tower top, top trays, overhead piping and exchangers may be subject to fouling and corrosion. Deposits may occur in low flow zones due to ammonia and/or amine chloride salts condensing from the vapor phase.
  - 2) Top pumparound streams may be affected if ammonia or amine chloride salts are present.
- b) Hydroprocessing

Reactor effluent streams are subject to ammonium chloride salt fouling and corrosion. Water washing may be required if exchanger fouling or loss in duty occurs.
- c) Catalytic Reforming

Reactor effluent streams and the  $\text{H}_2$  recycle system are subject to ammonium chloride salting and corrosion.
- d) FCCU and coker fractionator overheads and top pumparounds are subject to ammonium chloride corrosion and salting.

#### 5.1.1.3.5 Appearance or Morphology of Damage

- a) The salts have a whitish, greenish or brownish appearance. Water washing and/or steamout will remove deposits so that evidence of fouling may not be evident during an internal visual inspection.
- b) Corrosion underneath the salts is typically very localized and results in pitting.
- c) Corrosion rates can be extremely high.

**5.1.1.3.6 Prevention / Mitigation**

Alloys that are more pitting resistant will have improved resistance to ammonium chloride salts but even the most corrosion resistant nickel base alloys and titanium alloys may suffer pitting corrosion.

- a) Crude Unit
  - 1) Limit salts by limiting chlorides in the tower feed through desalting and/or the addition of caustic to the desalted crude.
  - 2) A water wash may be required in the crude tower overhead line to flush the salt deposits.
  - 3) Filming amine inhibitors are often added to control corrosion.
- b) Hydroprocessing
  - 1) Limit chlorides in the hydrocarbon feed to the reactor.
  - 2) Limit chlorides in the make-up hydrogen supply.
  - 3) A continuous or intermittent water wash may be required in the reactor effluent to flush out the salt deposits.
- c) Catalytic Reforming
  - 1) Reactor effluent can be treated to remove the chlorides.
  - 2) Water washing has been used in some cases but the system must be carefully designed.
  - 3) Some tower overheads may require neutralizing or filming amines.

**5.1.1.3.7 Inspection and Monitoring**

- a) Accumulation of ammonium chloride salts can be very localized and the resulting corrosion may be difficult to detect.
- b) RT or UT thickness monitoring can be used to determine remaining wall thickness.
- c) Monitoring of the feed streams and effluent waters will give an indication of the amount of ammonia and chlorides present, however process simulation may be required to determine the concentration and dewpoint temperatures. If the ammonium chloride salt deposition temperature has been calculated, temperature monitoring and control may be effective for maintaining metal temperatures above the salt deposition temperature.
- d) The presence of deposits is often detected when the pressure drop increases or the thermal performance of exchangers has deteriorated.
- e) Corrosion probes or coupons can be useful, but the salt must deposit on the corrosion probe element to detect the corrosion.

**5.1.1.3.8 Related Mechanisms**

HCl corrosion (see [5.1.1.4](#)), chloride SCC ([4.5.1](#)) and organic acid corrosion of distillation tower overhead systems ([5.1.1.12](#)).

**5.1.1.3.9      *References***

1. C. Shargay et al, "Design Considerations to Minimize Ammonium Chloride Corrosion in Hydrotreater REACs," CORROSION/2001, Paper No. 1543, NACE International, Houston, TX, 2001.
2. C. Shargay et al, "Ammonium Salt Corrosion in Hydrotreating Unit Stripper Column Overhead Systems," NACE Corrosion/99 Conference, Paper No. 392, NACE International, Houston, TX, 1999.
3. "Refinery Injection and Process Mixing Points," NACE International Publication 34101, NACE International, Houston, TX, March 2001.
4. J. Turner, "Control Corrosion in Washwater Systems," Hydrocarbon Processing, June 1997, pp. 87-95.
5. NACE International Publication 34105, "Effect of Nonextractable Chlorides on Refinery Corrosion and Fouling", NACE International, Houston, TX.
6. NACE Publication 34109, "Crude Distillation Unit - Distillation Tower Overhead System Corrosion", NACE International, Houston, TX, January 2009.

#### 5.1.1.4 Hydrochloric Acid (HCl) Corrosion

##### 5.1.1.4.1 *Description of Damage*

- a) Hydrochloric acid (aqueous HCl) causes both general and localized corrosion and is very aggressive to most common materials of construction across a wide range of concentrations.
- b) Damage in refineries is most often associated with dew point corrosion in which vapors containing water and hydrogen chloride condense from the overhead stream of a distillation, fractionation or stripping tower. The first water droplets that condense can be highly acidic (low pH) and promote high corrosion rates.

##### 5.1.1.4.2 *Affected Materials*

All common materials of construction used in refineries.

##### 5.1.1.4.3 *Critical Factors*

- a) HCl acid concentration, temperature and alloy composition.
- b) The severity of corrosion increases with increasing HCl concentration and increasing temperature.
- c) Aqueous HCl can form beneath deposits of ammonium chloride or amine hydrochloride salts in exchangers and piping. The deposits readily absorb water from the process stream or from injected wash water. Hydrogen chloride is normally not corrosive in dry process streams, but becomes very corrosive where water is available to form hydrochloric acid.
- d) Carbon steel and low alloy steels are subject to excessive corrosion when exposed to any concentration of HCl acid that produces at pH below about 4.5
- e) 300 series SS and 400 series SS are not usefully resistant to HCl at any concentration or temperature.
- f) Alloy 400, titanium and some other nickel base alloys have good resistance to dilute HCl acid in many refinery applications.
- g) The presence of oxidizing agents (oxygen, ferric and cupric ions) will increase the corrosion rate, particularly for alloy 400 and Alloy B-2. Titanium performs well in oxidizing conditions but fails rapidly in dry HCl service.

##### 5.1.1.4.4 *Affected Units or Equipment*

HCl corrosion is found in several units, especially crude and vacuum units, hydroprocessing units and catalytic reformer units.

- a) Crude Unit
  - 1) In the atmospheric tower overhead system, corrosion from HCl acid occurs as the first droplets of water condense from the vapor stream off the top of the tower. This water can have a very low pH and can result in high rates of corrosion in piping, as well as exchanger shells, tubes and header boxes, and cold dead legs.
  - 2) HCl corrosion can also be a problem in the vacuum ejector and condensing equipment off the top of the vacuum tower.
- b) Hydroprocessing Units
  - 1) Chlorides may enter the unit as organic chloride in the hydrocarbon feed or with the recycle hydrogen and react to form HCl.
  - 2) Ammonium chloride salts can form in various parts of the unit including the effluent side of the hot feed/effluent exchangers because both  $\text{NH}_3$  and HCl are present or they may condense with water in the effluent train.

- 3) HCl containing streams can migrate through the fractionation section resulting in severe acid dewpoint corrosion at the mixing point where it contacts water.
- c) Catalytic Reforming Units
- 1) Chlorides may be stripped from the catalyst and react to form HCl that carries through the effluent train, regeneration system, stabilizer tower, debutanizer tower and feed/preheat exchangers.
  - 2) HCl containing vapors can migrate through the gas plant fractionation section resulting in mix point or acid dew point corrosion.

#### **5.1.1.4.5      *Appearance or Morphology of Damage***

- a) Carbon steel and low alloy steels suffer general uniform thinning, localized corrosion or underdeposit attack.
- b) 300 Series SS and 400 Series SS will often suffer pitting attack and 300 Series SS may experience chloride stress corrosion cracking.

#### **5.1.1.4.6      *Prevention/Mitigation***

- a) Crude Units
- 1) Optimize the crude oil tank water separation and withdrawal and crude desalting operation to reduce chloride in the feed to the crude tower. A common target is 20 ppm or fewer chlorides in the overhead accumulator water.
  - 2) Upgrading carbon steel to nickel base alloys or titanium can reduce HCl acid corrosion problems. Titanium tubes will solve most overhead condenser tube corrosion problems.
  - 3) Water washing can be added to quench the overhead stream and to help dilute the condensing hydrochloric acid concentration.
  - 4) Caustic injection downstream of the desalter is another common method used to reduce the amount of HCl going overhead. Proper design and operating guidelines must be used to avoid caustic SCC and fouling in the feed preheat train.
  - 5) Various combinations of ammonia, neutralizing amines and filming amines can be injected in the atmospheric tower overhead line before the water dewpoint.
- b) Hydrodroprocessing
- 1) Minimize carryover of water and chloride salts from upstream units including neutralizing amine hydrochloride salts.
  - 2) Minimize HCl in H<sub>2</sub> streams (e.g., install scrubbers or guard beds to remove Cl<sup>-</sup> ions from hydrogen produced in catalytic reforming units).
  - 3) Selective use of corrosion resistant nickel base alloys.
- c) Catalytic Reforming
- 1) Same as hydroprocessing, but in addition, water washing the hydrocarbon stream has also been used to remove the highly water soluble chlorides. Special care in the design and operation of this equipment is recommended. Minimizing water and/or oxygenates in the feed will reduce stripping of chlorides from the catalyst.
  - 2) Special adsorbents in chloride beds and chloride treaters can be used to remove chlorides from the recycle hydrogen streams and from liquid hydrocarbon streams.

#### **5.1.1.4.7      *Inspection and Monitoring***

- a) For carbon steel, damage is usually in the form of general thinning but may be highly localized where a water phase is condensing.

- b) Serious corrosion can also be found at mix points where dry chloride containing streams mix with streams containing free water or where water saturated streams are cooled below the dewpoint.
- c) Evidence of locally thinned areas can be found using automatic ultrasonic scanning methods or profile radiography.
- d) Process and corrosion monitoring are important aspects of a well-developed program to minimize the effects of HCl corrosion.
- e) The pH of the water in the boot of the atmospheric tower overhead accumulator is normally checked every shift. Other variables including chloride and iron content are checked on a less frequent basis but do need to be monitored regularly.
- f) Water phases in other units are also monitored by periodic sampling of water draws from the overhead drums of fractionating or stripping towers.
- g) Strategically placed corrosion probes and/or corrosion coupons can provide additional information on the rate and extent of damage.

#### **5.1.1.4.8      *Related Mechanisms***

Ammonium chloride corrosion (see [5.1.1.3](#)), chloride SCC ([4.5.1](#)) and organic acid corrosion of distillation tower overhead systems ([5.1.1.12](#)).

#### **5.1.1.4.9      *References***

1. Metals Handbook, "Corrosion," Volume 13, ASM International, Materials Park, OH.
2. A. Bagdasarian et al, "Crude Unit Corrosion and Corrosion Control," CORROSION/96, Paper No.615, NACE International, Houston, TX, 1996.
3. NACE International Publication 34105, "Effect of Nonextractable Chlorides on Refinery Corrosion and Fouling", NACE International, Houston, TX.

### 5.1.1.5 High Temp H<sub>2</sub>/H<sub>2</sub>S Corrosion

#### 5.1.1.5.1 *Description of Damage*

The presence of hydrogen in H<sub>2</sub>S-containing hydrocarbon streams increases the severity of high temperature sulfide corrosion at temperatures above about 500°F (260°C). This form of sulfidation usually results in a uniform loss in thickness associated with hot circuits in hydroprocessing units.

#### 5.1.1.5.2 *Affected Materials*

In order of increasing resistance: carbon steel, low alloy steels, 400 Series SS, and 300 Series SS.

#### 5.1.1.5.3 *Critical Factors*

- a) The major factors affecting high temperature sulfidation are the temperature, the presence of hydrogen, the concentration of H<sub>2</sub>S and the alloy composition.
- b) Depending on the quantity of hydrogen that is present, corrosion rates may be significantly different than those associated with high temperature sulfidation in the absence of hydrogen (see 4.4.2).
- c) Sulfidation rates increase with increasing H<sub>2</sub>S content and especially increasing temperature as illustrated in Figure 5-8.
- d) Higher corrosion rates are found more in gas oil desulfurizers and hydrocrackers than naphtha desulfurizers by a factor of almost '2'.
- e) Susceptibility to sulfidation is determined by the chemical composition of the alloy.
- f) Increasing chromium content of the alloy improves resistance (Figure 5-9). However, there is little improvement with increasing chromium content until about 7-9Cr as shown by the relative rate reduction factors in Table 5-1.
- g) Chromium-containing nickel base alloys are similar to stainless steel. Similar levels of chromium provide similar corrosion resistance.

#### 5.1.1.5.4 *Affected Units or Equipment*

- a) This form of corrosion occurs in piping and equipment in units where high temperature H<sub>2</sub>/H<sub>2</sub>S streams are found including all hydroprocessing units such desulfurizers, hydrotreaters and hydrocracking units.
- b) Noticeable increases in corrosion may be found downstream of hydrogen injection points.

#### 5.1.1.5.5 *Appearance or Morphology of Damage*

- a) Corrosion will appear as a uniform loss in thickness from the process side and is accompanied by the formation of an iron sulfide scale.
- b) Scale is about 5 times the volume of lost metal and may be in multiple layers.
- c) The tightly adherent shiny gray scale attached to the surface may be mistaken for unaffected metal.

#### 5.1.1.5.6 *Prevention / Mitigation*

- a) The corrosion damage is minimized by using alloys with high chromium content.
- b) The 300 Series SS such as Types 304L, 316L, 321 and 347 are highly resistant at service temperatures.

#### 5.1.1.5.7 *Inspection and Monitoring*

- a) UT, VT and RT thickness readings are used to monitor loss in thickness.
- b) Actual operating temperatures should be verified in the field to compare against design.

- c) Process simulations should be checked periodically to confirm that H<sub>2</sub>S levels have not significantly increased.

**5.1.1.5.8      *Related Mechanisms***

High temperature sulfidation in the absence of hydrogen is discussed in [4.4.2](#)

**5.1.1.5.9      *References***

1. ASM Metals Handbook, "Corrosion in Petroleum Refining and Petrochemical Operations," Volume 13, ASM International, Materials Park, OH.
2. NACE Course Book, "Corrosion Control in the Refining Industry," NACE International, Houston, TX, 1999.



**Table 5-1 – Rate Factors vs. Chromium Content. (Reference 2)**

<b>Alloy</b>	<b>Rate Factor</b>
CS, C-0.5Mo	1
1 Cr-0.5Mo	0.96
2.25Cr-1Mo	0.91
5Cr-0.5Mo	0.80
7Cr-1Mo	0.74
9Cr-1Mo	0.68

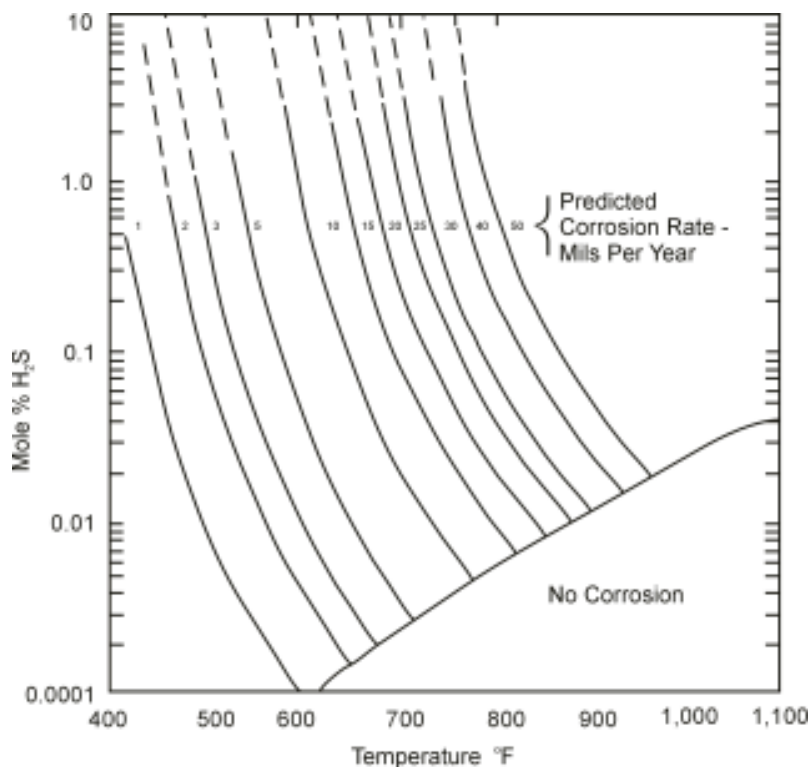


Figure 5-8 – Corrosion rate of carbon steel in H<sub>2</sub>/H<sub>2</sub>S service in a naphtha desulfurizer from the modified Couper-Gorman curves. (Reference 1)

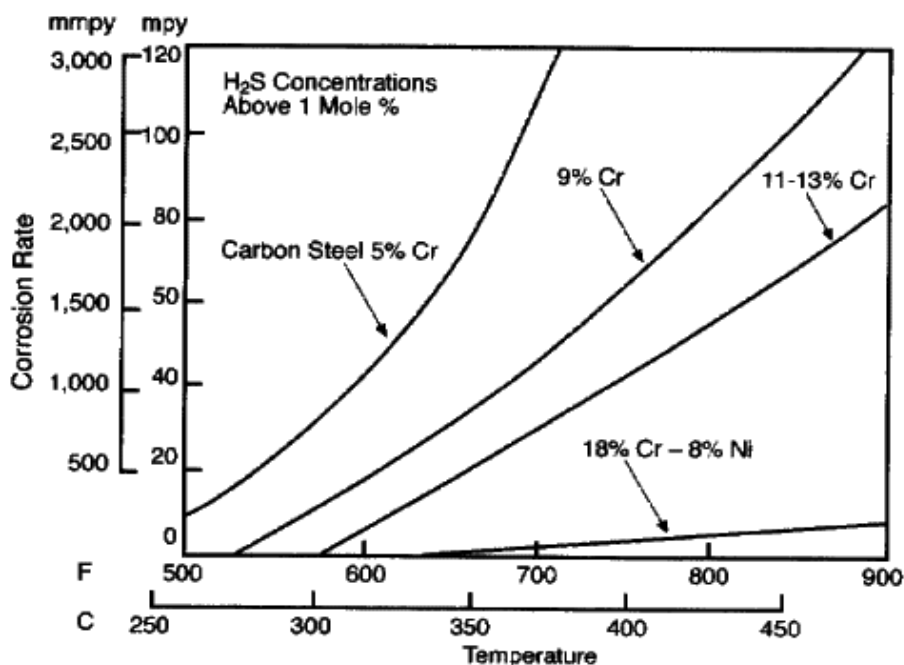


Figure 5-9 – Corrosion rate curves for various alloys in H<sub>2</sub>/H<sub>2</sub>S service. (Reference 1)

### 5.1.1.6 Hydrofluoric (HF) Acid Corrosion

#### 5.1.1.6.1 *Description of Damage*

Corrosion by HF acid can result in high rates of general or localized corrosion and may be accompanied by hydrogen cracking, blistering and/or HIC/SOHIC (see 5.1.2.3 and 5.1.2.4).

#### 5.1.1.6.2 *Affected Materials*

- a) Carbon steel, copper-nickel alloys, Alloy 400.
- b) Other nickel base alloys such as Alloy C276 have also been used in some applications.
- c) Low alloy steels, 300 Series SS and the 400 Series SS are susceptible to corrosion and/or cracking and are generally not suitable for HF service.

#### 5.1.1.6.3 *Critical Factors*

- a) HF acid concentration (water content), temperature, alloy composition and the presence of contaminants including oxygen and sulfur compounds are the controlling factors.
- b) Carbon steel forms a protective fluoride scale in dry concentrated acid. Loss of the protective scale through high velocities or turbulence, will result in greatly accelerated corrosion rates.
- c) The presence of water can destabilize the fluoride scale and convert it into a voluminous nonprotective scale.
- d) The primary concern is the "HF-in-water" concentration of the acid phase. Although the process stream may be comprised primarily of hydrocarbon, the acid is considered as a separate phase. Concentration is determined by the amount of water present in the acid phase.
- e) Typical HF alkylation units operate with 1% to 3% water in the acid, equivalent to an HF-in-water concentration of 97% to 99% and the temperatures are generally below 150°F (66°C). Under these conditions carbon steel is widely used for all equipment except where close tolerances are required for operation (i.e., pumps, valves, instruments).
- f) Corrosion rates increase with increasing temperature and decreasing HF concentration (increasing water content) as shown in Figures 5-10 to 5-11.
- g) In carbon steel, the "Residual Element" (RE) content of base metal and weld metal may have an affect on corrosion rates in certain parts of the unit. This RE content refers to the effect of trace elements, primarily %C, %Cu, %Ni, %Cr that are present in carbon steel during the steel manufacturing process (References 1- 4).
- h) Industry guidelines regarding RE content have been developed and implemented into some industry consensus standards as indicated below. A more detailed discussion of these guidelines is outlined in References 1 and 2.
  - 1) • For Base Metal:        %C > 0.18 wt.% and %Cu + %Ni < 0.15 wt.%
  - 2) • For Weld Metal:        %Cu + %Ni + %Cr < 0.15 wt.%
- i) Oxygen contamination increases the corrosion rate of carbon steel and promotes accelerated corrosion and SCC of Alloy 400.

#### 5.1.1.6.4 *Affected Units or Equipment*

- a) Piping and equipment in the HF alkylation unit, flare piping and downstream units exposed to acid carryover are also affected.
- b) Most equipment is made from carbon steel with the exception of the HF acid rerun/regenerator tower and the acid relief neutralizer vessel which are usually made partially or completely from Alloy 400.

- c) High corrosion rates have been observed:
  - 1) In piping and equipment operating above 150°F (66°C);
  - 2) In deadlegs including inlets to relief valves, as well as small bore vents and drains;
  - 3) Condensing overhead vapors in piping and exchangers off top of the Isostripper, Depropanizer and HF Stripper/Propane Stripper;
  - 4) On flange faces;
  - 5) Heat exchanger bundles that heat acid-containing streams such as the acid vaporizer.
- d) Severe fouling due to iron fluoride corrosion product has been observed in the piping, heat exchangers and in the tops of the Isostripper and Depropanizer towers.

#### **5.1.1.6.5      *Appearance or Morphology of Damage***

- a) Corrosion is in the form of localized general or severe thinning of carbon steel. Preferential corrosion may not always conform to behavior predicted by the RE guidelines in API RP 751 ([Figure 5-12 to 5-15](#)).
- b) Corrosion may be accompanied by cracking due to hydrogen stress cracking, blistering and/or HIC/SOHIC damage.
- c) Significant fouling due to iron fluoride scales may also accompany corrosion.
- d) Alloy 400 shows uniform loss in thickness but is not accompanied by significant scaling.
- e) Alloy 400 is susceptible to stress corrosion cracking when in contact with moist HF vapors in the presence of oxygen.

#### **5.1.1.6.6      *Prevention / Mitigation***

- a) Carbon steel operating above 150°F (66°C) should be closely monitored for loss in thickness and may need to be upgraded to Alloy 400.
- b) Corrosion can be prevented by careful operation of the unit to minimize water, oxygen, sulfur and other contaminants in the feed.
- c) Maintain strict controls on the water content of the circulating acid.
- d) Alloy 400 (solid or clad) can be used to eliminate the problems associated with blistering and HIC/SOHIC. A stress relieving heat treatment is required to help minimize, but not eliminate, the possibility of SCC ([Figure 5-16 to 5-18](#)).
- e) Alloy C276 has been used where there have been cracking problems with Alloy 400.

#### **5.1.1.6.7      *Inspection and Monitoring***

- a) UT and RT are used to monitor for loss in thickness.
- b) Special emphasis programs to monitor small bore piping, flange face corrosion, blistering and HIC/SOHIC are recommended as outlined in API RP 751.
- c) Track and monitor RE content of carbon steel components in accordance with API 751 guidelines. Inspect for the potential for localized corrosion of piping components and or welds in accordance with API 751 and industry best practices.

#### **5.1.1.6.8      *Related Mechanisms***

Environmental cracking of carbon steel and Alloy 400 can occur in HF. Refer to [5.1.2.4](#) hydrogen stress cracking in HF and to [5.1.2.3](#) for a discussion of blistering and HIC/SOHIC damage.

**5.1.1.6.9      References**

1. API Recommended Practice 751, Safe Operation of Hydrofluoric Acid Alkylation Units, American Petroleum Institute, Washington, D.C.
2. NACE Publication 5A171, Materials for Receiving, Handling, and Storing Hydrofluoric Acid, NACE International, Houston, TX.
3. H.H. Hashim and W.L. Valerioti, "Corrosion Resistance of Carbon Steel in HF Alkylation Service", *Materials Performance*, Nov 1993, p 50.
4. A. Gysbers et al., "Specification for Carbon Steel Materials for Hydrofluoric Acid Units," *CORROSION/2003*, Paper #. 03651 NACE International, Houston, TX, 2003.
5. J. D. Dobis, D. R. Clarida and J. P. Richert, "Survey Reveals Nature of Corrosion in HF Alkylation Units," *Oil and Gas Journal*, March 6, 1995, Vol. 93, No.10, pp. 63-68.
6. H.S. Jennings, "Materials for Hydrofluoric Acid Service in the New Millennium", *CORROSION/01*, Paper No.01345, NACE International, Houston, TX, 2001.
7. J. D. Dobis, D.G. Williams and D. L. Bryan Jr., "The Effect of Operating Conditions on Corrosion in HF Alkylation Units", *CORROSION/04*, Paper No.645, NACE International, Houston, TX, 2004.
8. J. D. Dobis, "The Top Ten Corrosion Issues Affecting HF Alkylation Units", *CORROSION/07*, NACE International paper #07570, Nashville, March 2007.
9. H.P.E. Helle, "Guidelines for Corrosion Control in HF-alkylation Units", 2nd Edition, New Plantation, Delft, Netherlands, April, 1993.
10. Clinton J. Schulz, "Corrosion Rates of Carbon Steel in HF Alkylation Service", Paper #06588, NACE International, Houston, TX, 2006.

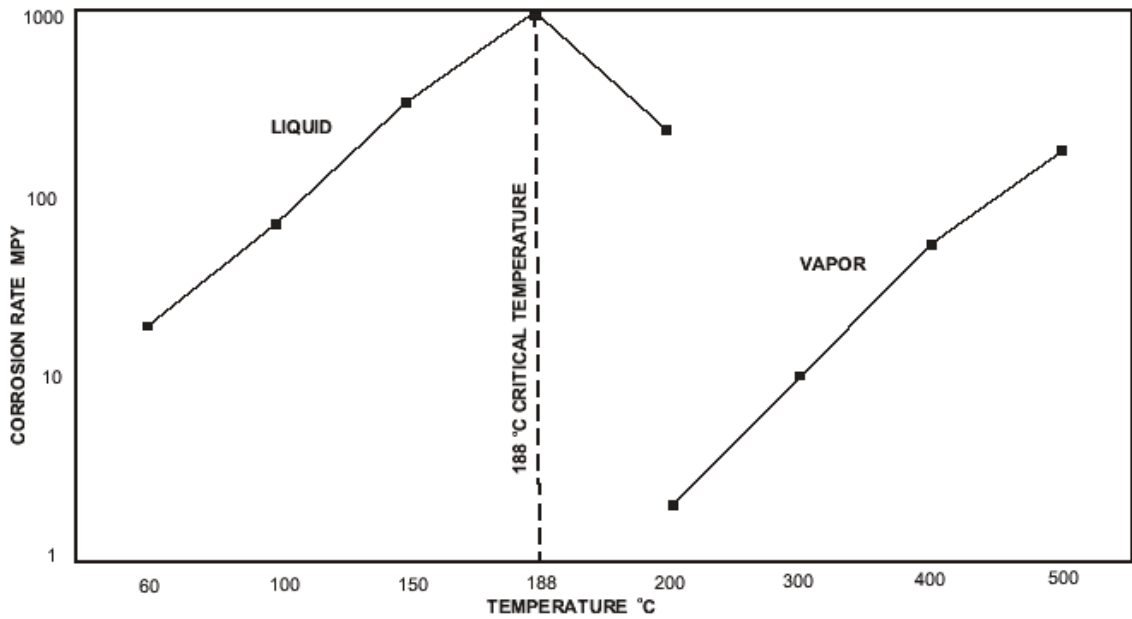


Figure 5-10 – Corrosion rate as a function of temperature for carbon steel in anhydrous HF acid under stagnant conditions in 100-hr laboratory test (Reference 2) .

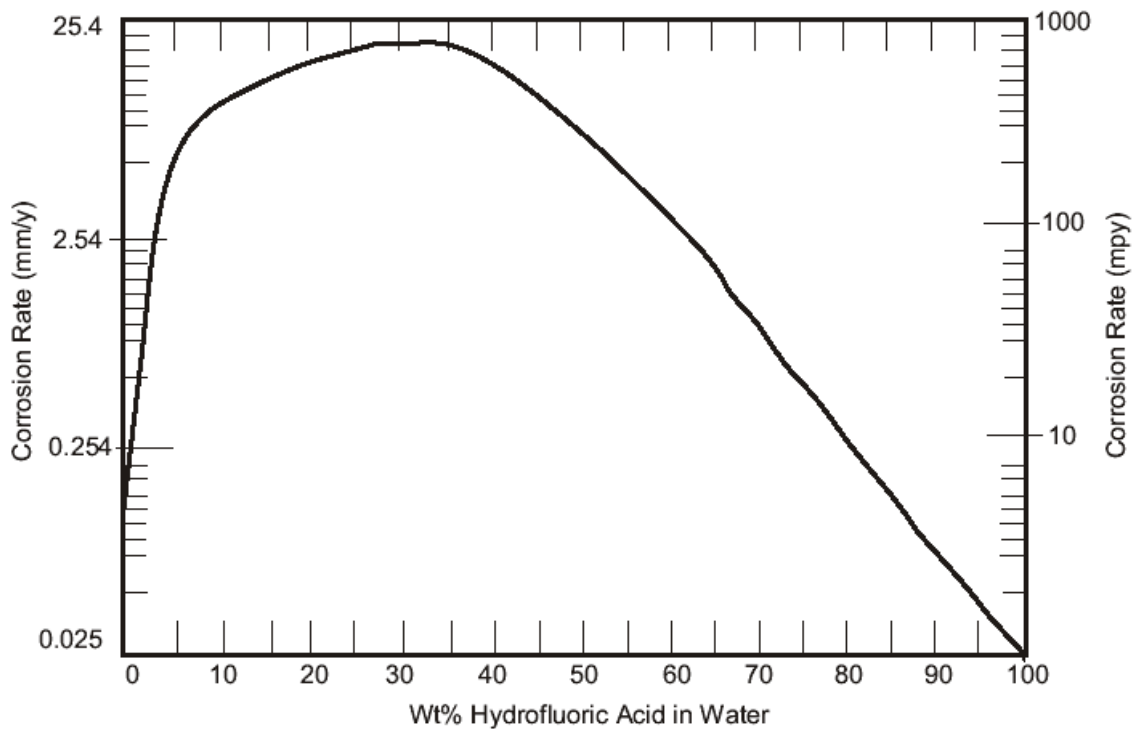


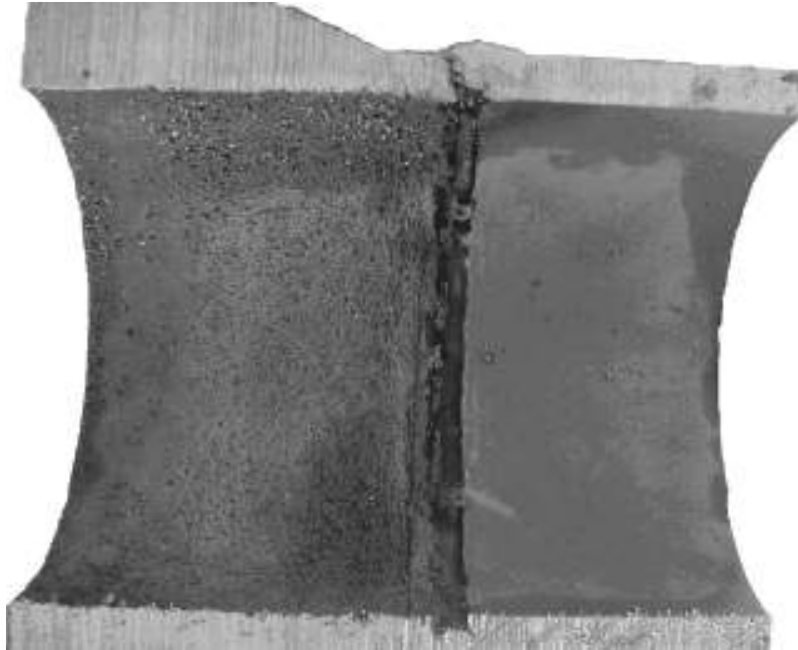
Figure 5-11 – The corrosion rate of carbon steel at 70°F to 100°F (21°C to 38°C) based on laboratory testing and field experience at low flow and no-flow conditions (Reference 2) .



Figure 5-12 – Cross-section of a carbon steel pipe showing preferential corrosion of the pipe with high residual element content on the right, as compared to the low residual pipe section to the left of the weld (Reference 3).



Figure 5-13 – Ruptured NPS 3 Sch. 80 0.216 in (5.49 mm) Depropanizer Feed Line operating <120°F  
Residual element content is as follows:  
Both Base metals: %C > 0.18 & %Cu + %Ni < 0.15  
Weld Metal: %Cu + %Ni + %Cr < 0.15



**Figure 5-14 – A cross-section of a line in fresh acid service showing accelerated corrosion of the weld and base metal of the component on the left (Reference 8).**



**Figure 5-15 – Accelerated corrosion in the heat affected zone of a carbon steel weldment.  
Residual element content is as follows (Reference 8):  
Both Base metals: %C > 0.18 wt. & %Cu + %Ni < 0.15  
Weld Metal: %Cu + %Ni + %Cr < 0.15**





Figure 5-16 – HF stress corrosion cracking of Alloy 400 vent line in an acid dump system (Reference 8).



Figure 5-17 – HF stress corrosion cracking of Alloy 400 instrument tubing (Reference 8).



**Figure 5-18 – HF Corrosion at manway in HF acid storage service.**

### 5.1.1.7 Naphthenic Acid Corrosion (NAC)

#### 5.1.1.7.1 *Description of Damage*

A form of high temperature corrosion that occurs primarily in crude and vacuum units, and downstream units that process certain fractions or cuts that contain naphthenic acids.

#### 5.1.1.7.2 *Affected Materials*

Carbon steel, low alloy steels, 300 Series SS, 400 Series SS and nickel base alloys.

#### 5.1.1.7.3 *Critical Factors*

- a) NAC is a function of the naphthenic acid content (neutralization number), temperature, sulfur content, velocity and alloy composition.
- b) Severity of corrosion increases with increasing acidity of the hydrocarbon phase.
- c) Neutralization number or Total Acid Number (TAN) is a measure of the acidity (organic acid content) as determined by various test methods such as ASTM D-664. However, NAC corrosion is associated with hot dry hydrocarbon streams that do not contain a free water phase.
- d) The Total Acid Number (TAN) of the crude may be misleading because this family of acids has a range of boiling points and tends to concentrate in various cuts. Therefore, NAC is determined by the acidity of the actual stream not the crude charge.
- e) The various acids which comprise the naphthenic acid family can have distinctly different corrosivity.
- f) No widely accepted prediction methods have been developed to correlate corrosion rate with the various factors influencing it.
- g) Sulfur promotes iron sulfide formation and has an inhibiting effect on NAC, up to a point.
- h) Naphthenic acids remove protective iron sulfide scales on the surface of metals.
- i) NAC can be a particular problem with very low sulfur crudes with TAN's as low as 0.10.
- j) NAC normally occurs in hot streams above 425°F (218°C) but has been reported as low as 350°F (177°C). Severity increases with temperature up to about 750°F (400°C), however, NAC has been observed in hot coker gas oil streams up to 800°F (427°C)
- k) Naphthenic acids are destroyed by catalytic reactions in downstream hydroprocessing and FCCU units.
- l) Alloys containing increasing amounts of molybdenum show improved resistance. A minimum of 2% to 2.5% is required depending on the TAN of the whole crude and its side cuts.
- m) Corrosion is most severe in two phase (liquid and vapor) flow, in areas of high velocity or turbulence, and in distillation towers where hot vapors condense to form liquid phase droplets.

#### 5.1.1.7.4 *Affected Units or Equipment*

- a) Crude and vacuum heater tubes; crude and vacuum transfer lines; vacuum bottoms piping, AGO circuits; HVGO and sometimes LVGO circuits. NAC has also been reported in the LCGO and HCGO streams on delayed coking units processing high TAN feed.
- b) Piping systems are particularly susceptible in areas of high velocity, turbulence or change of flow direction, such as pump internals, valves, elbows, tees and reducers as well as areas of flow disturbance such as weld beads and thermowells.
- c) Crude and vacuum tower internals may also be corroded in the flash zones, packing and internals where high acid streams condense or high velocity droplets impinge.

- d) NAC may be found in hot hydrocarbon streams downstream of the crude and vacuum units, upstream of any hydrogen mix points.

#### **5.1.1.7.5      *Appearance or Morphology of Damage***

- a) NAC is characterized by localized corrosion, pitting corrosion, or flow induced grooving in high velocity areas (Figure 5-19 and Figure 5-20).
- b) In low velocity condensing conditions, many alloys including carbon steel, low alloy steels and 400 Series SS may show uniform loss in thickness and/or pitting.

#### **5.1.1.7.6      *Prevention / Mitigation***

- a) For units and/or components of systems which have not been designed for resistance to NAC, the options are to change or blend crudes, upgrade metallurgy, utilize chemical inhibitors or some combination thereof.
- b) NAC can be reduced by blending crude to reduce the TAN and/or increase the sulfur content.
- c) Use alloys with higher molybdenum content for improved resistance (Table 5-2).
- d) High temperature NAC inhibitors have been used with moderate success, however potential detrimental effects on downstream catalyst activity must be considered. Inhibitors effectiveness needs to be monitored carefully.
- e) For severe conditions, Type 317L stainless steel or other alloys with higher molybdenum content may be required.

#### **5.1.1.7.7      *Inspection and Monitoring***

- a) UT and RT are used for thickness monitoring but localized erosion may be difficult to locate so RT should be the primary detection method followed by UT thickness measurement.
- b) Monitor TAN and sulfur content of the crude charge and side streams to determine the distribution of acids in the various cuts.
- c) Electrical resistance corrosion probes and corrosion coupon racks can be used.
- d) Streams can be monitored for Fe and Ni content to assess corrosion in the system.
- e) Hydrogen probes have also been reported to detect NAC.

#### **5.1.1.7.8      *Related Mechanisms***

Sulfidation is a competing and complimentary mechanism which must be considered in most situations with NAC. In cases where thinning is occurring, it is difficult to distinguish between NAC and sulfidation.

#### **5.1.1.7.9      *References***

1. Derungs, "Naphthenic Acid Corrosion - An Old Enemy of the Petroleum Industry," CORROSION, Vol. 12 No. 12, NACE International, Houston, TX, pp. 41.
2. J. Gutzeit, "Naphthenic Acid Corrosion," NACE Paper No. 156, CORROSION/76, NACE International, Houston, TX, 1976.
3. R. Piehl, "Naphthenic Acid Corrosion in Crude Distillation Units," Materials Performance, January, 1988.
4. B.E. Hopkinson and L. E. Penuela, "Naphthenic Acid Corrosion by Venezuelan Crudes," Paper No. 502, CORROSION/97, NACE International, Houston, TX, 1997.
5. M.J. Nugent and J.D. Dobis, "Experience with Naphthenic Acid Corrosion in Low TAN Crudes," Paper No. 577, CORROSION/98, NACE International, Houston, TX, 1998.
6. API RP 581, Risk-Based Inspection Technology, American Petroleum Institute, Washington, D.C., 2008.

**Table 5-2 – Alloys listed in approximate order of increasing resistance to NAC**

CS, 1.25C-0.5Mo, 2.25Cr-1Mo, 5Cr-0.5Mo, 12Cr 9Cr-1Mo, 304L SS, 321SS, 347 SS 316 SS 317 SS 6% Mo Alloys Alloy 625, Alloy 276
--



**Figure 5-19 – Erosion-corrosion damage due to NAC in a 10-inch 5Cr elbow in the outlet of a vacuum heater in a VDU.**



**Figure 5-20 – Severe NAC of 410 SS trays and bubble caps in the HVGO section of the vacuum tower fed by the vacuum heater in Figure 5-19.**

### **5.1.1.8 Phenol (Carbolic Acid) Corrosion**

#### **5.1.1.8.1 Description of Damage**

Corrosion of carbon steel can occur in plants using phenol as a solvent to remove aromatic compounds from lubricating oil feedstocks.

#### **5.1.1.8.2 Affected Materials**

In order of increasing resistance: carbon steel, 304L, 316L and Alloy C276.

#### **5.1.1.8.3 Critical Factors**

- a) Temperature, water content, alloy chemistry and velocity are the critical factors.
- b) Corrosion is usually minimal in the treating section when the temperature is below 250°F (121°C).
- c) Corrosion can occur in the recovery section where spent phenol is separated by vaporization.
- d) Sulfur and organic acids may lead to naphthenic acid attack and sulfidation in the hot extract circuit.
- e) Carbon steel and 304/304L stainless steel corrode rapidly in phenol service above 450°F (232°C).
- f) Dilute aqueous solutions (5-15% phenol) are very corrosive to the extract dryer condensers.
- g) High velocities may promote localized corrosion.

#### **5.1.1.8.4 Affected Units or Equipment**

Phenol extraction facilities in lubes plant.

#### **5.1.1.8.5 Appearance or Morphology of Damage**

- a) Corrosion will be in the form of general or localized corrosion of carbon steel.
- b) Localized loss in thickness due to erosion-corrosion may occur.
- c) Erosion-corrosion and/or condensation corrosion may be observed in tower overhead circuits.

#### **5.1.1.8.6 Prevention / Mitigation**

- a) Corrosion is best prevented through proper materials selection and control of phenol solvent chemistry.
- b) Overhead piping circuits should be designed for a maximum velocity of 30 fps in the recovery section.
- c) Recovery tower overhead temperatures should be maintained to at least 30°F (17°C) above the dew point.
- d) Type 316L stainless steel may be used in the top of the dry tower, phenol flash tower and various condenser shells and separator drums that handle phenol-containing water.
- e) Tubes and headers in extract furnaces should be 316L.
- f) Alloy C276 has been used in areas of high velocity or other locations where 316L is inadequate.

#### **5.1.1.8.7 Inspection and Monitoring**

- a) UT and RT to monitor for loss in thickness.
- b) ER corrosion probes and corrosion coupons have been used for corrosion monitoring.

#### **5.1.1.8.8 Related Mechanisms**

Not applicable.

**5.1.1.8.9      *References***

1. ASM Metals Handbook, "Corrosion in Petroleum Refining and Petrochemical Operations," Volume 13, ASM International, Materials Park, OH.



### 5.1.1.9 Phosphoric Acid Corrosion

#### 5.1.1.9.1 *Description of Damage*

Phosphoric acid is most often used as a catalyst in polymerization units. It can cause both pitting corrosion and localized corrosion of carbon steels depending on water content.

#### 5.1.1.9.2 *Affected Materials*

In order of increasing resistance: carbon steel, 304L SS, 316L SS and Alloy 20.

#### 5.1.1.9.3 *Critical Factors*

- a) Acid concentration, temperature and contaminants.
- b) Solid phosphoric acid catalysts are not corrosive to carbon steel unless free water is present. When water is present, severe corrosion of carbon steel may occur.
- c) Corrosion rates increase with increasing temperature.
- d) Corrosion can penetrate a 1/4-inch thick steel tube in eight hours.
- e) Most corrosion probably occurs during water washing operations at shutdowns.
- f) Contaminants, such as chlorides, can increase phosphoric acid corrosion.

#### 5.1.1.9.4 *Affected Units or Equipment*

- a) Piping and equipment in the polymerization unit where water mixes with catalyst.
- b) Corrosion is usually found in low velocity areas where there is little or no circulation such as piping manifolds, the bottom of kettle-type reboilers, partial penetration welds, and exchangers where there is sufficient residence time to permit the settling of acid droplets.

#### 5.1.1.9.5 *Appearance or Morphology of Damage*

General or localized thinning of carbon steel.

#### 5.1.1.9.6 *Prevention / Mitigation*

- a) Selective upgrading to corrosion resistant materials is the only option where water cannot be eliminated.
- b) Type 304L SS is satisfactory for phosphoric acid concentration of 100% up to about 120°F (49°C). Type 316L SS is required from 120°F to 225°F (49°C to 107°C).
- c) Type 316L SS and Alloy 20 are effective at concentrations up to 85% at boiling temperatures.

#### 5.1.1.9.7 *Inspection and Monitoring*

- a) UT and RT for loss of thickness.
- b) Sample iron in water from first column overhead receiver.
- c) Online corrosion monitoring using ER probes and/or corrosion coupons in the water draw from the first column overhead condenser and the reboiler.

#### 5.1.1.9.8 *Related Mechanisms*

Not applicable.

**5.1.1.9.9      *References***

1. R.A. White and E.F. Ehmke, "Materials Selection for Refineries and Associated Facilities," NACE International, Houston, TX.
2. NACE Course Book, "Corrosion Control in the Refining Industry," NACE International, Houston, TX, 1999.

### 5.1.1.10 Sour Water Corrosion (Acidic)

#### 5.1.1.10.1 Description of Damage

- a) Corrosion of steel due to acidic sour water containing H<sub>2</sub>S at a pH between 4.5 and 7.0. Carbon dioxide (CO<sub>2</sub>) may also be present.
- b) Sour waters containing significant amounts of ammonia, chlorides or cyanides may significantly affect pH but are outside the scope of this section.

#### 5.1.1.10.2 Affected Materials

- a) Primarily affects carbon steel.
- b) Stainless steels, copper alloys and nickel base alloys are usually resistant.

#### 5.1.1.10.3 Critical Factors

- a) H<sub>2</sub>S content, pH, temperature, velocity and oxygen concentration are all critical factors.
- b) The H<sub>2</sub>S concentration in the sour water is dependent on the H<sub>2</sub>S partial pressure in the gas phase as well as temperature and pH.
- c) At a given pressure, the H<sub>2</sub>S concentration in the sour water decreases as temperature increases.
- d) Increasing concentrations of H<sub>2</sub>S tend to decrease solution pH down to about 4.5. Streams with a pH below 4.5 indicate the presence of a strong acid which would be the main corrosion concern (see [5.1.1](#)).
- e) Above a pH of about 4.5, a protective, thin iron sulfide layer limits the corrosion rate.
- f) In some instances at a pH above 4.5, a thicker, porous sulfide film layer can form. This can promote pitting under sulfide deposits. Typically, this does not affect the general corrosion rate.
- g) Other contaminants have a significant affect on water pH. For example, HCl and CO<sub>2</sub> lower pH (more acidic). Ammonia significantly increases pH and is more often associated with alkaline sour water where the main concern is ammonia bisulfide corrosion (see [5.1.1.2](#)).
- h) The presence of air or oxidants may increase the corrosion and usually produces pitting or underdeposit attacks.

#### 5.1.1.10.4 Affected Units or Equipment

Acid sour water corrosion is a concern in overhead systems of FCC and coker gas fractionation plants with high H<sub>2</sub>S levels and low NH<sub>3</sub> levels.

#### 5.1.1.10.5 Appearance or Morphology of Damage

- a) Corrosion damage from acidic sour water is typically general thinning. However, localized corrosion or localized underdeposit attack can occur, especially if oxygen is present. Corrosion in CO<sub>2</sub> containing environments may be accompanied by carbonate stress corrosion cracking (see [5.1.2.5](#)).
- b) 300 Series SS are susceptible to pitting attack and may experience crevice corrosion and/or chloride stress corrosion cracking (see [4.5.1](#)).

#### 5.1.1.10.6 Prevention / Mitigation

- a) 300 Series SS can be used at temperatures below about 140°F (60°C) where Chloride Stress Corrosion Cracking (CSCC) is not likely.
- b) Copper alloys and nickel alloys are generally not susceptible to acid sour water corrosion. However, copper alloys are vulnerable to corrosion in environments with ammonia.

**5.1.1.10.7 Inspection and Monitoring**

- a) Evidence of locally thinned areas can be found using scanning ultrasonic thickness methods or profile radiography.
- b) For carbon steel, damage is usually in the form general thinning but may be highly localized to specific areas of high velocity or turbulence, typically where a water phase is condensing.
- c) Process and corrosion monitoring are important aspects of a well-developed program to minimize the effects of acidic sour water corrosion.
- d) The water draws of overhead accumulators should be monitored periodically to measure pH.
- e) Properly placed corrosion probes and corrosion coupons provide additional information on the rate and extent of potential damage.

**5.1.1.10.8 Related Mechanisms**

Other factors to consider in these environments include wet H<sub>2</sub>S damage (see [5.1.2.3](#)) and carbonate SCC. (see [5.1.2.5](#)).

**5.1.1.10.9 References**

1. Joerg Gutzeit, "Corrosion of Steel by Sulfides and Cyanides in Refinery Condensate Water," Materials Protection, December, 1968, p. 17-23.
2. R.H. Hausler and N.D. Coble, "Corrosion Control in Crude Unit Overhead Systems," Paper 42-72 at API 37th Midyear Meeting, May, 1972.
3. Bruce D. Craig, "The Nature of Sulfides Formed on Steel in an H<sub>2</sub>S-O<sub>2</sub> Environment," CORROSION Vol. 35, No. 3, March 1979, p. 136-138.
4. Dillon, C.P., "Corrosion Control in the Chemical Process Industries," MTI Publication No. 45, Second Edition, NACE International, Houston, TX, 1994.
5. Jones, Denny A., "Principles and Prevention of Corrosion," Prentice-Hall, Inc., NY, 1996.
6. Bruce D. Craig, "Sour-Gas Design Considerations," Society of Petroleum Engineers (SPE) Monograph Series, Monograph Volume 15, TX, 1993.

### 5.1.1.11 Sulfuric Acid Corrosion

#### 5.1.1.11.1 Description of Damage

Sulfuric acid promotes general and localized corrosion of carbon steel and other alloys. Carbon steel heat affected zones may experience severe corrosion.

#### 5.1.1.11.2 Affected Materials

In order of increasing resistance: carbon steel, 316L SS, Alloy 20, high silicon cast iron, high nickel cast iron, Alloy B-2 and Alloy C276.

#### 5.1.1.11.3 Critical Factors

- a) Acid concentration, temperature, alloy content, velocity, contamination and presence of oxidizers.
- b) [Figure 5-21](#) shows a plot of carbon steel corrosion rates as a function of sulfuric acid concentration and temperature.
- c) Carbon steel corrosion rates increase significantly if the flow velocity exceeds about 2 to 3 fps (0.6 to 0.9 m/s) or at acid concentrations below 65%.
- d) Mix points with water cause heat to be released and high corrosion rates can occur where the acid becomes diluted.
- e) The presence of oxidizers can greatly increase the corrosion rate.

#### 5.1.1.11.4 Affected Units or Equipment

- a) Sulfuric acid alkylation units and waste water treatment plants are affected.
- b) Areas of vulnerability in sulfuric acid alkylation units include reactor effluent lines, reboilers, deisobutanizer overhead systems and the caustic treating section ([Figure 5-22](#) and [Figure 5-23](#)).
- c) Acid usually ends up in the bottom of fractionation towers and reboilers where it becomes concentrated.

#### 5.1.1.11.5 Appearance or Morphology of Damage

- a) Mostly general in nature, but attacks carbon steel weld heat affected zones rapidly.
- b) Hydrogen grooving may occur in low flow or stagnant areas such as in storage tanks or rail cars.
- c) Sulfuric acid attacks slag left from welding.
- d) If the corrosion rate and velocity are high, there will be no scale.
- e) Corrosion of steel by dilute acid is usually in the form of overall metal loss or pitting and becomes more severe with increasing temperature and velocity.

#### 5.1.1.11.6 Prevention / Mitigation

- a) Corrosion is minimized through materials selection and proper operation within design velocities.
- b) Alloys such as Alloy 20, Alloy 904L and Alloy C-276 resist dilute acid corrosion and form a protective iron sulfate film on the surface.
- c) Acidified product streams can be washed with caustic to neutralize the acid.

#### 5.1.1.11.7 Inspection and Monitoring

- a) UT or RT inspection of turbulent zones and hottest areas.
- b) Corrosion monitoring with coupons and ER probes.

**5.1.1.11.8      *Related Mechanisms***

Not applicable.

**5.1.1.11.9      *References***

1. NACE Publication 5A151, Materials of Construction for Handling Sulfuric Acid, NACE International, Houston, TX, 1985.
2. Sheldon W. Dean and George D. Grab, "Corrosion of Carbon Steel by Concentrated Sulfuric Acid," NACE Paper No.147, NACE International, TX, 1984.
3. S. K. Brubaker, "Materials of Construction for Sulfuric Acid," Process Industries Corrosion—The Theory and Practice, NACE International, Houston, TX, pp. 243-258.
4. API RP 581, Risk-Based Inspection Technology, American Petroleum Institute, Washington, D.C., 2008.
5. NACE Course Book, "Corrosion Control in the Refining Industry," NACE International, Houston, TX, 1999.
6. NACE Standard RP0294, Design, Fabrication, and Inspection of Tanks for the Storage of Concentrated Sulfuric Acid and Oleum at Ambient Temperatures, NACE International, Houston, TX.

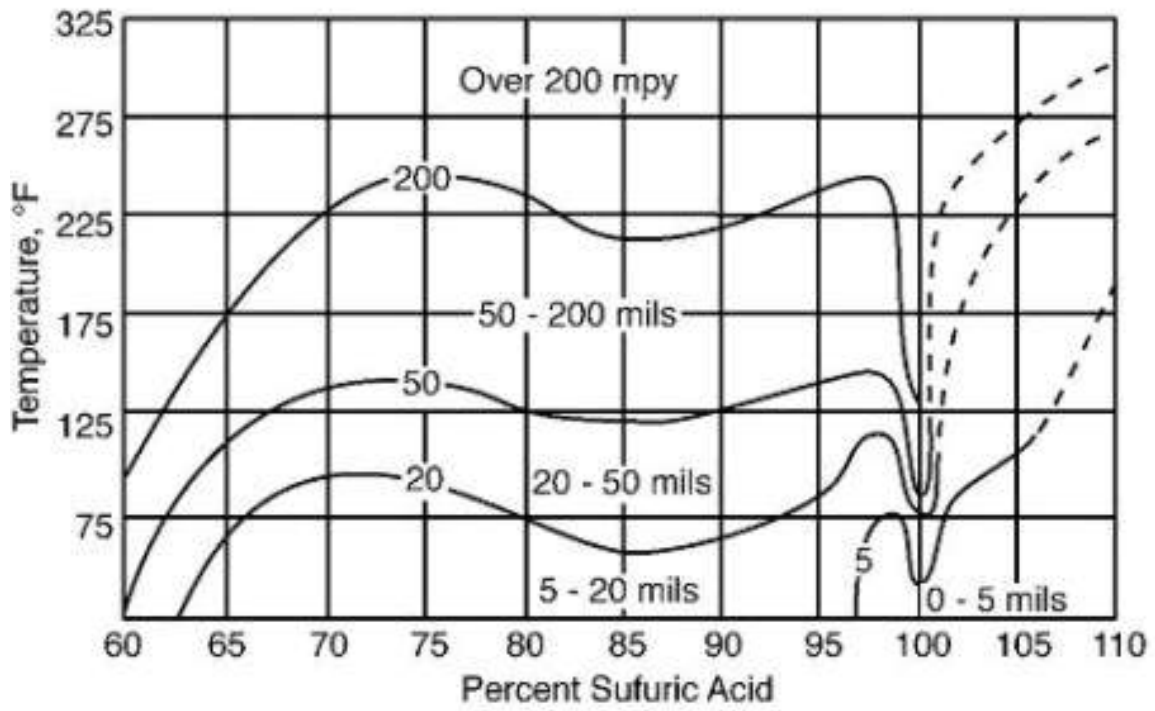


Figure 5-21 – Sulfuric acid corrosion data for carbon steel.



Figure 5-22 – Accelerated corrosion under a baffle.



**Figure 5-23 – Grooving corrosion in the carbon steel vapor line from an alkaline water wash drum in a sulfuric acid alkylation unit.**



### 5.1.1.12 Aqueous Organic Acid Corrosion

#### 5.1.1.12.1 Description of Damage.

Organic compounds present in some crude oils decompose in the crude furnace to form low molecular weight organic acids which condense in distillation tower overhead systems. They may also result from additives used in upstream operations or desalting. These naturally occurring acids may contribute significantly to aqueous corrosion depending on the type and quantity of acids, and the presence of other contaminants.

#### 5.1.1.12.2 Affected Materials

- a) All grades of carbon steel are affected.
- b) Most other corrosion resistant alloys used in crude tower overhead systems are generally not affected.

#### 5.1.1.12.3 Critical Factors

- a) Corrosion is a function of the type and quantity of organic acids, metal temperature, fluid velocity, system pH, and presence of other acids.
- b) The low molecular weight organic acids that are formed include formic acid, acetic acid, propionic acid, and butyric acid.
- c) The lower molecular weight acids such as formic acid and acetic acid are the most corrosive. They are soluble in naphtha and are extracted into the water phase, once the water condenses, and contribute to a reduction of pH.
- d) The presence of organic acids will contribute to the overall demand for neutralizing chemicals but their effects may be completely masked by the presence of other acids such as HCl, H<sub>2</sub>S, carbonic acid and others.
- e) Corrosion is most likely to be a problem where relatively 'non-corrosive' conditions exist in an overhead system and there is a sudden increase in low molecular weight organic acids that reduces the pH of the water in the overhead system requiring a potentially unexpected increase in neutralizer demand.
- f) The type and quantity of organic acids formed in the overhead system are crude specific. One source of acid is believed to be the result of thermal decomposition of naphthenic acids in the crude may be precursors to light organic acid formation and that processing of higher TAN crudes may increase organic acid in the overheads but very little published data is available on this subject.
- g) Some of the higher molecular weight organic acids condense above the water dew point in overhead systems but are generally not present in sufficient quantities to cause corrosion.
- h) Light organic acids such as acetic acid are sometimes added to upstream dehydrators or desalters to improve performance and inhibit calcium naphthenate salt deposition (Reference 2). Such acids will vaporize in the crude preheat and furnace, and go up the column into the crude tower overhead system.
- i) Other high molecular weight acids used as additives can thermally decompose at crude unit temperatures forming volatile acidic species, such as acetic and formic acids.
- j) In general, these light organic acids do not generate the severity of corrosion associated with inorganic acids such as HCl. Table 5-3 shows the HCl equivalent factor for corrosion in overhead systems. To calculate the HCl equivalent of an organic acid, multiply the content of the organic acid (in ppm-weight) by the factor for that acid, and result will be the equivalent content of HCl (in ppm). This number can then be used to estimate the neutralizer demand in the overhead system, and the additional neutralizer needed to compensate for organic acids in overhead systems. Excess neutralizer can lead to amine hydrochloride salts in overhead systems.

**5.1.1.12.4 Affected Units or Equipment**

- a) All carbon steel piping and process equipment in crude tower, vacuum tower and coker fractionator overhead systems including heat exchangers, towers and drums are susceptible to damage where acidic conditions occur.
- b) Corrosion tends to occur where water accumulates or where hydrocarbon flow directs water droplets against metal surfaces. For example, the bottoms of overhead exchangers, separator drums, boots of separator drums, elbows, tees, pumps, and downstream of control valves.
- c) Corrosion is also sensitive to flow rate and will tend to be more severe in turbulent areas in piping systems including overhead transfer lines, overhead condensers, separator drums, control valves, pipe elbows and tees, exchanger tubes, etc.

**5.1.1.12.5 Appearance or Morphology of Damage**

- a) Light organic acid corrosion typically leaves the corroded surface smooth and damage may be difficult to distinguish from corrosion by other acids in the overhead system. It is sometimes mistaken for HCl corrosion or carbonic acid corrosion.
- b) In pipe or other equipment where there is significant flow, the surfaces are sometimes smoothly grooved.

**5.1.1.12.6 Prevention / Mitigation**

- a) Corrosion caused by light organic acids in crude unit overhead systems can be minimized through the injection of a chemical neutralizing additive. However, problems may arise when frequent changes in crude blends lead to changes in neutralizer demand.
- b) The TAN of the crudes being processed can be used as an initial guide to setting the neutralizer by anticipating an increase in the acid concentration in the overhead system. After a new crude is processed, a review of analyses of water samples from the boot of the overhead separator drum can be used to determine how much light organic acid reaches the overhead system optimize future additions.
- c) Filming amines can be used to prevent corrosion if the filming amine selected does not react with the organic acid. However, using filming amines is not as effective as neutralization.
- d) Upgrading to corrosion-resistant alloys will prevent organic acid corrosion but the selection of suitable materials should account for other potential damage mechanisms in the overhead system.

**5.1.1.12.7 Inspection and Monitoring**

- a) UT and RT inspection for loss in thickness are the most common methods of inspection.
- b) Long range UT techniques can also be used for long runs of pipe.
- c) For carbon steel, damage is usually in the form of general thinning but may be highly localized where a water phase is condensing.
- d) Evidence of locally thinned areas can be found using automatic ultrasonic scanning methods or profile radiography.
- e) Process monitoring should include pH measurement and analysis of water in the crude tower overhead drum to analyze for the presence of organic acids.
- f) Strategically placed corrosion probes and/or corrosion coupons can provide additional information on the rate and extent of damage.

**5.1.1.12.8 Related Mechanisms**

This form of damage may be difficult to differentiate from HCl corrosion in crude tower overhead systems. See also HCl corrosion (see 5.1.1.4). Ammonium chloride corrosion (see 5.1.1.3), and chloride SCC (4.5.1).

**5.1.1.12.9      *References***

1. R. R. Petersen, "Improve Corrosion Control by Computer Simulation", Hydrocarbon Processing, January 1992, pp 50-55.
2. S. Kapusta, F. Rinus Daane, M.C. Place, "The Impact of Oil Field Chemicals on Refinery Corrosion Problems", NACE CORROSION/07, paper #03649, NACE International, Houston, TX, 2003.
3. S. Lordo, J.M. Garcia, S. Garcia-Swofford, "Desalter Acidification Additives and Their Potential Impacts on Crude Units", CORROSION 2008, paper 08556, NACE International, Houston, TX, 2008.
4. V.K. Braden, M. Malpiedi, L. Bowerbank, J. P. Gorman "Crude Unit Overhead Corrosion Control" NACE CORROSION/07, paper #98585, NACE International, Houston, TX, 1998.
5. NACE Publication 34109, "Crude Distillation Unit - Distillation Tower Overhead System Corrosion", NACE International, Houston, TX, January 2009.
6. J.R. Rue and D.P. Naeger, "Advances in Crude Unit Corrosion Control", NACE CORROSION/07, paper #199, NACE International, Houston, TX, 1997.
7. NACE International Publication 34105, "Effect of Nonextractable Chlorides on Refinery Corrosion and Fouling", NACE International, Houston, TX.

**Table 5-3 – Light Organic Acid Corrosion Equivalency Factors**

<b>Acid</b>	<b>HCl Equivalent Factor</b>
Formic	0.76
Acetic	0.61
Propionic	0.49
Methyl Propionic	0.41
Butanoic	0.41
3-Methyl Butanoic	0.36
Pentanoic	0.36
Hexanoic	0.31
Heptanoic	0.28

## 5.1.2 Environment-Assisted Cracking

### 5.1.2.1 Polythionic Acid Stress Corrosion Cracking (PASCC)

#### 5.1.2.1.1 *Description of Damage*

- a) A form of stress corrosion cracking normally occurring during shutdowns, startups or during operation when air and moisture are present. Cracking is due to sulfur acids forming from sulfide scale, air and moisture acting on sensitized austenitic stainless steels.
- b) Usually adjacent to welds or high stress areas.
- c) Cracking may propagate rapidly through the wall thickness of piping and components in a matter of minutes or hours.

#### 5.1.2.1.2 *Affected Materials*

300 Series SS, Alloy 600/600H and Alloy 800/800H.

#### 5.1.2.1.3 *Critical Factors*

- a) A combination of environment, material, and stress are required.
  - 1) Environment - Metallic components form a surface sulfide scale when exposed to sulfur compounds. The scale may react with air (oxygen) and moisture to form sulfur acids (polythionic acid).
  - 2) Material - The material must be in a susceptible or "sensitized" condition.
  - 3) Stress - Residual or applied.
- b) Affected alloys become sensitized during exposure to elevated temperatures during manufacture, welding or high temperature service. "Sensitization" refers to the composition/time/temperature dependent formation of chromium carbide in the grain boundaries of the metal. Sensitization occurs in the 750°F to 1500°F (400°C to 815°C) temperature range.
- c) The carbon content and the thermal history of the alloy have a significant effect on sensitization susceptibility. Regular and controlled carbon grades of stainless steels such as types 304/304H and 316/316H are particularly susceptible to sensitizing in the weld HAZ. Low carbon "L" grades (< 0.03% C) are less susceptible and usually can be welded without sensitizing. The L grades will not sensitize provided long term operating temperatures do not exceed about 750°F (399°C).
- d) Residual stresses in most components are usually sufficient to promote cracking.

#### 5.1.2.1.4 *Affected Units or Equipment*

- a) All units where sensitized alloys are used in sulfur-containing environments. Commonly damaged equipment includes heat exchanger tubes, furnace tubes and piping.
- b) Fired heaters burning oil, gas, coke and most other sources of fuel may be affected depending on sulfur levels in the fuel.
- c) Severe cases have been found in FCC units (air rings, plenums, slide valves, cyclone components, expansion joint bellows and piping).
- d) In hydroprocessing units (heater tubes, hot feed/effluent exchanger tubes, bellows).
- e) Crude and coker units (piping).
- f) Boilers and high temperature equipment exposed to sulfur-containing combustion products.

**5.1.2.1.5 Appearance or Morphology of Damage**

- a) Typically occurs next to welds, but can also occur in the base metal (Figure 5-24). It is usually quite localized and may not be evident until a leak appears during start-up or, in some cases, operation.
- b) Cracking propagates intergranularly (Figure 5-25).
- c) Corrosion or loss in thickness is usually negligible.

**5.1.2.1.6 Prevention / Mitigation**

- a) If equipment will be opened or exposed to air, preventive measures should be taken to minimize or eliminate PASCC include flushing the equipment with alkaline or soda ash solution to neutralize sulfur acids immediately after or during shutdown or purging with dry nitrogen or nitrogen/ammonia during the shutdown to prevent air exposure. Refer to guidelines in NACE RP0170.
- b) For furnaces, keep the firebox heated above the dewpoint to prevent acids from forming on heater tubes.
- c) Low carbon grades such as 304L/316L/317L provide some measure of improvement over controlled carbon grades. The L grades will sensitize if exposed more than several hours above about 1000°F (538°C) or long term above 750°F (400°C).
- d) Improved resistance to PASCC cracking can be achieved with modified versions of these alloys containing small amounts of Ti and Nb. Typically used are the chemically stabilized grades (austenitic stainless steel types 321 and 347 and nickel base Alloys 825 and 625).
- e) ASTM specifications allow mill products to be shipped in a stabilized condition rather than solution annealed. This heat treatment will minimize potential sensitization problems especially with type 321.
- f) A thermal stabilization heat treatment at 1650°F (899°C) may be applied to chemically stabilized austenitic stainless steel welds after all welding is complete in an attempt to reduce sensitization and PTA susceptibility. This heat treatment is difficult to apply in the field.
- g) Susceptibility to PASCC can be determined by laboratory corrosion testing according to ASTM A262 Practice C. A sensitizing heat treatment is often applied to L and/or chemically stabilized grades prior to testing.

**5.1.2.1.7 Inspection and Monitoring**

- a) PT examination can be used to detect PASCC cracking (Figure 5-24 through Figure 5-28). However, because the cracks are filled with a tight deposit, flapper disc sanding may be needed to improve the PT sensitivity.
- b) PASCC cracking can be an inspection challenge because the cracking may not occur until well into a turnaround.
- c) Monitoring for PASCC cracking during operation is not usually practical. Conditions causing the cracking are not usually present while operating.

**5.1.2.1.8 Related Mechanisms**

Also known as Polythionic Acid Stress Corrosion Cracking (PTA SCC), Intergranular Corrosion (IGC) and Intergranular Attack (IGA).

**5.1.2.1.9 References**

1. "Metals Handbook," Volume 13, CORROSION, ASM International, Materials Park, OH, pp. 327.
2. NACE Recommended Practice RP0170, Protection of Austenitic Stainless Steels and Other Austenitic Alloys from Polythionic Acid Stress Corrosion Cracking during Shutdown of Refinery Equipment, NACE International, Houston, TX.
3. D.V. Beggs, and R.W. Howe, "Effects of Welding and Thermal Stabilization on the Sensitization and Polythionic Acid Stress Corrosion Cracking of Heat and Corrosion-Resistant Alloys," CORROSION/93, Paper 541, NACE International, Houston, TX, 1993.
4. L. Scharfstein, "The Effect of Heat Treatments in the Prevention of Intergranular Corrosion Failures of AISI 321 Stainless Steel," Materials Performance, September 1983, pp. 22-24.
5. E. Lendvai-Linter, "Stainless Steel Weld Overlay Resistance to Polythionic Acid Attack," Materials Performance, Volume 18, No. 3, 1979, pp. 9.
6. J. E. Cantwell, "Embrittlement and Intergranular Stress Corrosion Cracking of Stainless Steels After Elevated Temperature Exposure in Refinery Process Units," Proceedings of API Division of Refining Midyear Meeting, May, 1984.
7. R.L. Piehl, "Stress Corrosion Cracking by Sulfur Acids," Proceedings of API Division of Refining, Volume 44 (III), 1964, pp. 189-197.
8. C.H. Samans, "Stress Corrosion Cracking Susceptibility of Stainless Steels and Nickel-Base Alloys in Polythionic Acids and Acid Copper Sulfate Solution," CORROSION, Volume 20, No. 8, NACE International, TX, 1994, pp. 256-262.
9. C.D. Stevens and R.C. Scarberry, "The Relation of Sensitization to Polythionic Acid Cracking of Incoloy Alloys 800 and 801", NACE Proceedings of the 25th Conference, NACE International, Houston, TX, 1969, pp. 583-586.
10. E. Nagashima, K. Matsumoto, and K. Shibata, "Effects of Sensitization and Service Fluid Chemistry on Polythionic Acid Stress Corrosion Cracking of 18-8 Stainless Steels", CORROSION/98, Paper 592, NACE International, Houston, TX, 1998.

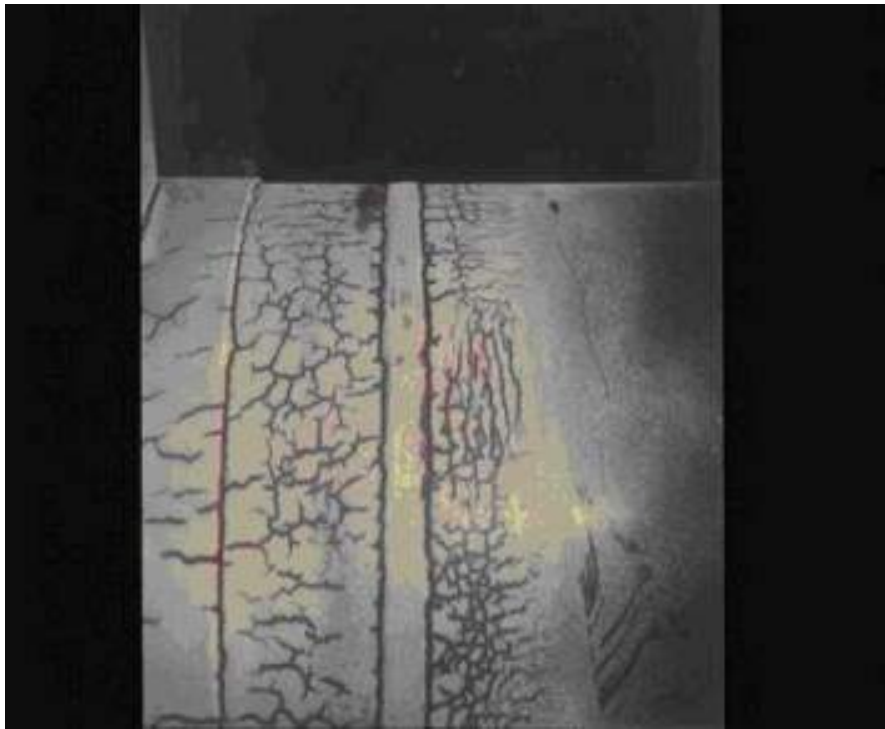


Figure 5-24 – Dye penetrant inspection showing extensive O.D. cracking around welds.

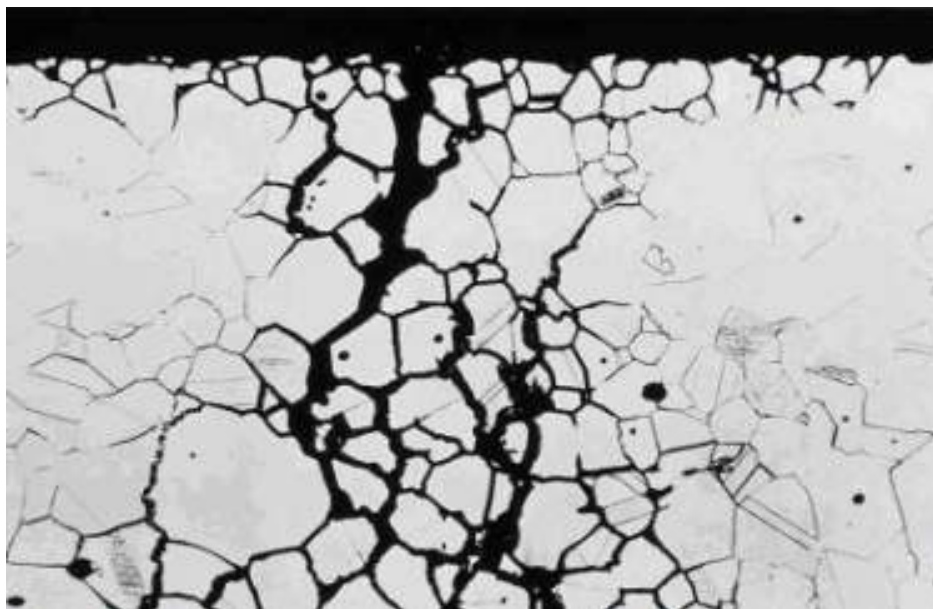
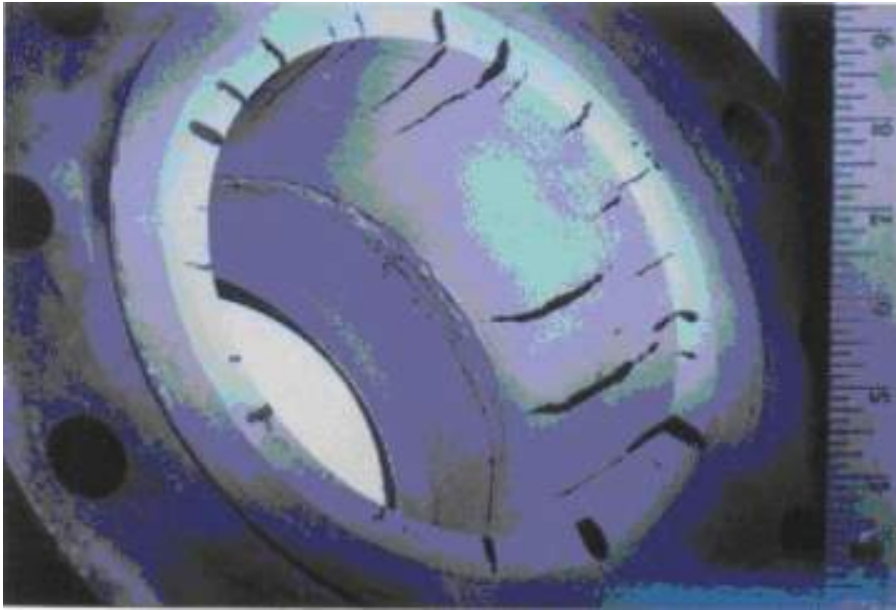
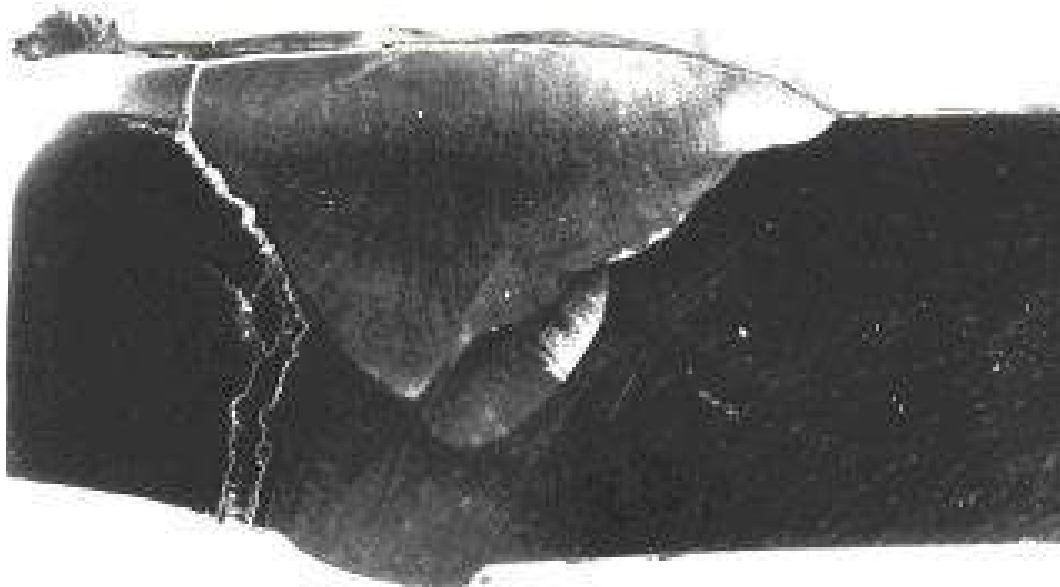


Figure 5-25 – High magnification photomicrograph of metallographic sample showing intergranular cracking and grain dropping.





**Figure 5-26 – PT inspection of a type 304 stainless steel catalyst withdrawal line piping and weld neck flange.**



**Figure 5-27 – Cross-section of the catalyst withdrawal line attached to the flange in Figure 5-26 showing cracking in the weld HAZ. Mag. 3X.**



**Figure 5-28 – Higher magnification view showing intergranular cracking. Mag. 200X.**

### 5.1.2.2 Amine Stress Corrosion Cracking

#### 5.1.2.2.1 Description of Damage

- a) Amine cracking is a common term applied to the cracking of steels under the combined action of tensile stress and corrosion in aqueous alkanolamine systems used to remove/absorb H<sub>2</sub>S and/or CO<sub>2</sub> and their mixtures from various gas and liquid hydrocarbon streams.
- b) Amine cracking is a form of alkaline stress corrosion cracking.
- c) It is most often found at or adjacent to non-PWHT'd carbon steel weldments or in highly cold worked parts.
- d) Amine cracking should not be confused with several other types of SCC that can occur in amine environments which are further described in [5.1.2.3](#) and [5.1.2.5](#).

#### 5.1.2.2.2 Affected Materials

Carbon steel and low alloy steels.

#### 5.1.2.2.3 Critical Factors

- a) The critical factors are the level of tensile stress, amine concentration and temperature.
- b) Cracking is associated with residual stresses from welding, cold working or fabrication that have not been removed through an effective stress-relieving heat treatment.
- c) Cracking is more likely to occur in lean MEA and DEA services but is also found in most amines including MDEA and DIPA (ADIP).
- d) Cracking has been reported down to ambient temperatures with some amines. Increasing temperature and stress levels increases the likelihood and severity of cracking. Refer to API RP 945 for guidelines on PWHT requirements for various amine services.
- e) Amine cracking is most often associated with lean amine services. The pure alkanolamine does not cause cracking. Cracking in rich amine services are most often associated with wet H<sub>2</sub>S problems (see [5.1.2.3](#)).
- f) Cracking can occur in non-PWHT'd piping and equipment as a result exposure to steamout and to short-term amine carryover.
- g) Amine concentration does not appear to have a significant effect on the propensity for cracking.
- h) Some refiners believe cracking will not occur below an amine concentration of about 2% to 5%. However, local enrichment and steamout can reduce this limit and some plants have used lower limits down to 0.2%.

#### 5.1.2.2.4 Affected Units or Equipment

All non-PWHT carbon steel piping and equipment in lean amine service including contactors, absorbers, strippers, regenerators and heat exchangers as well as any equipment subject to amine carryover.

#### 5.1.2.2.5 Appearance or Morphology of Damage

- a) Amine cracking results in surface breaking flaws that initiate on the ID of piping and equipment primarily in the weld HAZ but has also been found in weld metal and high stress areas adjacent to the HAZ.
- b) Cracking typically develops parallel to the weld and there may be parallel cracks. In weld metal, the cracks are either transverse or longitudinal with the weld.
- c) At set-on nozzles, the cracks are radial in the base metal, i.e., they fan out from the bore. At set-in nozzles, the cracks are usually parallel to the weld.

- d) The appearance of the cracks on the surface may be similar to those caused by wet H<sub>2</sub>S cracking.
- e) Since the driving force for cracking is residual stress, cracks are often found on the process side, opposite external attachment welds.
- f) Positive identification of amine cracking can be confirmed by metallographic analysis. The cracking is typically intergranular, oxide filled with some branching (Figure 5-29 through Figure 5-32).

#### **5.1.2.2.6      *Prevention / Mitigation***

- a) PWHT all carbon steel welds in piping and equipment in accordance with API RP 945. The same requirement applies to repair welds and to internal and external attachment welds (Figure 5-33).
- b) Use solid or clad stainless steel, Alloy 400 or other corrosion resistant alloys in lieu of carbon steel.
- c) Water wash non-PWHT carbon steel piping and equipment prior to welding, heat treatment or steamout.

#### **5.1.2.2.7      *Inspection and Monitoring***

- a) Although cracks may be seen visually, crack detection is best performed with WFMT or ACFM techniques. Surface preparation by grit blasting, high pressure water blasting or other methods is required for WFMT but may not be necessary for ACFM.
- b) PT is usually not effective in finding tight and/or scale filled cracks and should not be used.
- c) If the cracks have minimum branching, crack depths can be measured with a suitable UT technique including external SWUT.
- d) AET can also be used for monitoring crack growth and locating growing cracks.

#### **5.1.2.2.8      *Related Mechanisms***

Amine cracking is more properly termed amine stress corrosion cracking and is a form of Alkaline Stress Corrosion Cracking (ASCC). Caustic stress corrosion cracking (see 4.5.3) and carbonate stress corrosion cracking (see 5.1.2.5) are two other forms of ASCC that are similar in appearance.

#### **5.1.2.2.9      *References***

1. API Recommended Practice 945, Avoiding Environmental Cracking in Amine Units, American Petroleum Institute, Washington, D.C.
2. "Fitness-For-Service Evaluation Procedures for Operating Pressure Vessels, Tanks, and Piping in Refinery and Chemical Service." Materials Properties Council, FS-26, Draft No. 5, Consultants Report, NY, 1995.
3. J. Gutzeit and J.M. Johnson, "Stress Corrosion Cracking of Carbon Steel Welds in Amine Service," Materials Performance, Vol. 25, No.7, 1986, p.18.
4. J.P. Richert et al, "Stress Corrosion Cracking of Carbon Steel in Amine Systems," Paper No. 187, CORROSION/87, NACE International, Houston, TX, 1987.
5. Bagdasarian et al, "Stress Corrosion Cracking of Carbon Steel in DEA and ADIP Solutions," Materials Performance, 1991, pp. 63-67.

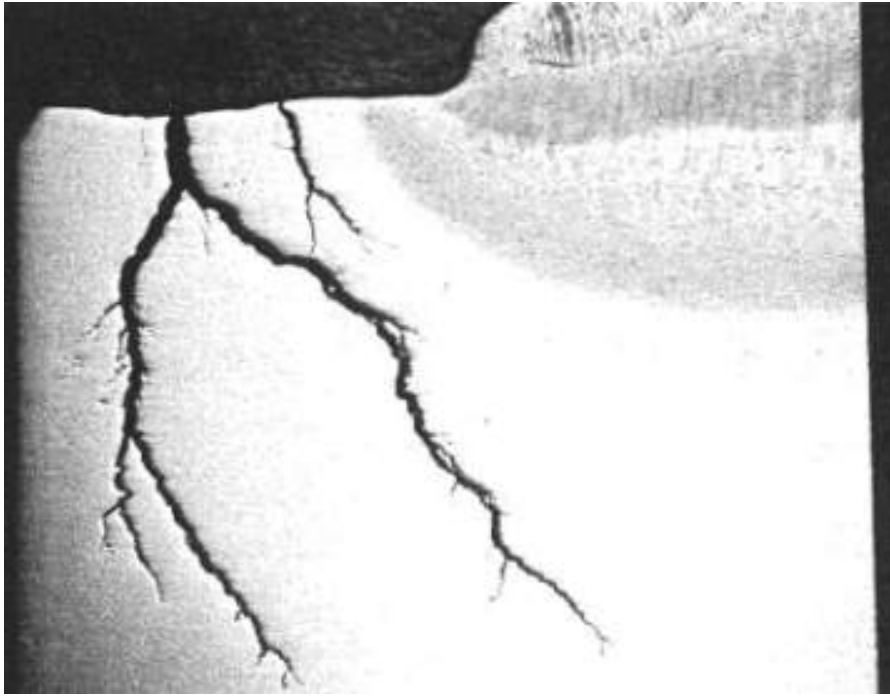


Figure 5-29 – A photomicrograph of a cross-section of a weld in non-PWHT piping showing a SCC in the vicinity of a piping weld. Mag. 6X (From API 945)

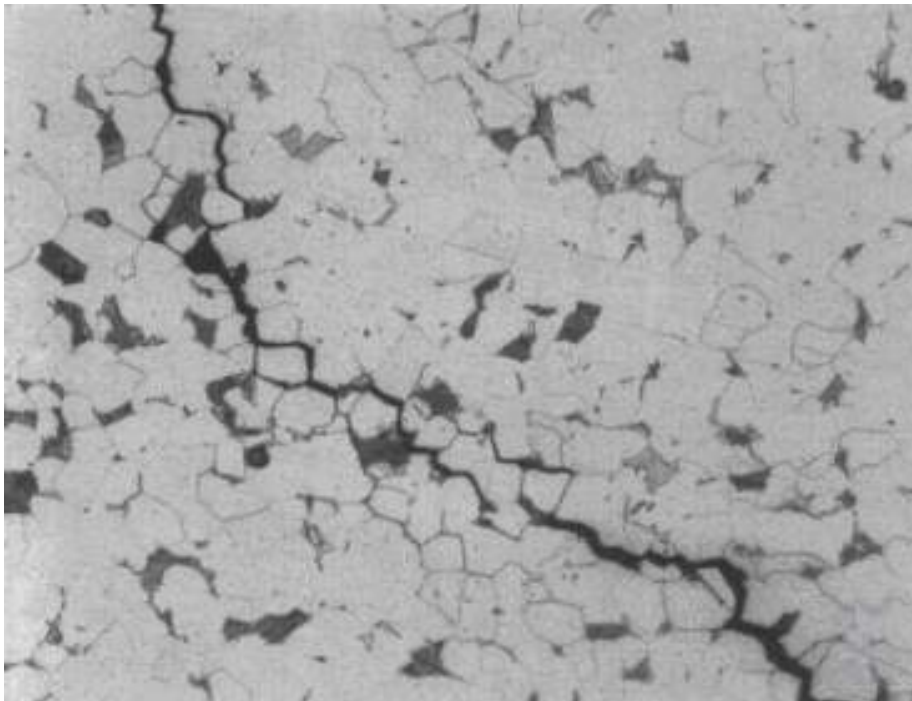
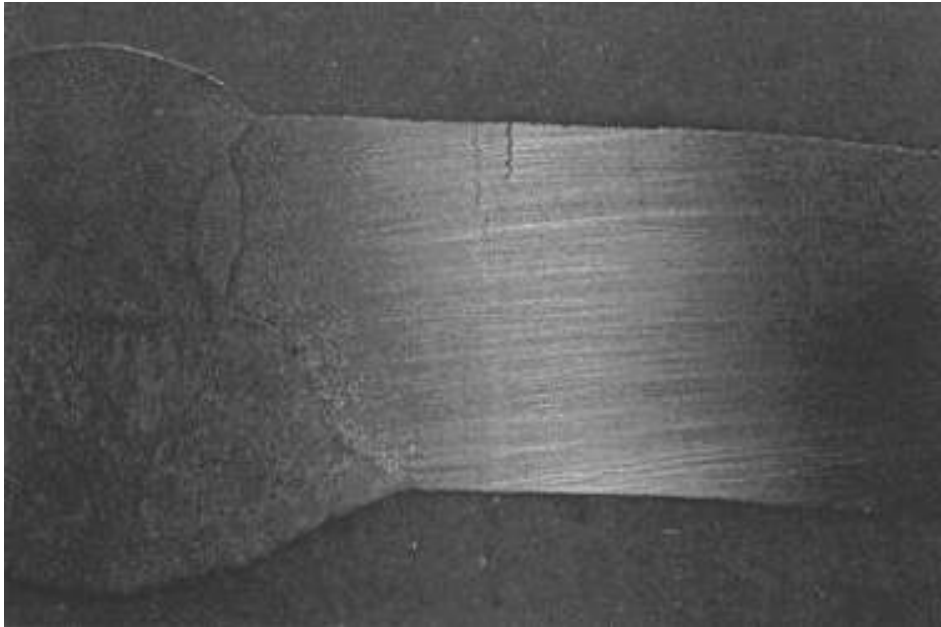
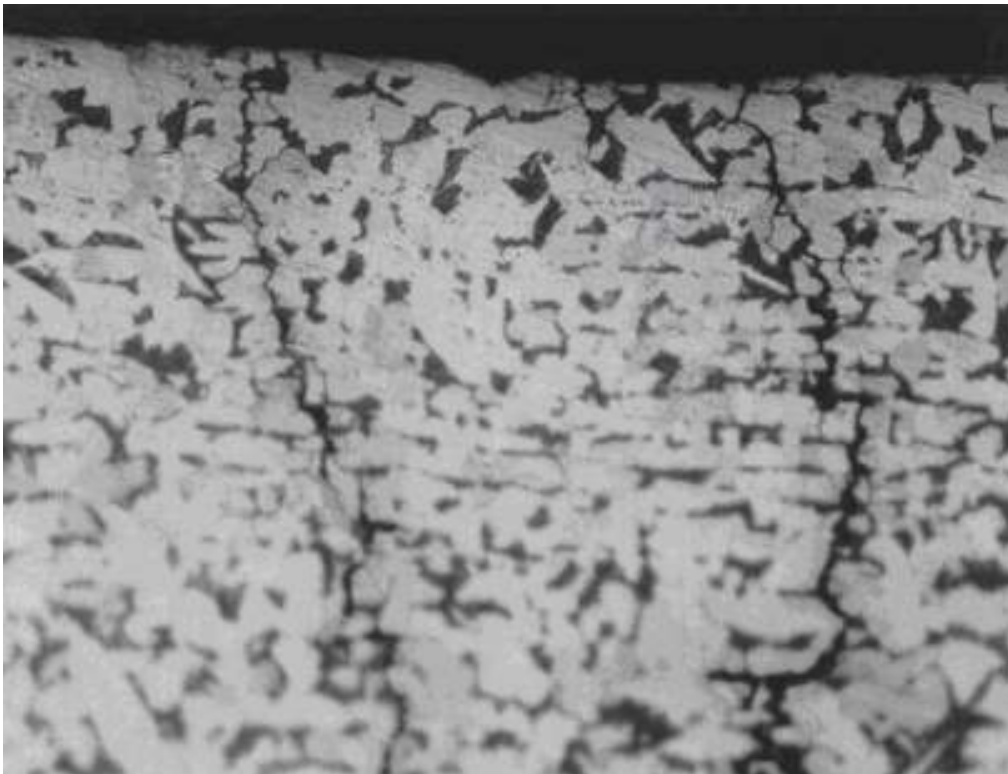


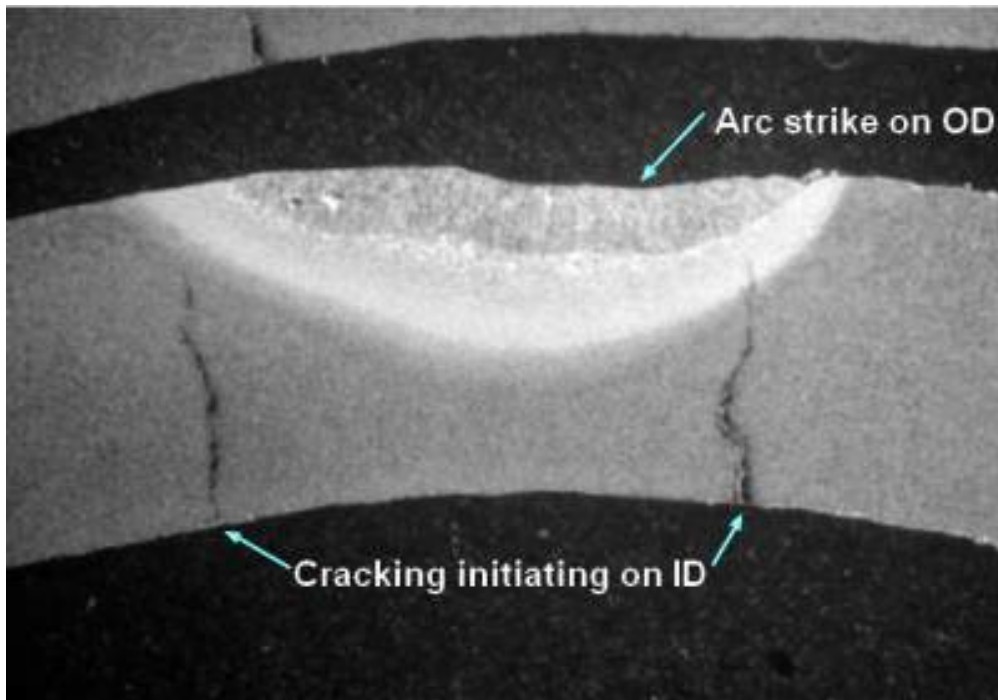
Figure 5-30 – A higher magnification view of the crack tip in Figure 5-29. Mag. 200X. (From API RP 945.)



**Figure 5-31 – A photomicrograph of a cross-section of a piping weld showing stress corrosion cracking in section of the line from the MEA absorber column normally operated at 100°F (38°C). Mag. 6X. (From API RP 945.)**



**Figure 5-32 – A higher magnification view of the cracks in Figure 5-31 which illustrates the intergranular nature of cracking. Mag. 200X. (From API RP 945.)**



**Figure 5-33 – Amine SCC developed on the ID, beneath an arc strike on the OD of a 3 inch line in 20% MEA. The original line was PWHT'd during original fabrication but not the arc strike. Leaks occurred after 30 years service.**

### 5.1.2.3 Wet H<sub>2</sub>S Damage (Blistering/HIC/SOHIC/SSC)

#### 5.1.2.3.1 *Description of Damage*

This section describes four types of damage that result in blistering and/or cracking of carbon steel and low alloy steels in wet H<sub>2</sub>S environments.

a) Hydrogen Blistering

Hydrogen blisters may form as surface bulges on the ID, the OD or within the wall thickness of a pipe or pressure vessel. The blister results from hydrogen atoms that form during the sulfide corrosion process on the surface of the steel, that diffuse into the steel, and collect at a discontinuity in the steel such as an inclusion or lamination. The hydrogen atoms combine to form hydrogen molecules that are too large to diffuse out and the pressure builds to the point where local deformation occurs, forming a blister. Blistering results from hydrogen generated by corrosion, not hydrogen gas from the process stream. (Figure 5-34 and Figure 5-35.)

b) Hydrogen Induced Cracking (HIC)

Hydrogen blisters can form at many different depths from the surface of the steel, in the middle of the plate or near a weld. In some cases, neighboring or adjacent blisters that are at slightly different depths (planes) may develop cracks that link them together. Interconnecting cracks between the blisters often have a stair step appearance, and so HIC is sometimes referred to as “stepwise cracking” (Figure 5-36, Figure 5-37 and Figure 5-38).

c) Stress Oriented Hydrogen Induced Cracking (SOHIC)

SOHIC is similar to HIC but is a potentially more damaging form of cracking which appears as arrays of cracks stacked on top of each other. The result is a through-thickness crack that is perpendicular to the surface and is driven by high levels of stress (residual or applied). They usually appear in the base metal adjacent to the weld heat affected zones where they initiate from HIC damage or other cracks or defects including sulfide stress cracks (Figure 5-39 and Figure 5-40).

d) Sulfide Stress Cracking (SSC)

Sulfide Stress Cracking (SSC) is defined as cracking of metal under the combined action of tensile stress and corrosion in the presence of water and H<sub>2</sub>S. SSC is a form of hydrogen stress cracking resulting from absorption of atomic hydrogen that is produced by the sulfide corrosion process on the metal surface.

SSC can initiate on the surface of steels in highly localized zones of high hardness in the weld metal and heat affected zones. Zones of high hardness can sometimes be found in weld cover passes and attachment welds which are not tempered (softened) by subsequent passes. PWHT is beneficial in reducing the hardness and residual stresses that render steel susceptible to SSC. High strength steels are also susceptible to SSC but these are only used in limited applications in the refining industry. (Figure 5-42 and Figure 5-43). Some carbon steels contain residual elements that form hard areas in the heat affected zones that will not temper at normal stress relieving temperatures. Using preheat helps minimize these hardness problems.

#### 5.1.2.3.2 *Affected Materials*

Carbon steel and low alloy steels.

#### 5.1.2.3.3 *Critical Factors*

- a) The most important variables that affect and differentiate the various forms of wet H<sub>2</sub>S damage are environmental conditions (pH, H<sub>2</sub>S level, contaminants, temperature), material properties (hardness, microstructure, strength) and tensile stress level (applied or residual). These factors are outlined below.



- b) All of these damage mechanisms are related to the absorption and permeation of hydrogen in steels.
- 1) pH
    - Hydrogen permeation or diffusion rates have been found to be minimal at pH 7 and increase at both higher and lower pH. The presence of hydrogen cyanide (HCN) in the water phase significantly increases permeation in alkaline (high pH) sour water.
    - Conditions which are known to promote blistering, HIC, SOHIC and SSC are those containing free water (in liquid phase) and:
      - >50 wppm dissolved H<sub>2</sub>S in the free water, or
      - free water with pH <4 and some dissolved H<sub>2</sub>S present, or
      - free water with pH >7.6 and 20 wppm dissolved hydrogen cyanide (HCN) in the water and some dissolved H<sub>2</sub>S present, or
      - >0.0003 MPa (0.05 psia) partial pressure of H<sub>2</sub>S in the gas phase.
    - Increasing levels of ammonia may push the pH higher into the range where cracking can occur.
  - 2) H<sub>2</sub>S
    - Hydrogen permeation increases with increasing H<sub>2</sub>S partial pressure due to a concurrent increase in the H<sub>2</sub>S concentration in the water phase.
    - An arbitrary value of 50 wppm H<sub>2</sub>S in the water phase is often used as the defining concentration where wet H<sub>2</sub>S damage becomes a problem. However, there are cases where cracking has occurred at lower concentrations or during upset conditions where wet H<sub>2</sub>S was not ordinarily anticipated. The presence of as little as 1 wppm of H<sub>2</sub>S in the water has been found to be sufficient to cause hydrogen charging of the steel.
    - Susceptibility to SSC increases with increasing H<sub>2</sub>S partial pressures above about 0.05 psi (0.0003 Mpa) H<sub>2</sub>S in steels with a tensile strength above about 90 ksi or in steels with localized zones of weld or weld HAZ hardness above 237 HB.
  - 3) Temperature
    - Blistering, HIC, and SOHIC damage have been found to occur between ambient and 300°F (150°C) or higher.
    - SSC generally occurs below about 180°F (82°C). However, equipment operating above this temperature are susceptible to SSC if there is an aqueous phase with H<sub>2</sub>S as outlined above. Some susceptible equipment can fail even during short sour water excursions such as those encountered during equipment shutdowns.
    - Hydrogen charging potential increases with increasing temperature if the aqueous phase is not eliminated by elevated temperature. Elevated temperature promotes dissociation of H<sub>2</sub>S (thereby producing more monatomic hydrogen), together with an increase in the diffusion rates of hydrogen in metals, resulting in increased level of hydrogen charging. However, the SSC cracking potential is maximized at near-ambient temperature. This distinction is important because metals can become charged during high-temperature exposure and subsequently crack during excursions to lower temperatures (Reference 8).
  - 4) Hardness
    - Hardness is primarily an issue with SSC. Typical low-strength carbon steels used in refinery applications should be controlled to produce weld hardness <200 HB in accordance with NACE RP0472. These steels are not generally susceptible to SSC unless localized zones of hardness above 237 HB are present.
    - The time to failure by SSC decreases as material strength, applied tensile stress, and environmental charging potential increase.

- Blistering, HIC and SOHIC damage are not related to steel hardness.
- 5) Steelmaking
- Blistering and HIC damage are strongly affected by the presence of inclusions and laminations which provide sites for diffusing hydrogen to accumulate.
  - Steel chemistry and manufacturing methods also affect susceptibility and can be tailored to produce the HIC resistant steels outlined in NACE Publication 8X194.
  - Improving steel cleanliness and processing to minimize blistering and HIC damage may still leave the steel susceptible to SOHIC.
  - The disadvantage is that an absence of visual blistering may leave a false sense of security that H<sub>2</sub>S damage is not active yet subsurface SOHIC damage may be present.
  - HIC is often found in so-called “dirty” steels with high levels of inclusions or other internal discontinuities from the steel-making process.
- 6) PWHT
- Blistering and HIC damage develop without applied or residual stress so that PWHT will not prevent them from occurring.
  - High local stresses or notch-like discontinuities such as shallow sulfide stress cracks can serve as initiation sites for SOHIC. PWHT is highly effective in preventing or eliminating SSC by reduction of both hardness and residual stress.
  - SOHIC is driven by localized stresses so that PWHT is also somewhat effective in reducing SOHIC damage.

#### 5.1.2.3.4 *Affected Units or Equipment*

- a) Blistering, HIC, SOHIC and SSC damage can occur throughout the refinery wherever there is a wet H<sub>2</sub>S environment present.
- b) In hydroprocessing units, increasing concentration of ammonium bisulfide above 2% increases the potential for blistering, HIC and SOHIC.
- c) Cyanides significantly increase the probability and severity of blistering, HIC and SOHIC damage. This is especially true for the vapor recovery sections of the fluid catalytic cracking and delayed coking units. Typical locations include fractionator overhead drums, fractionation towers, absorber and stripper towers, compressor interstage separators and knockout drums and various heat exchangers, condensers, and coolers. Sour water stripper and amine regenerator overhead systems are especially prone to wet H<sub>2</sub>S damage because of generally high ammonia bisulfide concentrations and cyanides.
- d) SSC is most likely found in hard weld and heat affected zones and in high strength components including bolts, relief valve springs, 400 Series SS valve trim, compressor shafts, sleeves and springs.

#### 5.1.2.3.5 *Appearance or Morphology of Damage*

- a) All four forms of wet H<sub>2</sub>S damage are best illustrated though the pictures and diagrams shown in [Figure 5-34](#) through [Figure 5-43](#).
- b) Hydrogen blisters appear as bulges on the ID or OD surface of the steel and can be found anywhere in the shell plate or head of a pressure vessel. Blistering has been found on rare occasions in pipe and very rarely in the middle of a weld. HIC damage can occur wherever blistering or subsurface laminations are present.
- c) In pressure-containing equipment, SOHIC and SSC damage is most often associated with the weldments. SSC can also be found at any location where zones of high hardness are found in vessels or in high strength steel components.

**5.1.2.3.6 Prevention / Mitigation**

- a) Effective barriers that protect the surface of the steel from the wet H<sub>2</sub>S environment can prevent damage including alloy cladding and coatings.
- b) Process changes that affect the pH of the water phase and/or ammonia or cyanide concentration can help to reduce damage. A common practice is to utilize wash water injection to dilute the HCN concentration, for example, in FCC gas plants. Cyanides can be converted to harmless thiocyanates by injecting dilute streams of ammonium polysulfides. Injection facilities require careful design.
- c) HIC-resistant steels can be used to minimize the susceptibility to blistering and HIC damage. Detailed materials and fabrication guidance can be found in NACE Publication 8X194.
- d) SSC can generally be prevented by limiting the hardness of welds and heat affected zones to 200 HB maximum through preheat, PWHT, weld procedures and control of carbon equivalents. Depending on the service environment, small zones of hardness up to 22 HRC should be resistant to SSC. Refer to NACE RP0472 for additional details.
- e) PWHT can also help to minimize susceptibility to SOHIC. PWHT has limited value in preventing blistering and HIC damage from initiating but is beneficial in reducing residual stresses and strength levels that might otherwise contribute to crack propagation.
- f) Specialized corrosion inhibitors can be used.

**5.1.2.3.7 Inspection and Monitoring**

- a) Process conditions should be evaluated by process engineers and corrosion/materials specialists to identify piping and equipment where conditions are most likely to promote wet H<sub>2</sub>S damage. Field sampling of the free water phase should be performed on a periodic or as-needed basis to monitor conditions or changes in conditions, particularly if water washing or polysulfide injection is used.
- b) Inspection for wet H<sub>2</sub>S damage generally focuses on weld seams and nozzles. Since the consequences can be severe, refineries generally have a procedure to prioritize and execute inspection for this type of damage. General notes on inspection for wet H<sub>2</sub>S damage are included below. However, for the development of more detailed inspection plans including methods, coverage and surface preparation, the reader is directed to extensive recommendations on detection and repair outlined in NACE RP0296.
- c) Although cracks may be seen visually, crack detection is best performed with WFMT, EC, RT or ACFM techniques. Surface preparation by grit blasting, high pressure water blasting or other methods is usually required for WFMT but not for ACFM. PT cannot find tight cracks and should not be depended on.
- d) UT techniques including external SWUT can be used. SWUT is especially useful for volumetric inspection and crack sizing. Electrical resistance instruments are not effective for measuring crack depth.
- e) Grinding out the crack or removal by thermal arc gouging is a viable method of crack depth determination.
- f) AET can be used for monitoring crack growth.

**5.1.2.3.8 Related Mechanisms**

- a) SSC is a form of hydrogen stress cracking (hydrogen embrittlement). Refer to [4.5.6](#).
- b) Amine cracking (see [5.1.2.2](#)) and carbonate cracking (see [5.1.2.5](#)) can also occur in wet H<sub>2</sub>S environments, may be similar in appearance, and are sometimes confused with the various forms of wet H<sub>2</sub>S damage.

**5.1.2.3.9      References**

1. NACE Standard RP0296, Guidelines for Detection, Repair and Mitigation of Cracking of Existing Petroleum Refinery Pressure Vessels in Wet H<sub>2</sub>S Environments, NACE International, Houston, TX.
2. MPC Report FS-26, Fitness-For Service Evaluation Procedures for Operating Pressure Vessels, Tanks, and Piping in Refinery and Chemical Service, Draft 5, October 1995, Materials Properties Council, NY, 1995.
3. G.M. Buchheim, "Ways to Deal With Wet H<sub>2</sub>S Cracking Revealed by Study," Oil and Gas Journal, July 9, 1990, pp. 92-96.
4. R.B. Nielson et al, "Corrosion in Refinery Amine Systems," Paper No. 571, CORROSION/95, NACE International, Houston, TX, 1995.
5. NACE Standard RP0472, Methods and Controls to Prevent in-Service Environmental Cracking of Carbon Steel Weldments in Corrosive Petroleum Refining Environments, NACE International, Houston, TX.
6. NACE Publication 8X194, Materials and Fabrication Practices for New Pressure Vessels used in Wet H<sub>2</sub>S Refinery Service, NACE International, Houston, TX.
7. R.D. Kane, R.J. Horvath, and M.S. Cayard, editors, "Wet H<sub>2</sub>S Cracking of Carbon Steels and Weldments," NACE International, Houston, TX, 1996.
8. NACE Standard MR0103, Materials Resistant to Sulfide Stress Cracking in Corrosive Petroleum Refining Environments, NACE International, Houston, TX.

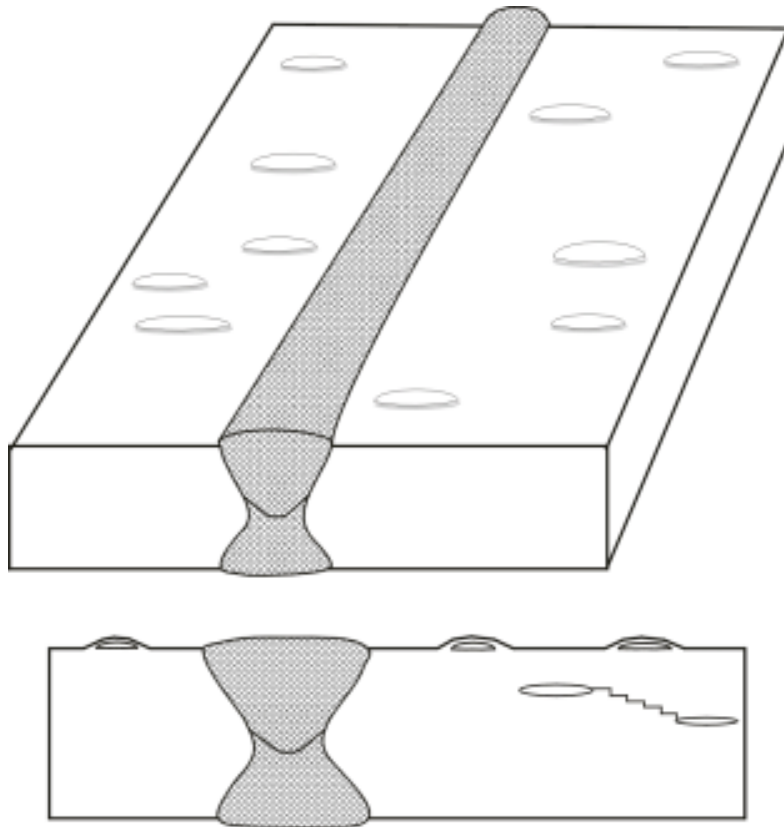


Figure 5-34 – Schematic of hydrogen blistering and HIC damage.

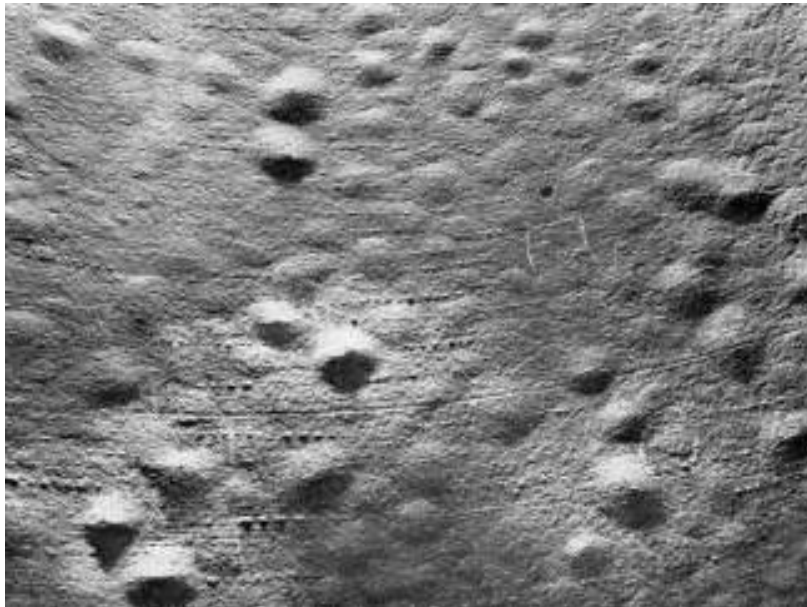
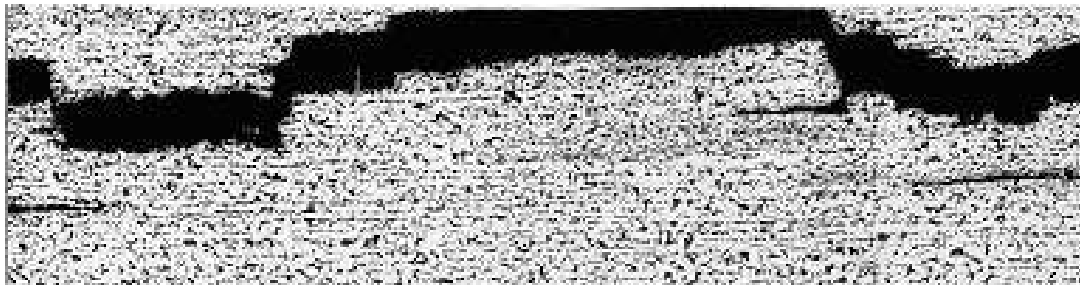


Figure 5-35 – Extensive hydrogen blistering on the surface of steel pressure vessel.



**Figure 5-36 – Cross-section of plate showing HIC damage in the shell of a trim cooler which had been cooling vapors off a HHPs vessel in a hydroprocessing unit.**



**Figure 5-37 – High magnification photomicrograph of HIC damage.**



Figure 5-38 – High magnification photomicrograph showing stepwise cracking nature of HIC damage.

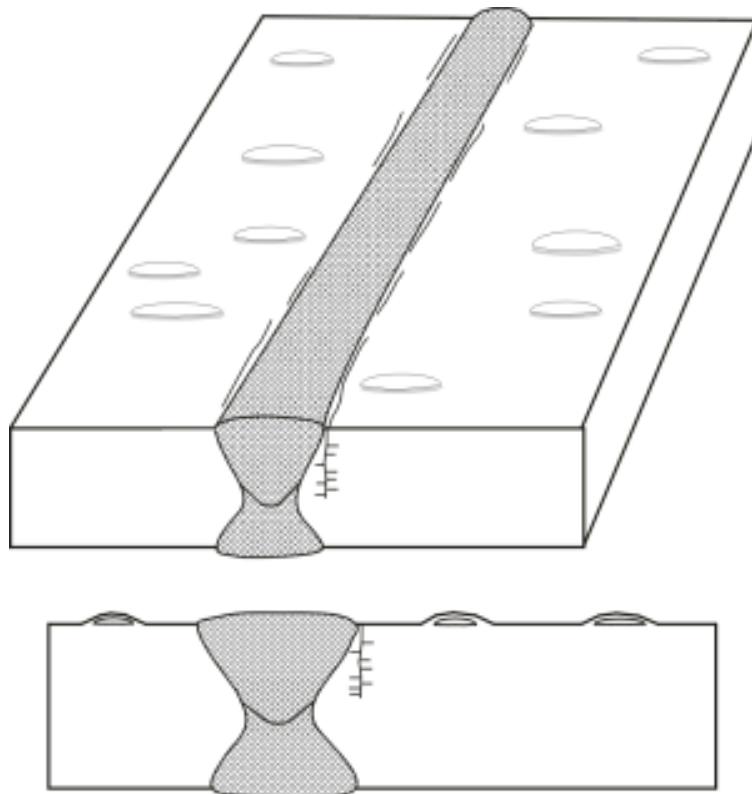


Figure 5-39 – Schematic showing hydrogen blistering that is accompanied by SOHIC damage at the weld.

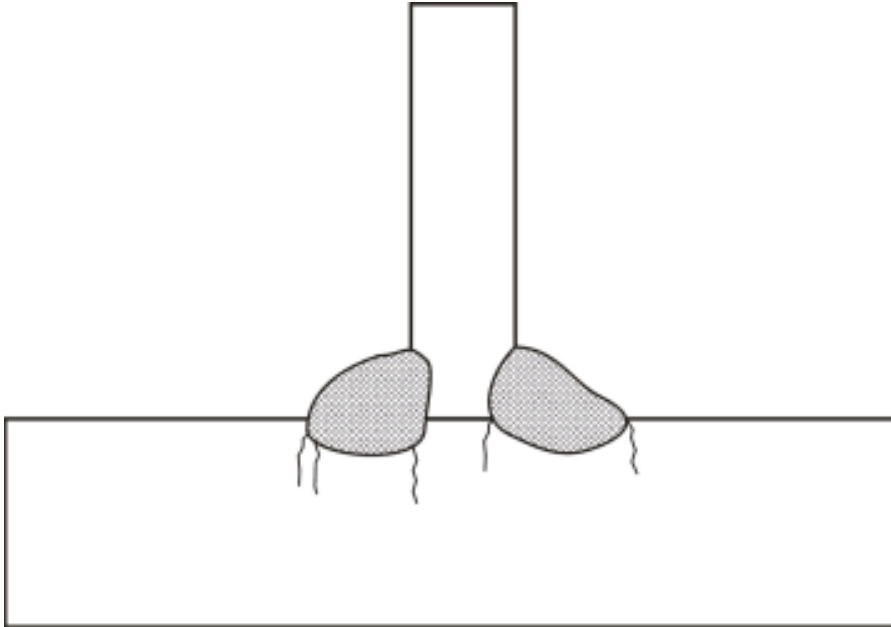


Figure 5-40 – Schematic of SOHIC damage at a fillet weld that is usually a combination of SSC and SOHIC.



Figure 5-41 – Photograph showing WFMT of SOHIC damage.



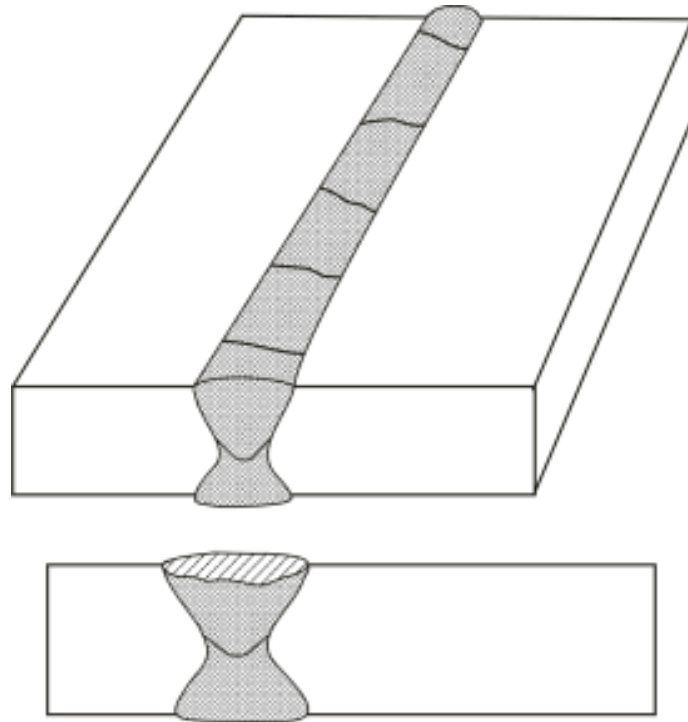


Figure 5-42 – Schematic of SSC damage of a hard weld.

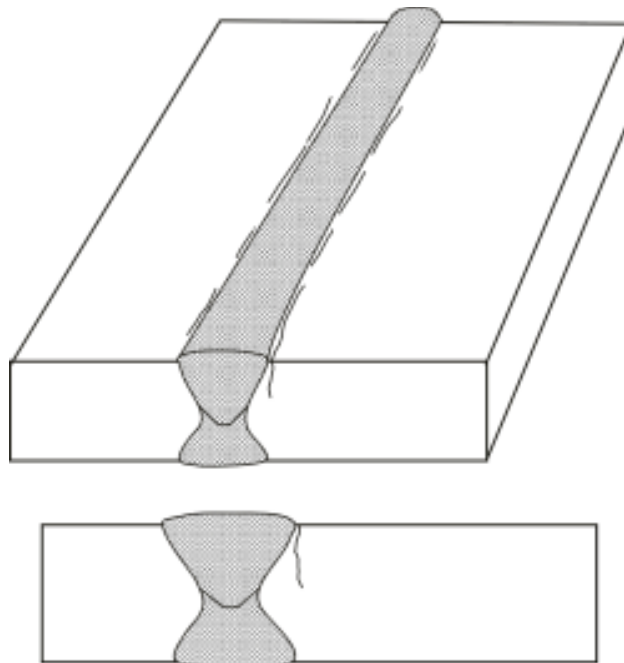


Figure 5-43 – Schematic showing morphology of sulfide stress cracking in a hard heat affected zone.

### 5.1.2.4 Hydrogen Stress Cracking - HF

#### 5.1.2.4.1 *Description of Damage*

Hydrogen Stress Cracking is a form of environmental cracking that can initiate on the surface of high strength low alloy steels and carbon steels with highly localized zones of high hardness in the weld metal and HAZ as a result of exposure to aqueous HF acid environments.

#### 5.1.2.4.2 *Affected Materials*

Carbon steel and low alloy steels.

#### 5.1.2.4.3 *Critical Factors*

- a) Steel hardness, strength and stress are the critical factors.
- b) Susceptibility increases with increasing hardness. Hardness levels above Rockwell C 22 (237 BHN) are highly susceptible. Time-to-failure decreases as the hardness increases (higher strength materials).
- c) Under high levels of applied or residual tensile stress (from cold-forming or welding) embrittlement results in cracking of susceptible steels.
- d) Cracking may occur very rapidly, within hours after exposure to the HF environment, or considerable time may pass before cracking initiates.
- e) Hard microstructures may arise in welds, particularly in low heat input welds in the heat affected zones, in low alloy steels, or may result from inadequate heat treatment.

#### 5.1.2.4.4 *Affected Units or Equipment*

- a) All piping and equipment exposed to HF acid at any concentration with hardness levels above the recommended limit are subject to hydrogen stress cracking.
- b) High strength low alloy steels such as ASTM A193-B7 bolts and compressor components are susceptible.
- c) ASTM A193B7M bolts are also susceptible if overtorqued.

#### 5.1.2.4.5 *Appearance or Morphology of Damage*

- a) This mode of cracking can only be confirmed by metallographic examination. The cracking will be intergranular.
- b) Produces surface breaking cracks, usually associated with weldments.

#### 5.1.2.4.6 *Prevention / Mitigation*

- a) PWHT is beneficial in reducing the hardness and residual stresses that render a steel susceptible to SSC.
- b) Typical low-strength carbon steels used in refinery applications should be controlled to produce weld hardness <200 HB in accordance with NACE SP0472. These steels are not generally susceptible to SCC unless localized zones of hardness above 237 HB are present.
- c) Use carbon steels with Carbon Equivalents (CE) less than 0.43. Where CE is defined as:

$$CE = \%C + \%Mn/6 + \%(\text{Cr} + \text{Mo} + \text{V})/5 + \%(\text{Cu} + \text{Ni})/15$$

- d) ASTM A193 grade B7M bolts are softer and lower strength than B7 bolts and are more resistant to cracking.
- e) Alloy cladding or nonmetallic coatings that provide an effective barrier and protect the surface of the steel from hydrogen permeation will prevent cracking.

- f) Alloy 400 is not susceptible to this form of cracking but may be susceptible to intergranular stress corrosion cracking, particularly in the non-stress relieved condition (see [5.1.1.6](#)).

#### **5.1.2.4.7      *Inspection and Monitoring***

- a) Surface breaking cracks can be found by WFMT.
- b) Hardness testing is the best method to determine the susceptibility of suspect material.
- c) Zones of high hardness can sometimes be found on the process side in weld cover passes and attachment welds that are not tempered (softened) by subsequent passes.

#### **5.1.2.4.8      *Related Mechanisms***

This is the same mechanism that is responsible for sulfide stress corrosion cracking in wet H<sub>2</sub>S environments except that HF acid is generating the hydrogen. Blistering, HIC and SOHIC damage is similar to that found in wet H<sub>2</sub>S (see [5.1.2.3](#)).

#### **5.1.2.4.9      *References***

1. J. D. Dobis, D. R. Clarida and J. P. Richert, "Survey Reveals Nature of Corrosion in HF Alkylation Units," Oil and Gas Journal, March 6, 1995, Vol. 93, No.10, pp. 63-68.
2. ASM Metals Handbook, "Corrosion in Petroleum Refining and Petrochemical Operations," Volume 13, ASM International, Materials Park, OH.
3. NACE SP0472, Methods and Controls to Prevent in-Service Environmental Cracking of Carbon Steel Weldments in Corrosive Petroleum Refining Environments, NACE International, Houston, TX.

### 5.1.2.5 Carbonate Stress Corrosion Cracking (ACSCC)

#### 5.1.2.5.1 *Description of Damage*

Carbonate stress corrosion cracking (often referred to as carbonate cracking) is the term applied to surface breaking cracks that occur adjacent to carbon steel welds under the combined action of tensile stress in systems containing a free water phase with carbonate, where some amount of H<sub>2</sub>S is also present. It is a form of Alkaline Stress Corrosion Cracking (ACSCC).

This type of damage has also been observed in other environments which are outside the scope of this discussion. Those environments include the outside surface of buried pipelines; and piping and equipment containing aqueous carbonate solutions (e.g., potassium carbonate) used in the carbon dioxide (CO<sub>2</sub>) removal facilities associated with hydrogen reformers.

#### 5.1.2.5.2 *Affected Materials*

Carbon steel and low alloy steels.

#### 5.1.2.5.3 *Critical Factors*

- a) The residual stress level of carbon steel and the water chemistry are the critical factors that determine the likelihood of carbonate cracking.
- b) Carbonate stress corrosion cracking can occur at relatively low levels of residual stress but usually occurs at welds or cold worked areas that have not been stress relieved.
- c) Additional details of water chemistry affecting susceptibility in FCC units are outlined below. More detailed information can be found in a NACE industry review published in 2008 (Reference 4).
  - 1) Water - In all areas in which ACSCC has been reported, there has been a separate liquid water phase present.
  - 2) pH - The pH of the sour water is a critical factor; most failures have occurred in the range of pH 8 to 10.
  - 3) H<sub>2</sub>S – Cracking occurs where alkaline water is present. Although H<sub>2</sub>S is often present, no threshold level has been established.
  - 4) Ammonia - NH<sub>3</sub> in the sour water is usually higher in cases where ACSCC has been observed than in cases with no ACSCC (e.g., 4,800 ppmw vs. 2,500 ppmw). Increasing NH<sub>3</sub> and decreasing H<sub>2</sub>S together increase the likelihood of ACSCC.
  - 5) Carbonate ion concentration – Cracking occurs above a certain threshold concentration. It has been suggested that levels above 100 ppmw can cause ACSCC, depending on the pH of the system. However, specific guidelines are difficult to define, largely as a result of the difficulty of sampling for carbonate ions and the lack of available data.
  - 6) Cyanides – Cracking can occur with or without the presence of cyanides.
  - 7) Polysulfides - There is no evidence to suggest that ammonium polysulfide injection increases or decreases the potential for ACSCC.
- d) FCCU feed quality and unit operation appear to have an effect on cracking susceptibility:
  - 1) Feed Nitrogen - The total nitrogen in FCCU feed is usually higher in cases where ACSCC has been observed than in cases with no ACSCC (e.g., 2,645 ppmw vs. 940 ppmw).
  - 2) Feed Sulfur – In general, cracking is associated with low sulfur FCCU feeds as opposed to high sulfur feeds. Susceptibility to cracking appears to be much more likely with hydrotreated feed.
  - 3) N to S ratio – Most cases of ACSCC have been associated with N/S ratio in the FCCU feed of 0 to 70

- 4) Full burn vs. partial burn – The likelihood of cracking occurring in the FCC Regenerator partial-burn mode is approximately the same as full burn mode.
- e) In CO<sub>2</sub> removal units, cracking may occur when the CO<sub>2</sub> content is above 2% and temperatures exceed 200°F (93°C).

#### **5.1.2.5.4 Affected Units or Equipment**

- a) Carbonate cracking has been most prevalent in the fluid catalytic cracking unit main fractionator overhead condensing and reflux system, the downstream wet gas compression system, and the sour water systems emanating from these areas. Both piping and vessels are affected. See [Figure 5-44](#) and [5-45](#) for typical locations where cracking has occurred.
- b) Carbonate cracking has also been observed in SWS units of the side-pumparound type in the pumparound return line to the SWS tower; on the OD (process side) of highly cold worked SA179 condenser tube u-bends; and in the floor of tank storing sour water from an FCC unit.
- c) Carbonate cracking has also occurred in piping and equipment in potassium carbonate in Catacarb and CO<sub>2</sub> removal facilities of hydrogen manufacturing units.

#### **5.1.2.5.5 Appearance or Morphology of Damage**

- a) Carbonate cracking typically propagates parallel to the weld in the heat-affected zone, or adjacent base metal within 2 inches (50 mm) of the weld. At least two cases have been reported to occur more than 3 inches away (80 mm) in highly cold worked fittings including an elbow and reducer.
- b) Cracking can also occur in the weld deposit.
- c) The pattern of cracking observed on the steel surface is sometimes described as a spider web of small cracks, which often initiate at or interconnect with weld-related flaws that serve as local stress raisers.
- d) These cracks may be easily mistaken for SSC or SOHIC, however, the carbonate cracks are usually further from the toe of the weld and have multiple parallel cracks ([Figure 5-46](#) to [Figure 5-47](#)).
- e) Carbonate cracks are surface breaking flaws that are predominantly intergranular in nature and typically occur in as-welded carbon steel fabrications as a network of very fine, oxide-filled cracks similar in appearance to caustic stress corrosion cracking and amine stress corrosion cracking. See [Figures 5-48](#) to [Figure 5-55](#).

#### **5.1.2.5.6 Prevention / Mitigation**

- a) Application of a post-fabrication stress-relieving heat treatment of 1200°F to 1225°F (649°C to 663°C) in accordance with WRC 452 (Reference 8) is a proven method of preventing carbonate cracking. Heat treatment requirements apply to repair welds as well as internal and external attachment welds.
- b) Cracking can be eliminated through the use of effective barrier coatings, solid or clad 300 Series SS, Alloy 400 or other corrosion resistant alloys in lieu of carbon steel.
- c) Water wash non-PWHT piping and equipment prior to steamout or heat treatment in hot carbonate systems.
- d) A metavanadate inhibitor can be used in hot carbonate systems in CO<sub>2</sub> removal units in hydrogen manufacturing units to prevent cracking. Proper dosing and oxidation of the inhibitor must be maintained.

#### **5.1.2.5.7 Inspection and Monitoring**

- a) Monitoring the pH of FCC sour waters is the fastest and most practical and cost effective method to locate areas where there is a potential for ASCC to occur.

- b) The cracking can involve sporadic and rapid growth, depending on subtle changes in the process. Periodic monitoring of  $\text{CO}_3^{2-}$  concentration in FCC sour waters should be done to determine cracking susceptibility.
- c) Although cracks may be seen visually, crack detection is best performed with WFMT or ACFM techniques. Surface preparation by grit blasting, high pressure water blasting or other methods is usually required for WFMT. PT usually cannot find tight or scale filled cracks and should not be used.
- d) There is usually much branching so crack depths may be measured with a suitable UT technique including external SWUT. Electrical resistance type instruments that measure crack depth are not effective because the cracks typically contain magnetic iron oxide.
- e) This cracking is not susceptible to extension by grinding. Grinding out the cracks is a viable method of crack depth determination.
- f) AET can be used for monitoring crack growth and locating growing cracks.

#### **5.1.2.5.8      *Related Mechanisms***

Carbonate cracking is more properly termed carbonate stress corrosion cracking and is a form of Alkaline Stress Corrosion Cracking (ASCC). Amine cracking (see 5.1.2.2) and caustic stress corrosion cracking (see 4.5.3) are two other similar forms of ASCC.

#### **5.1.2.5.9      *References***

1. J.H. Kmetz and D.J. Truax, "Carbonate Stress Corrosion Cracking of Carbon Steel in Refinery FCC Main Fractionator Overhead Systems," CORROSION/90, Paper No. 206, NACE International, Houston, TX, 1990.
2. H.U. Schutt, "Intergranular Wet Hydrogen Sulfide Cracking," CORROSION/92, Paper No. 454, NACE International, Houston, TX, 1992.
3. E. Mirabel et al, "Carbonate-type Cracking in an FCC Wet Gas Compressor Station," Materials Performance, July, 1991, pp. 41-45.
4. NACE Standard RP0296, "Guidelines for Detection, Repair and Mitigation of Cracking of Existing Petroleum Refinery Pressure Vessels in Wet H<sub>2</sub>S Environments, NACE International, Houston, TX.
5. NACE Publication 34108, Review and Survey of Alkaline Carbonate Stress Corrosion Cracking in Refinery Sour Water, NACE International, Houston, TX, 2008.
6. M. Rivera et al., "Carbonate Cracking Risk Assessment for an FCCU Gas Plant", Paper #04639, NACE International, Houston, TX, 2004.
7. D. Milton et al., , FCCU Light Ends Plant Carbonate Stress Corrosion Cracking Experience, Paper #07564, NACE International, Houston, TX, 2007.
8. WRC Bulletin 452, "Recommended Practices for Local Heating of Welds in Pressure Vessels"
9. Welding Research Council (WRC), Shaker Heights, OH.

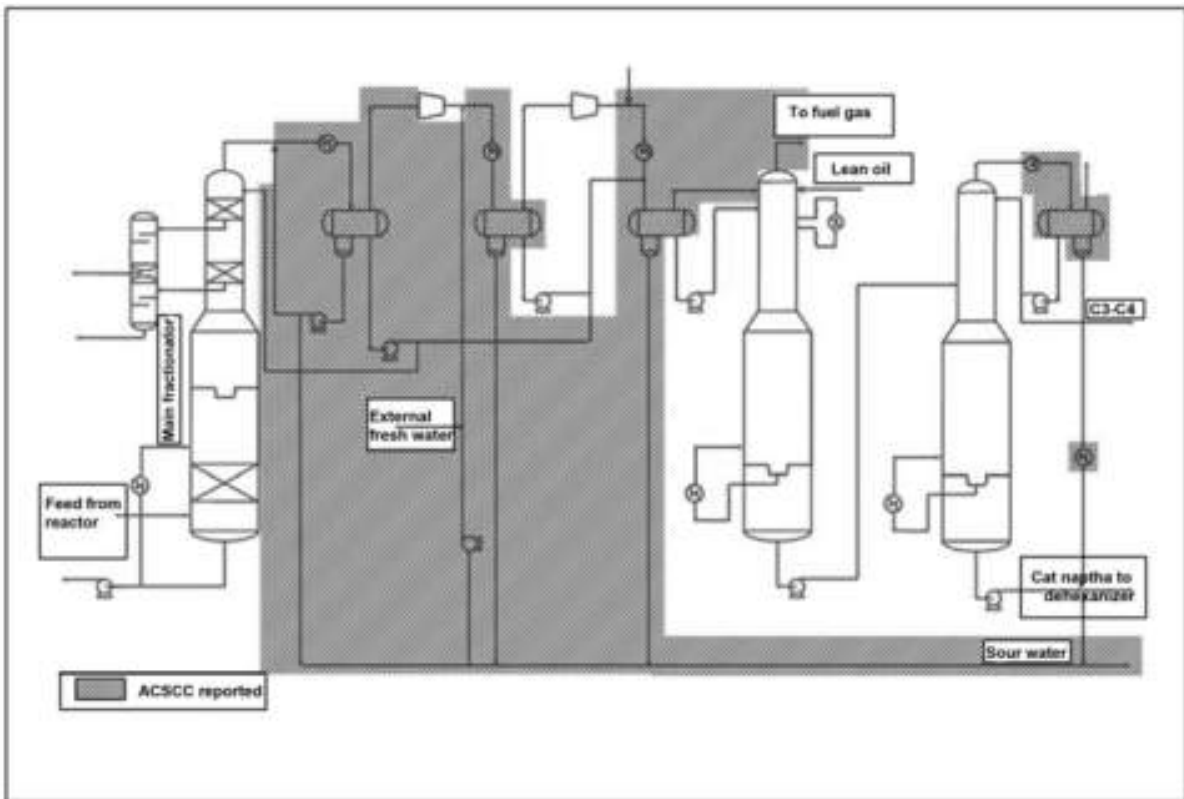
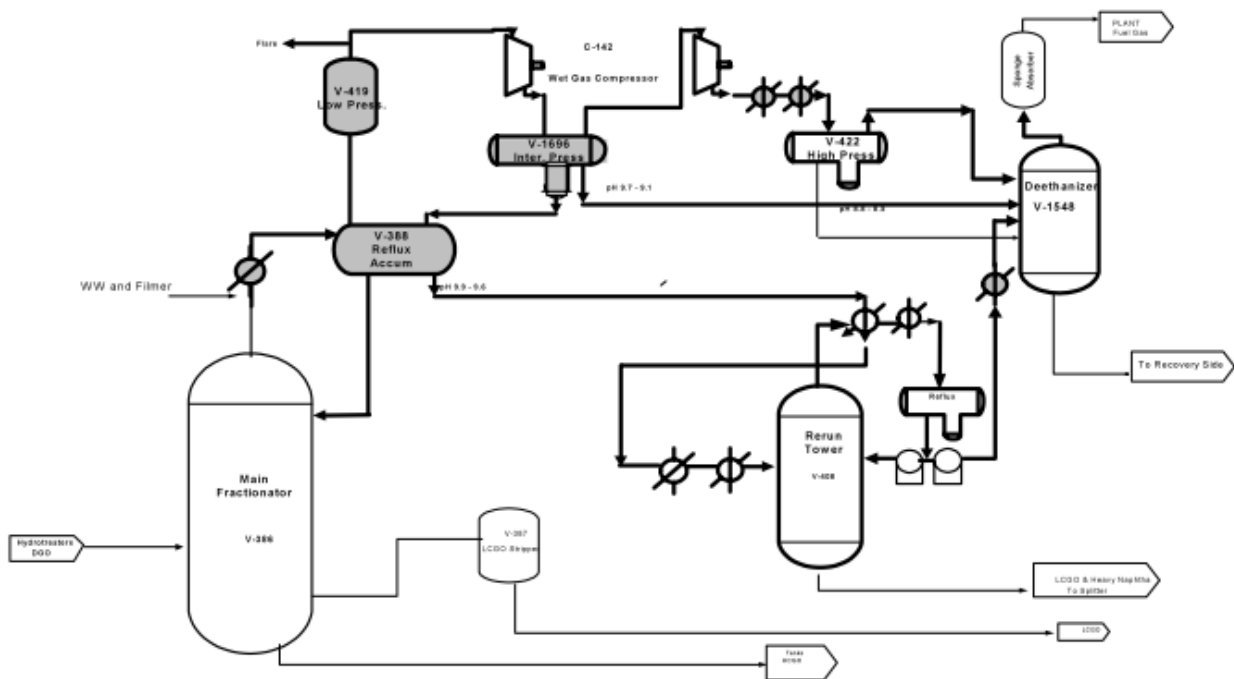


Figure 5-44 – Simplified PFD of an FCCU gas plant showing where ACSCC has been reported (Reference 5).

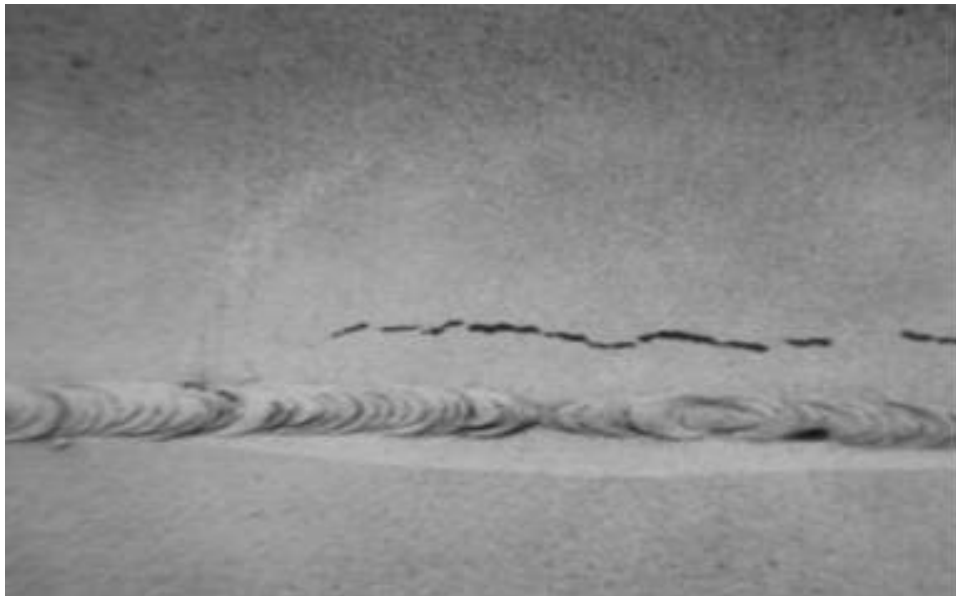


**Figure 5-45 – In a span of 7 months, a refinery experienced 23 leaks in piping in the Fractionator Overhead and the Wet Gas Compressor sections. Follow-up with SWUT located 73 more indications (Reference 6)**

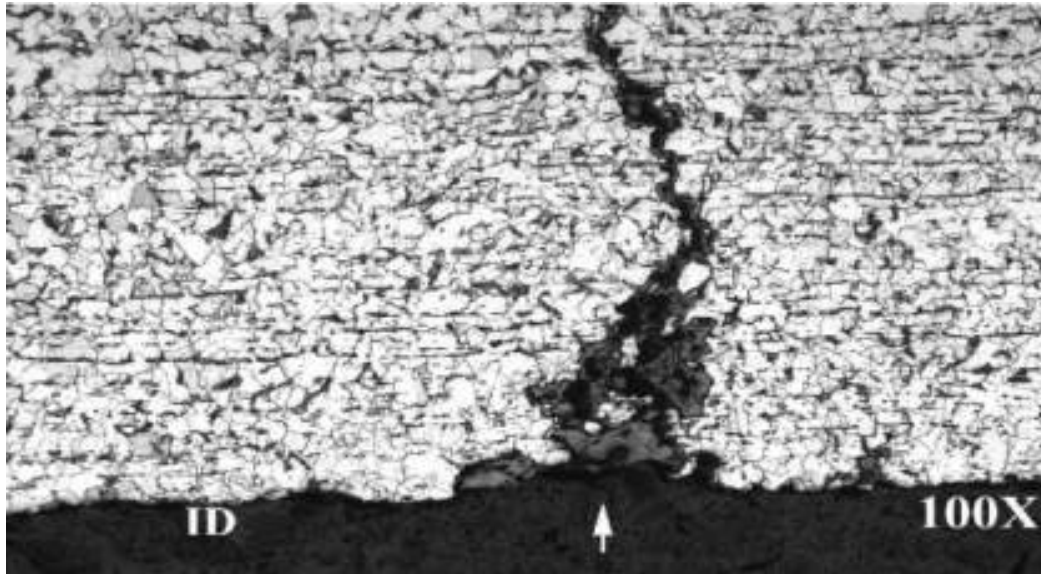




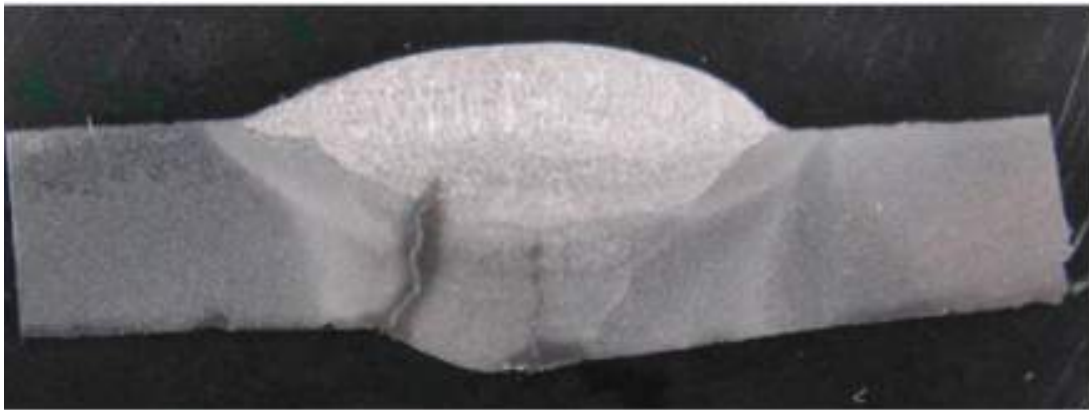
**Figure 5-46 – Overhead interstage knockout drum vapor outlet nozzle.**



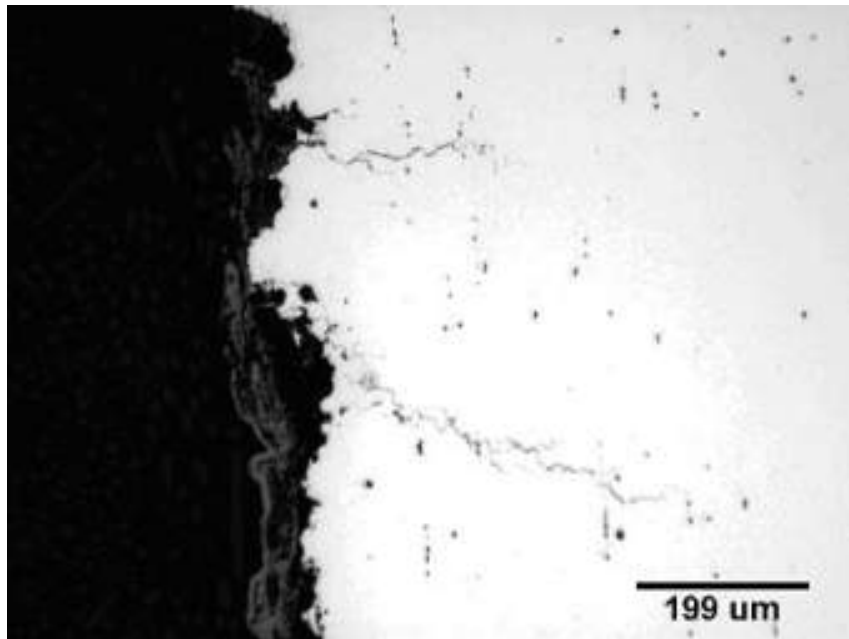
**Figure 5-47 – Carbonate cracking adjacent to a weld (Reference 6).**



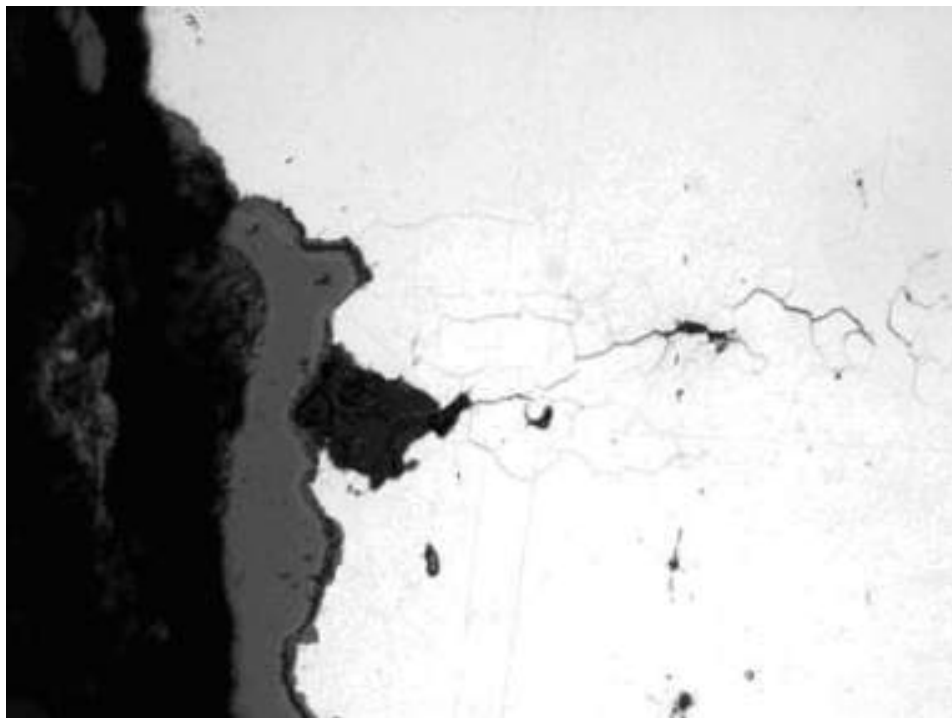
**Figure 5-48 – Metallographic sample showing intergranular carbonate cracking developed after 6 months service (Reference 6).**



**Figure 5-49 – Most cracks originate in base metal but this weldment contained a crack that originated at the root and propagated through the weld metal. Other cracks appear to have initiated in the HAZ (Reference 7).**



**Figure 5-50 – Photomicrograph of a cross-section of carbonate cracking in the base metal. Cracks initiate from the I.D. surface (left side). Unetched.**



**Figure 5-51 – Photomicrograph of a cross-section of carbonate cracking in the base metal, initiating at a corrosion pit on the ID surface. Unetched.**

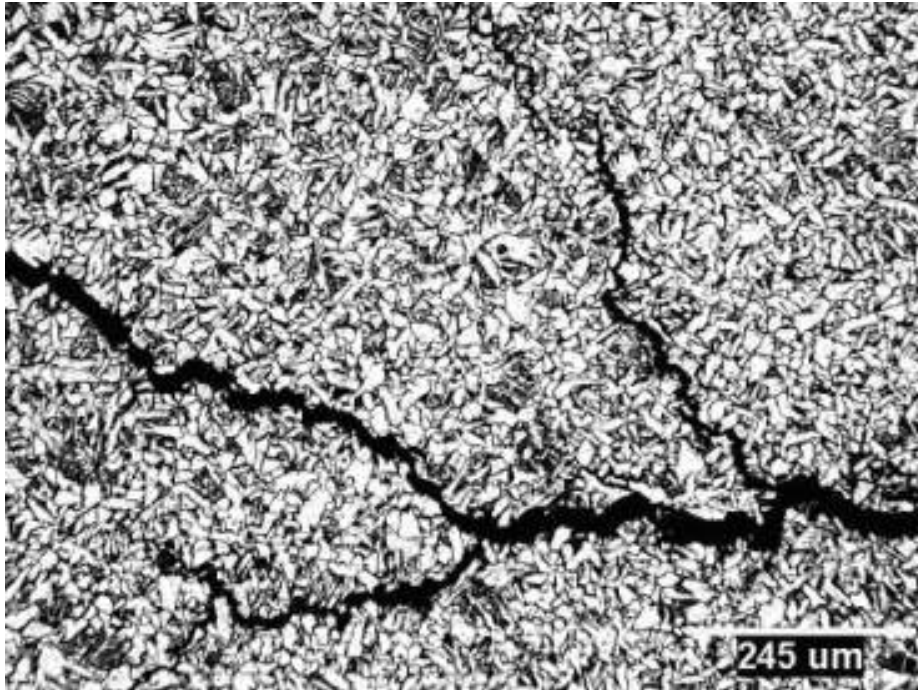


Figure 5-52 – Photomicrograph of a cross-section of carbonate cracking in the base metal, showing the branched nature of the cracking. Etched.

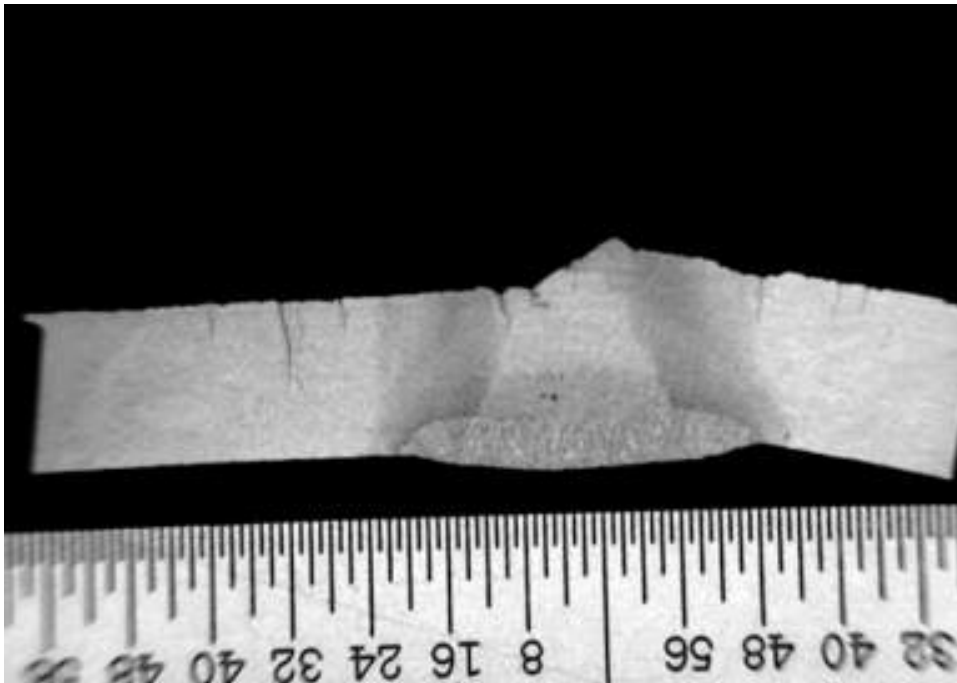
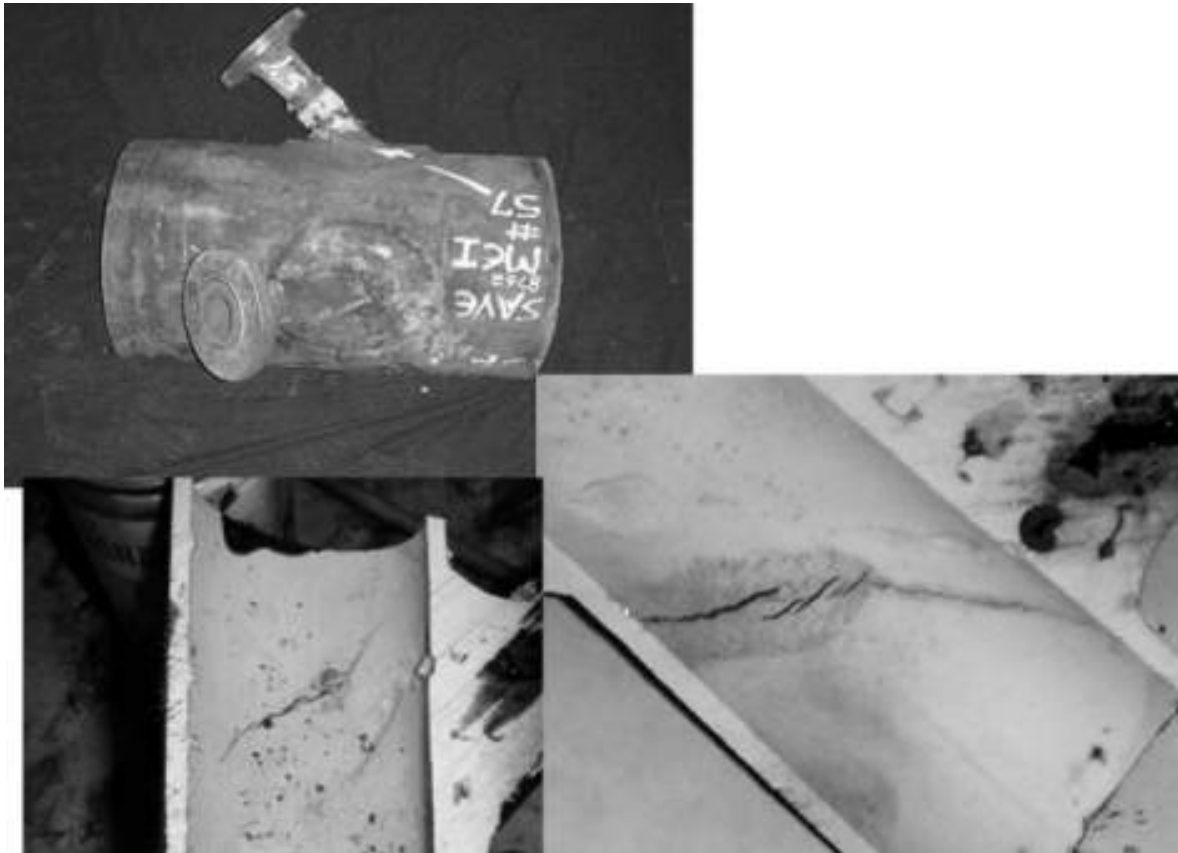
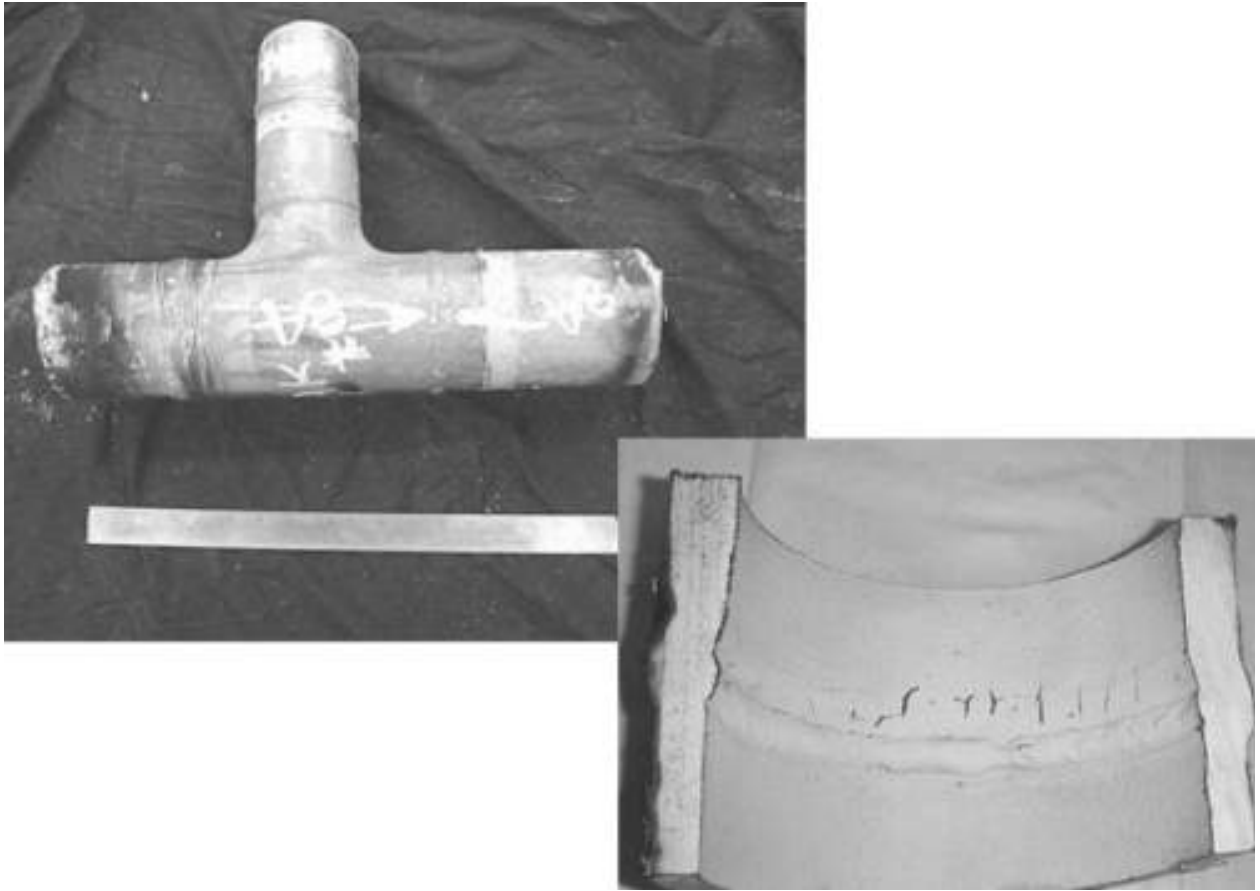


Figure 5-53 – Photomicrograph of a cross-section of a weld from a 4 inch (100 mm) ASTM A53 reflux line on the Main Fractionator that leaked after 52 years service.



**Figure 5-54 – An 18 inch (460 mm) diameter API 5L Grade B pipe section with two 1 in (25 mm) water wash injection nozzles at the inlet to the 2nd stage compressor. Note the cracks on the ID of the two injection nozzles after blast cleaning. The line leaked after 21 years service.**



**Figure 5-55 – A 3 in x 4 in (76 mm x 100 mm) diameter tee in a hydrocarbon line off a water knockout pot in the FCC light ends recovery section. Cracking developed after 6 months service.**

### 5.1.3 Other Mechanisms

#### 5.1.3.1 High Temperature Hydrogen Attack (HTHA)

##### 5.1.3.1.1 Description of Damage

- a) High temperature hydrogen attack results from exposure to hydrogen at elevated temperatures and pressures. The hydrogen reacts with carbides in steel to form methane (CH<sub>4</sub>) which cannot diffuse through the steel. The loss of carbide causes an overall loss in strength.
- b) Methane pressure builds up, forming bubbles or cavities, microfissures and fissures that may combine to form cracks.
- c) Failure can occur when the cracks reduce the load carrying ability of the pressure containing part.

##### 5.1.3.1.2 Affected Materials

In order of increasing resistance: carbon steel, C-0.5Mo, Mn-0.5Mo, 1Cr-0.5Mo, 1.25Cr-0.5Mo, 2.25Cr-1Mo, 2.25Cr-1Mo-V, 3Cr-1Mo, 5Cr-0.5Mo and similar steels with variations in chemistry.

##### 5.1.3.1.3 Critical Factors

- a) For a specific material, HTHA is dependent on temperature, hydrogen partial pressure, time and stress. Service exposure time is cumulative.
- b) HTHA is preceded by a period of time when no noticeable change in properties is detectable by normal inspection techniques.
- c) The incubation period is the time period during which enough damage has occurred to be measured with available inspection techniques and may vary from hours at very severe conditions to many years.
- d) [Figure 5-56](#) contains curves that show a temperature/hydrogen partial pressure safe operating envelope for carbon and low alloy steels. Additional information on HTHA can be found in API RP 941.
- e) The curves are reasonably conservative for carbon steel up to about 10,000 psi hydrogen partial pressure.
- f) 300 Series SS, as well as 5Cr, 9Cr and 12 Cr alloys, are not susceptible to HTHA at conditions normally seen in refinery units.

##### 5.1.3.1.4 Affected Units

- a) Hydroprocessing units, such as hydrotreaters (desulfurizers) and hydrocrackers, catalytic reformers, hydrogen producing units and hydrogen cleanup units, such as pressure swing absorption units, are all susceptible to HTHA.
- b) Boiler tubes in very high pressure steam service.

##### 5.1.3.1.5 Appearance or Morphology of Damage

- a) HTHA can be confirmed through the use of specialized techniques including metallographic analysis of damaged areas as described below.
- b) The hydrogen/carbon reaction can cause surface decarburization of steel. If the diffusion of carbon to the surface is limiting, the reaction can result in internal decarburization, methane formation and cracking ([Figures 5-57 to 5-59](#)).
- c) In the early stages of HTHA, bubbles/cavities can be detected in samples by a scanning microscope, although it may be difficult to tell the difference between HTHA cavities and creep cavities. Some refinery services expose low alloy steels to both HTHA and creep conditions. Early stages of HTHA can only be confirmed through advanced metallographic analysis of damaged areas.

- d) In later stages of damage, decarburization and/or fissures can be seen by examining samples under a microscope and may sometimes be seen by in-situ metallography (Figure 5-60 and 5-61).
- e) Cracking and fissuring are intergranular and occur adjacent to pearlite (iron carbide) areas in carbon steels.
- f) Some blistering may be visible to the naked eye, due to either molecular hydrogen or methane accumulating in laminations in the steel.

#### **5.1.3.1.6 Prevention/Mitigation**

- a) Use alloy steels with chromium and molybdenum to increase carbide stability thereby minimizing methane formation. Other carbide stabilizing elements include tungsten and vanadium.
- b) Normal design practice is to use a 25°F to 50°F (14°C to 28°C) safety factor approach when using the API RP 941 curves.
- c) While the curves have served the industry well, there have been several failures of C-0.5Mo steels in refinery service under conditions that were previously considered safe. C-0.5Mo carbide stability under HTHA conditions may be due at least in part to the different carbides formed during the various heat treatments applied to the fabricated equipment.
- d) As a result of the problems with the 0.5 Mo alloy steels, its curve has been removed from the main set of curves and the material is not recommended for new construction in hot hydrogen services. For existing equipment, this concern has prompted an economic review of inspection cost versus replacement with a more suitable alloy. Inspection is very difficult because problems have occurred in weld heat affected zones as well as base metal away from welds.
- e) 300 Series SS overlay and/or roll bond clad material is used in hydrogen service where the base metal does not have adequate sulfidation resistance. Although it is recognized that properly metallurgically bonded austenitic overlay/clad will decrease the hydrogen partial pressure seen by the underlying metal, most refiners make sure the base metal has adequate resistance to HTHA under service conditions. In some cases, refiners take the decrease in partial pressure into account when evaluating the need for hydrogen outgassing while shutting down heavy wall equipment.

#### **5.1.3.1.7 Inspection and Monitoring**

- a) Damage may occur randomly in welds or weld heat affected zones as well as the base metal, making monitoring and detection of HTHA in susceptible materials extremely difficult.
- b) Ultrasonic techniques using a combination of velocity ratio and AUBT have been the most successful in finding fissuring and/or serious cracking. HTHA damage can only be found using these techniques if damage has progressed to the point where microvoids would be visible at a magnification of 1500X or lower, if a sample of the metal was removed for examination.
- c) HTHA can occur in the base metal at locations remote from welds. In clad vessels, in particular, HTHA damage can occur in base metal at locations where cladding has become disbonded. Bulging of the cladding away from the underlying base metal may be a tell tale sign that HTHA has occurred. Localized damage under cladding might be overlooked if inspection methods focus only on the weld seams and nozzles (Reference 4).
- d) In-situ metallography can only detect microfissuring, fissuring and decarburization near the surface. However, most equipment has decarburized surfaces due to the various heat treatments used during fabrication.
- e) Visual inspection for blisters on the inside surface may indicate methane formation and potential HTHA. However, HTHA may frequently occur without the formation of surface blisters.
- f) Other conventional forms of inspection, including WFMT and RT, are severely limited in their ability to detect anything except the advanced stages of damage where cracking has already developed.
- g) AET is not a proven method for the detection of damage.



**5.1.3.1.8      *Related Mechanisms***

A form of HTHA can occur in boiler tubes and is referred to by the fossil utility industry as hydrogen damage.

**5.1.3.1.9      *References***

1. API RP 941, Steels for Hydrogen Service at Elevated Temperatures and Pressures in Petroleum Refineries and Petrochemical Plants, American Petroleum Institute, Washington, D.C.
2. J. Vitovec, F.H., "The Growth Rate of Fissures During Hydrogen Attack of Steels," API Division of Refining, Vol. 44 {III} 1964, pp. 179-188.
3. Materials Property Council Report FS-26, "Fitness-for Service Evaluation Procedures for Operating Pressure Vessels, Tanks, and Piping in Refinery and Chemical Service," Draft 5, Materials Properties Council, NY, 1995.
4. S. Decker et al., "Safe Operation of a High Temperature Hydrogen Attack Affected DHT Reactor", Paper #09339, NACE International, Houston, TX, 2009.

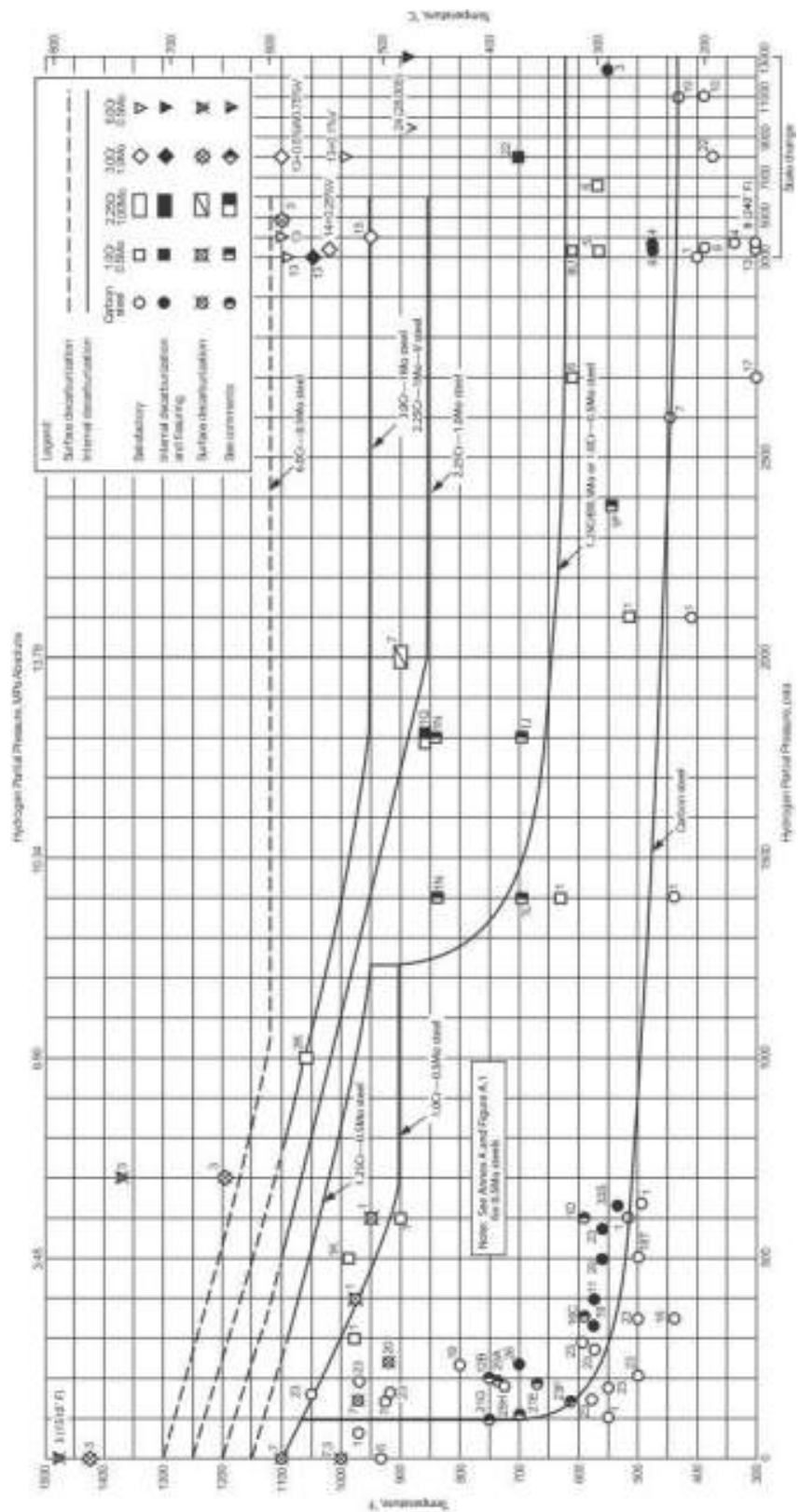


Figure 5-56 – Recommended pressure and H<sub>2</sub> partial pressure limits per API 941. (Reference 1)



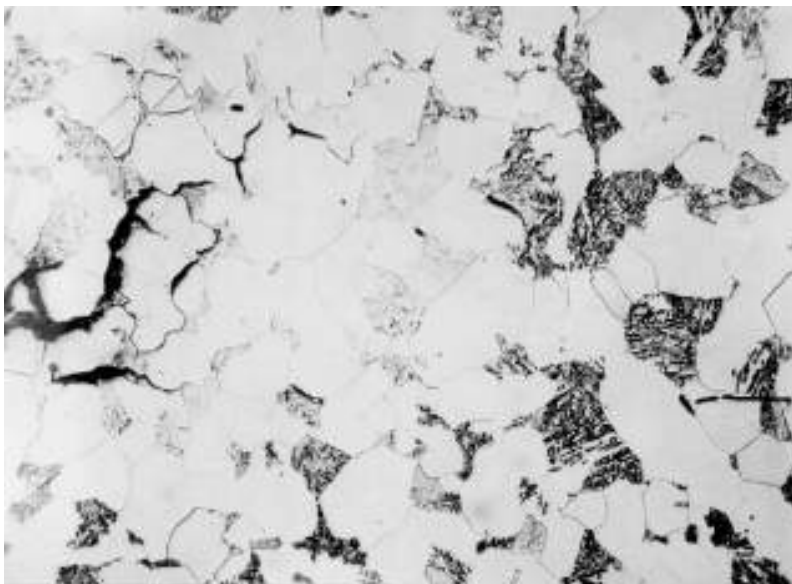
**Figure 5-57 – A pair of 10 inch Carbon-0.5Mo flanged pipe sections (SA335-P1 & SA234-WP1) from a hot bypass line in a catalytic reformer that was designed to remain closed but operated partially or fully open for unknown lengths of time. They were in service for ~34 years at temperatures up to 960°F (516°C) and a hydrogen partial pressure of 198 psig (1.37 MPa).**



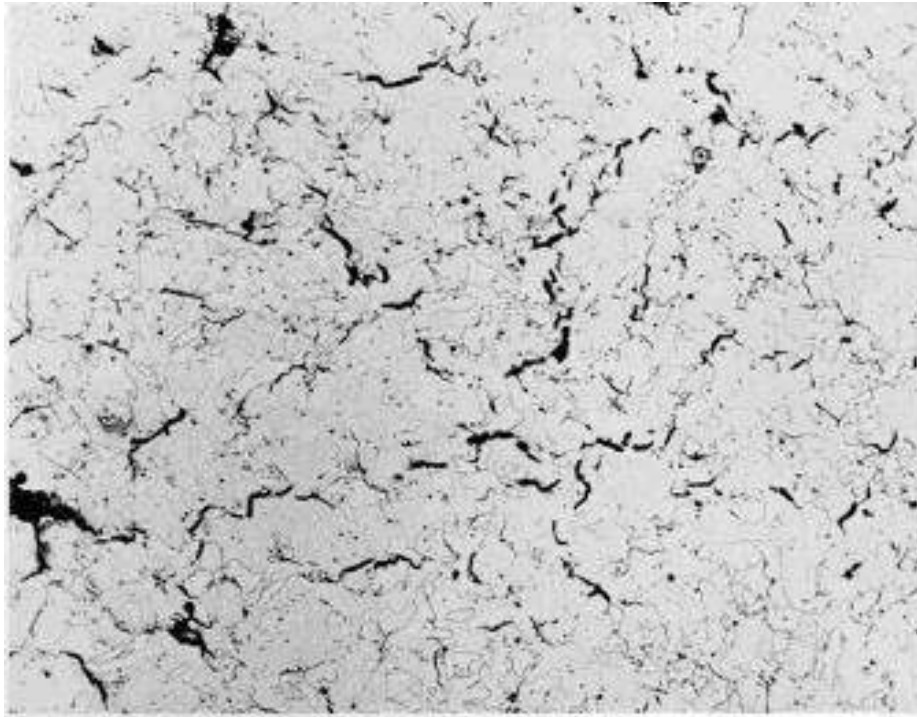
**Figure 5-58 – A photomicrograph of the outside surface of a pipe section, shown in the previous figure, exhibits a normal ferritic-pearlitic structure. Mag. 200X**



**Figure 5-59 – A photomicrograph at the pipe ID surface exhibiting of the pipe shown in the previous pictures, exhibiting complete decarburization of the original structure. Mag. 200X**



**Figure 5-60 – A photomicrograph illustrating decarburization and fissuring of C-0.5Mo steel.**



**Figure 5-61 – High magnification photomicrograph showing linkup of microfissures to form continuous cracks. Note that damage is accompanied by a significant amount of decarburization.**

### 5.1.3.2 Titanium Hydriding

#### 5.1.3.2.1 *Description of Damage*

Hydriding of titanium is a metallurgical phenomenon in which hydrogen diffuses into the titanium and reacts to form an embrittling hydride phase. This can result in a complete loss of ductility with no noticeable sign of corrosion or loss in thickness.

#### 5.1.3.2.2 *Affected Materials*

Titanium alloys.

#### 5.1.3.2.3 *Critical Factors*

- a) The critical factors are metal temperature, solution chemistry and alloy composition.
- b) This is a phenomenon that occurs in specific environments at temperatures above 165°F (74°C) and at a pH below 3, pH above 8 or neutral pH with high H<sub>2</sub>S content.
- c) Galvanic contact between titanium and more active materials such as carbon steel and 300 Series SS promotes damage. However, hydriding can occur in the absence of a galvanic coupling.
- d) Embrittlement occurs over a period of time as hydrogen is absorbed by the component and reacts to form embrittling hydride phases. The depth and extent of hydriding will continue to increase until a complete loss of ductility results.
- e) Hydriding has also occurred in some chemical environments as a result of the corrosion of iron which has been accidentally embedded into the surface of titanium during fabrication. Corrosion of iron and iron sulfide scale in the process streams brought in from upstream units can result in hydrogen pickup.
- f) The solubility of hydrogen in pure titanium and alpha-beta alloys is limited (50 - 300 ppm) and once this is exceeded, hydride is formed. Beta alloys, on the other hand, are more tolerant of hydrogen and 2000 ppm can be tolerated.

#### 5.1.3.2.4 *Affected Units or Equipment*

- a) Damage has occurred primarily in sour water strippers and amine units in the overhead condensers, heat exchanger tubes, piping and other titanium equipment operating above about 165°F (74°C).
- b) Hydriding can also occur in hydrogen atmospheres at temperatures >350°F (177°C), especially in the absence of moisture or oxygen.
- c) Cathodically protected equipment with protection potentials <-0.9 v SCE.

#### 5.1.3.2.5 *Appearance or Morphology of Damage*

- a) Titanium hydriding is a metallurgical change that is not readily apparent, and can only be confirmed through metallurgical techniques ([Figure 5-62](#), [Figure 5-63](#) and [Figure 5-64](#)) or mechanical testing.
- b) A quick test for embrittlement is a bend test or a crush test in a vice. Unaffected titanium will be crushed in a ductile fashion while embrittled components will crack and/or shatter with little or no sign of ductility.
- c) Heat exchanger tubes that have become embrittled may remain intact until disturbed by removal of the bundle for inspection. The tubes crack as the bundle flexes when it is removed.
- d) Cracking can occur if there is an attempt to re-roll tube ends that have become embrittled.
- e) Another possible damage mode that has occurred is ignition and fire of titanium tubes. Metallographic examination of titanium tubes from a bundle that burned showed significant amounts of hydride, especially in the vicinity of the metal that had been melted.

**5.1.3.2.6 Prevention / Mitigation**

- a) Titanium should not be used in known hydriding services such as amine or sour water, where the possibility of a leak is not acceptable.
- b) Where galvanic contact has promoted hydriding, the problem can be avoided by using all titanium construction or by electrically isolating the titanium from non-titanium components. Eliminating the galvanic couple may not prevent hydriding in alkaline sour water environments.

**5.1.3.2.7 Inspection and Monitoring**

- a) Specialized eddy current techniques are reported to have been able to detect hydriding damage.
- b) There are no other techniques to monitor or inspect for titanium hydriding other than the metallurgical and/or mechanical methods mentioned above.

**5.1.3.2.8 Related Mechanisms**

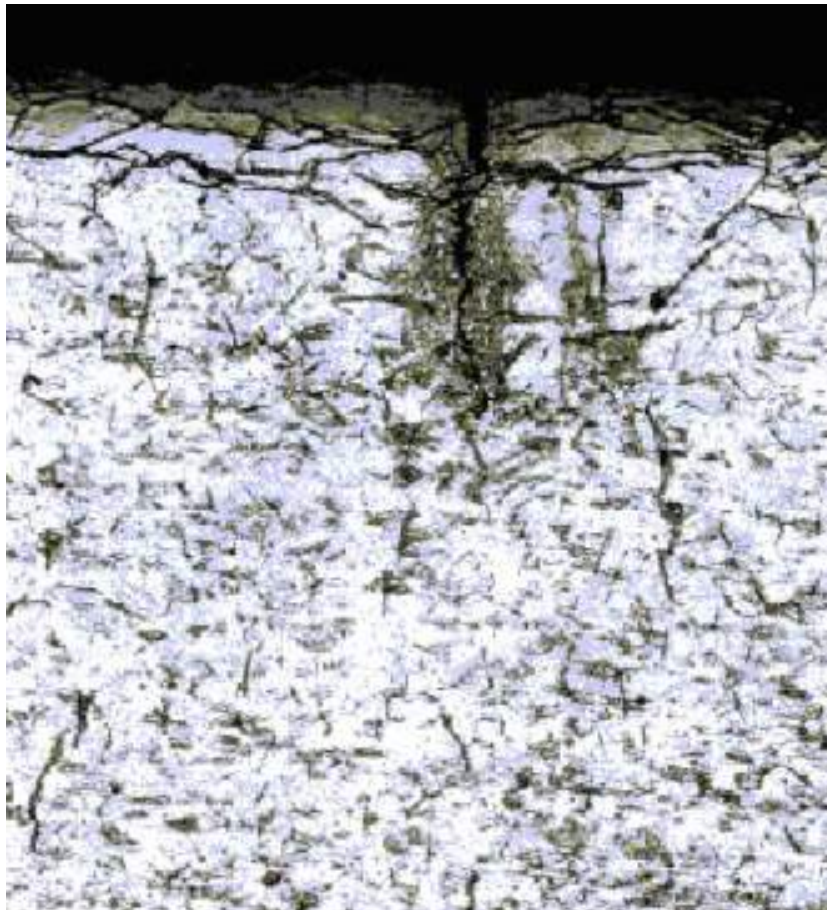
Hydriding is a damage mechanism that is unique to a few materials including alloys of titanium and zirconium.

**5.1.3.2.9 References**

1. B.E. Hopkinson and O. Fermin Hernandez, "Use of Titanium in Petroleum Refining," *Materials Performance*, September, 1990, pp.48-52.
2. J.B. Cotton, "Using Titanium in the Chemical Plant," *Chemical Engineering Progress*, Volume 66 , No. 10, 1977, p. 57.
3. L.C. Covington, "Factors Affecting the Hydrogen Embrittlement of Titanium," NACE Paper No.75, CORROSION/75, NACE International, Houston, TX, 1975.
4. L.C. Covington, "The Influence of Surface Condition and Environment on the Hydriding of Titanium," CORROSION, Volume 35, No. 8, 1979, pp. 378-382.
5. I. Phillips, P. Pool and L.L. Shreir, "Hydride Formation During Cathodic Polarization of Ti" and "Effect of Temperature and pH of Solution on Hydride Growth," *Corrosion Science*, Volume 14, 1974, pp. 533-542.
6. L.A. Charlot and R.H. Westerman, "Low Temperature Hydriding of Zircaloy-2 and Titanium in Aqueous Solutions," *Electrochemical Technology*, Volume 6, 1968.
7. R.W. Schutz, J.S. Grauman., and C. Covington, "Determination of Cathodic Protection Limits for Prevention of Titanium Tube Hydride Embrittlement in Salt Water," NACE Paper No. 110, CORROSION/89, NACE International, Houston, TX, 1989.
8. Z.F. Wang, C.L. Briant and K.S. Kumar, "Electrochemical, Galvanic and Mechanical Responses of Grade 2 Titanium in 6% Sodium Chloride Solution," CORROSION, Volume 55, No. 2, 1999, pp. 128-138.

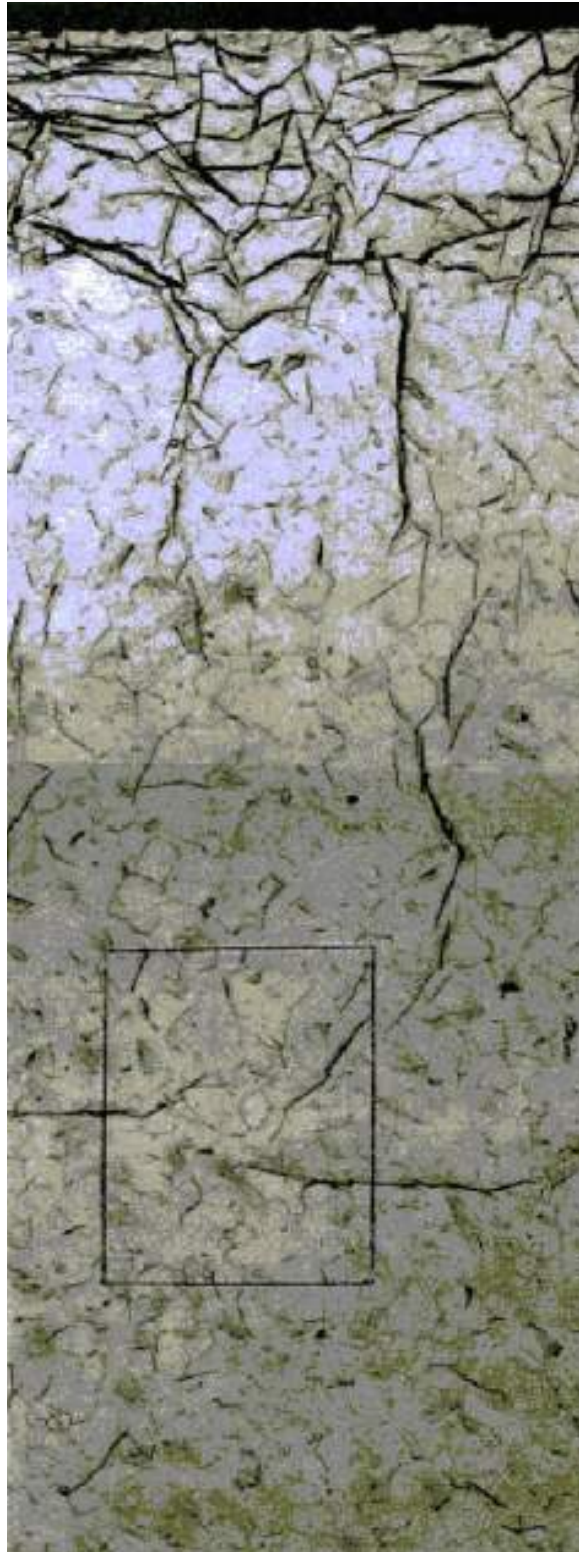


**Figure 5-62 – Titanium heat exchanger tube that failed from hydriding in a sour water cooler. The cooling medium is sea water.**



**Figure 5-63 – High magnification photomicrograph of a cross-section of the tube shown in Figure 5-62 through the crack tip. Mag. 200X.**





**Figure 5-64 – Another high magnification photomicrograph of a cross-section of the tube showing more of the cross section through the tip of the crack. Titanium hydrides are more clearly discernable. Mag. 400X.**

## 5.2 Process Unit PFD's

Simplified process flow diagrams for several process units commonly found in many refineries are shown in this section. The PFD's are highlighted to show some of the areas within the unit where many of the primary damage mechanisms can be found. The reader should be advised that this is not intended to be an all inclusive list of the damage mechanisms but should serve as a starting point for some of the major considerations.

The process flow diagrams included in this section are listed below. A key to the Damage Mechanisms used on the PFD's is shown in [Table 5-4](#).

- 5.2.1 **Crude Unit / Vacuum:** See [Figure 5-65](#).
- 5.2.2 **Delayed Coker:** See [Figure 5-66](#).
- 5.2.3 **Fluid Catalytic Cracking:** See [Figure 5-67](#).
- 5.2.4 **FCC Light Ends Recovery:** See [Figure 5-68](#).
- 5.2.5 **Catalytic Reforming – CCR:** See [Figure 5-69](#).
- 5.2.6 **Catalytic Reforming – Fixed Bed:** See [Figure 5-70](#).
- 5.2.7 **Hydroprocessing Units – Hydrotreating, Hydrocracking:** See [Figure 5-71](#).
- 5.2.8 **Sulfuric Acid Alkylation:** See [Figure 5-72](#).
- 5.2.9 **HF Alkylation:** See [Figure 5-73](#).
- 5.2.10 **Amine Treating:** See [Figure 5-74](#).
- 5.2.11 **Sulfur Recovery:** See [Figure 5-75](#).
- 5.2.12 **Sour Water Stripper:** See [Figure 5-76](#).
- 5.2.13 **Isomerization:** See [Figure 5-77](#).
- 5.2.14 **Hydrogen Reforming:** See [Figure 5-78](#).
- 5.2.15 **Visbreaker:** See [Figure 5-79](#).
- 5.2.16 **Caustic Treating:** See [Figure 5-80](#).

Table 5-4 – Key to Damage Mechanisms

DM#	Damage Mechanism	DM#	Damage Mechanism
1	Sulfidation	34	Softening (Spheroidization)
2	Wet H <sub>2</sub> S Damage (Blistering/HIC/SOHIC/SSC)	35	Reheat Cracking
3	Creep / Stress Rupture	36	Sulfuric Acid Corrosion
4	High temp H <sub>2</sub> /H <sub>2</sub> S Corrosion	37	Hydrofluoric Acid Corrosion
5	Polythionic Acid Cracking	38	Flue Gas Dew Point Corrosion
6	Naphthenic Acid Corrosion	39	Dissimilar Metal Weld (DMW) Cracking
7	Ammonium Bisulfide Corrosion	40	Hydrogen Stress Cracking in HF
8	Ammonium Chloride Corrosion	41	Dealloying (Dezincification/ Denickelification)
9	HCl Corrosion	42	CO <sub>2</sub> Corrosion
10	High Temperature Hydrogen Attack	43	Corrosion Fatigue
11	Oxidation	44	Fuel Ash Corrosion
12	Thermal Fatigue	45	Amine Corrosion
13	Sour Water Corrosion (acidic)	46	Corrosion Under Insulation (CUI)
14	Refractory Degradation	47	Atmospheric Corrosion
15	Graphitization	48	Ammonia Stress Corrosion Cracking
16	Temper Embrittlement	49	Cooling Water Corrosion
17	Decarburization	50	Boiler Water / Condensate Corrosion
18	Caustic Cracking	51	Microbiologically Induced Corrosion (MIC)
19	Caustic Corrosion	52	Liquid Metal Embrittlement
20	Erosion / Erosion-Corrosion	53	Galvanic Corrosion
21	Carbonate SCC	54	Mechanical Fatigue
22	Amine Cracking	55	Nitriding
23	Chloride Stress Corrosion Cracking	56	Vibration-Induced Fatigue
24	Carburization	57	Titanium Hydriding
25	Hydrogen Embrittlement	58	Soil Corrosion
26	Steam Blanketing	59	Metal Dusting
27	Thermal Shock	60	Strain Aging
28	Cavitation	61	Sulfate Stress Corrosion Cracking
29	Graphitic Corrosion (see Dealloying)	62	Phosphoric Acid Corrosion
30	Short term Overheating – Stress Rupture	63	Phenol (carbolic acid) Corrosion
31	Brittle Fracture	64	Ethanol Stress Corrosion Cracking
32	Sigma Phase/ Chi Embrittlement	65	Oxygen-Enhanced Ignition and Combustion
33	885°F (475°C) Embrittlement	66	Organic Acid Corrosion Of Distillation Tower Overhead Systems

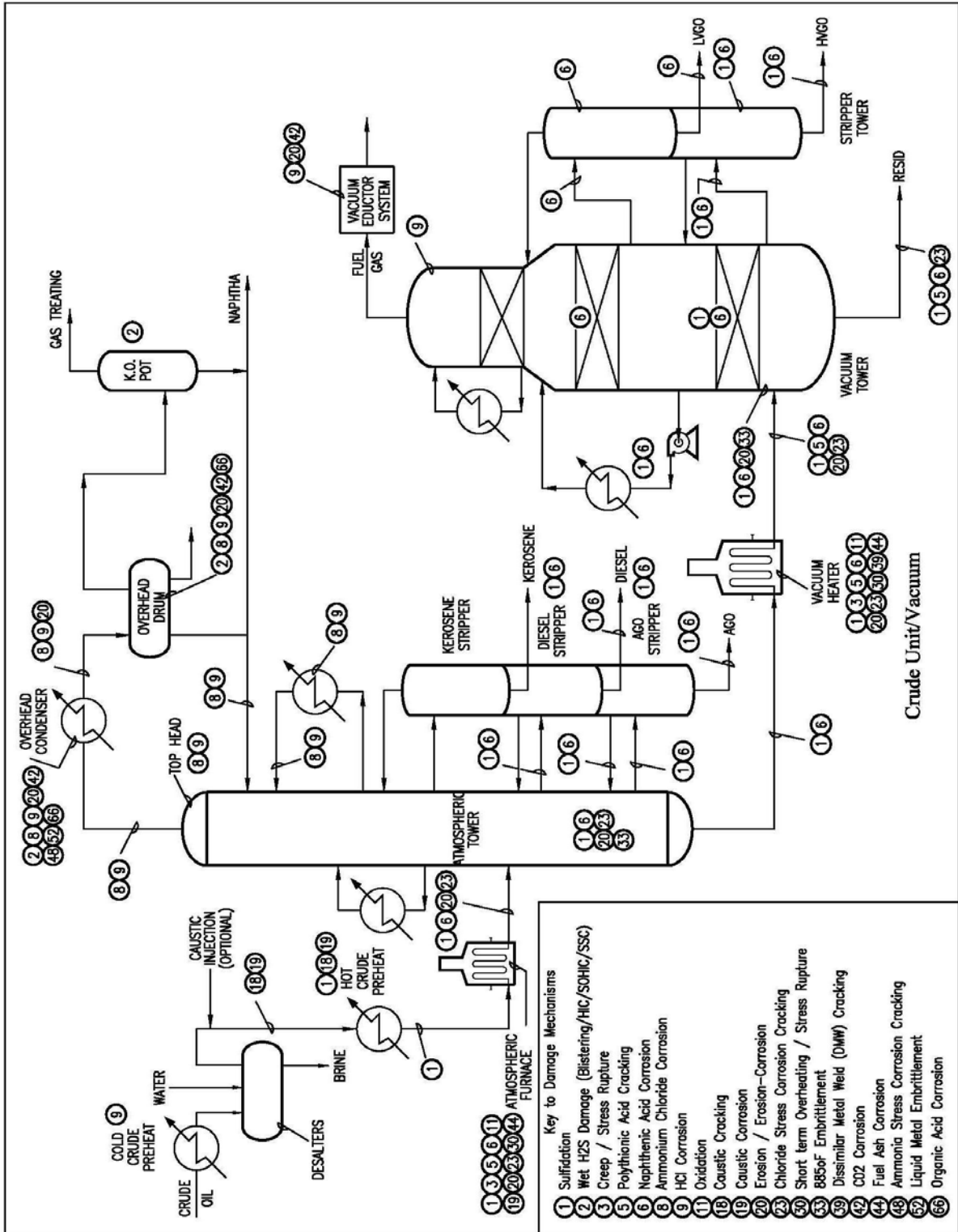


Figure 5-65 – Crude Unit / Vacuum

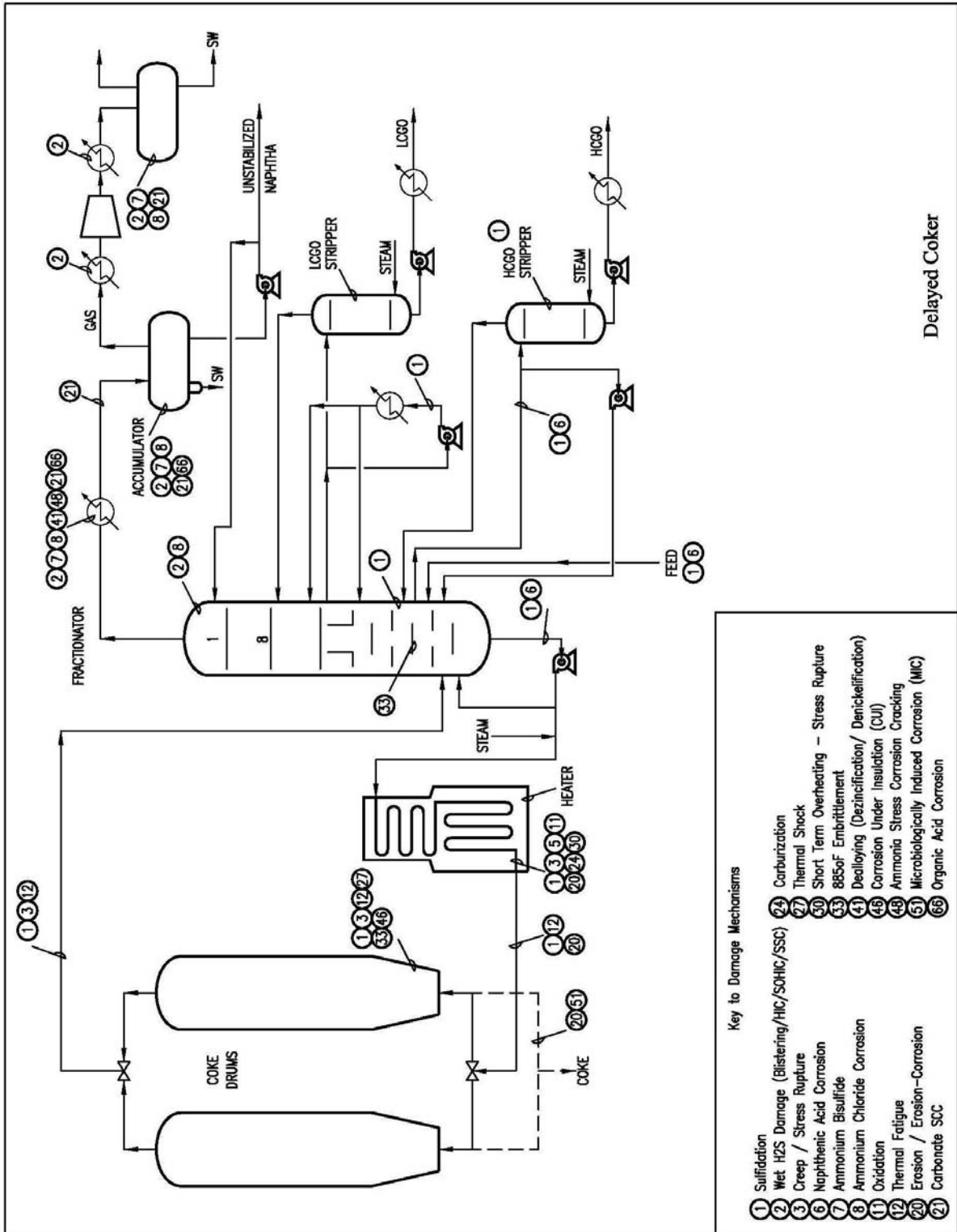


Figure 5-66 – Delayed Coker

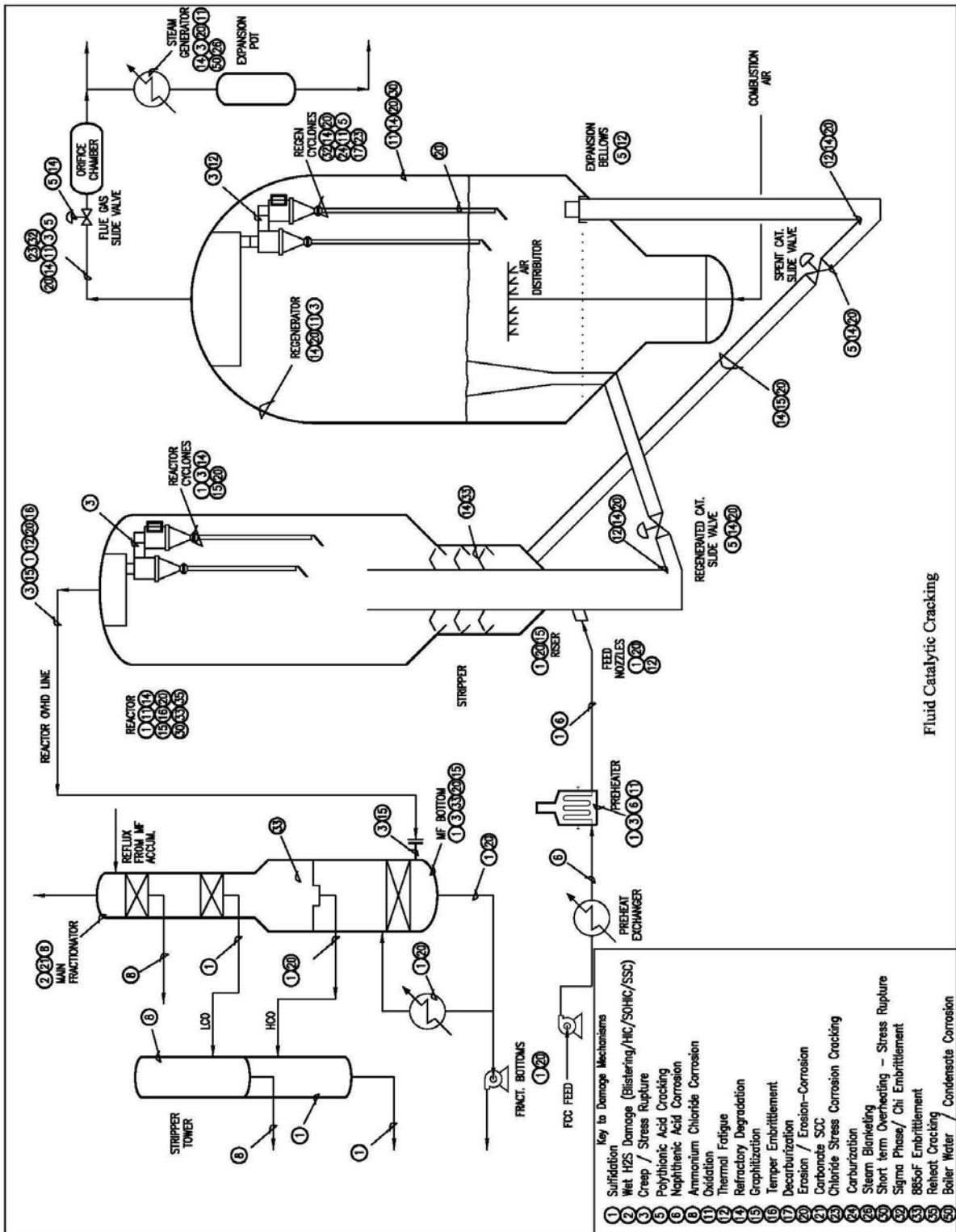


Figure 5-67 – Fluid Catalytic Cracking

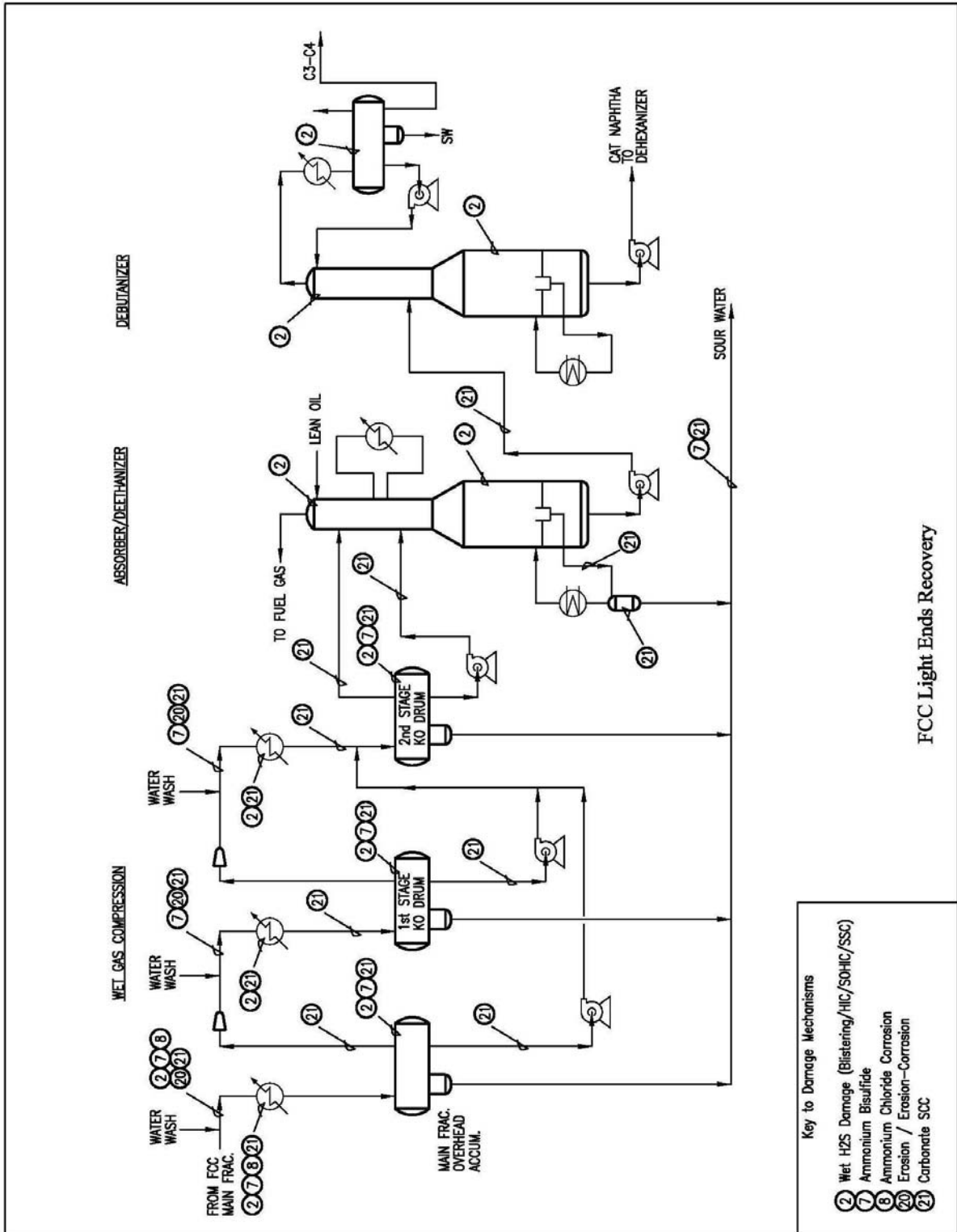


Figure 5-68 – FCC Light Ends Recovery

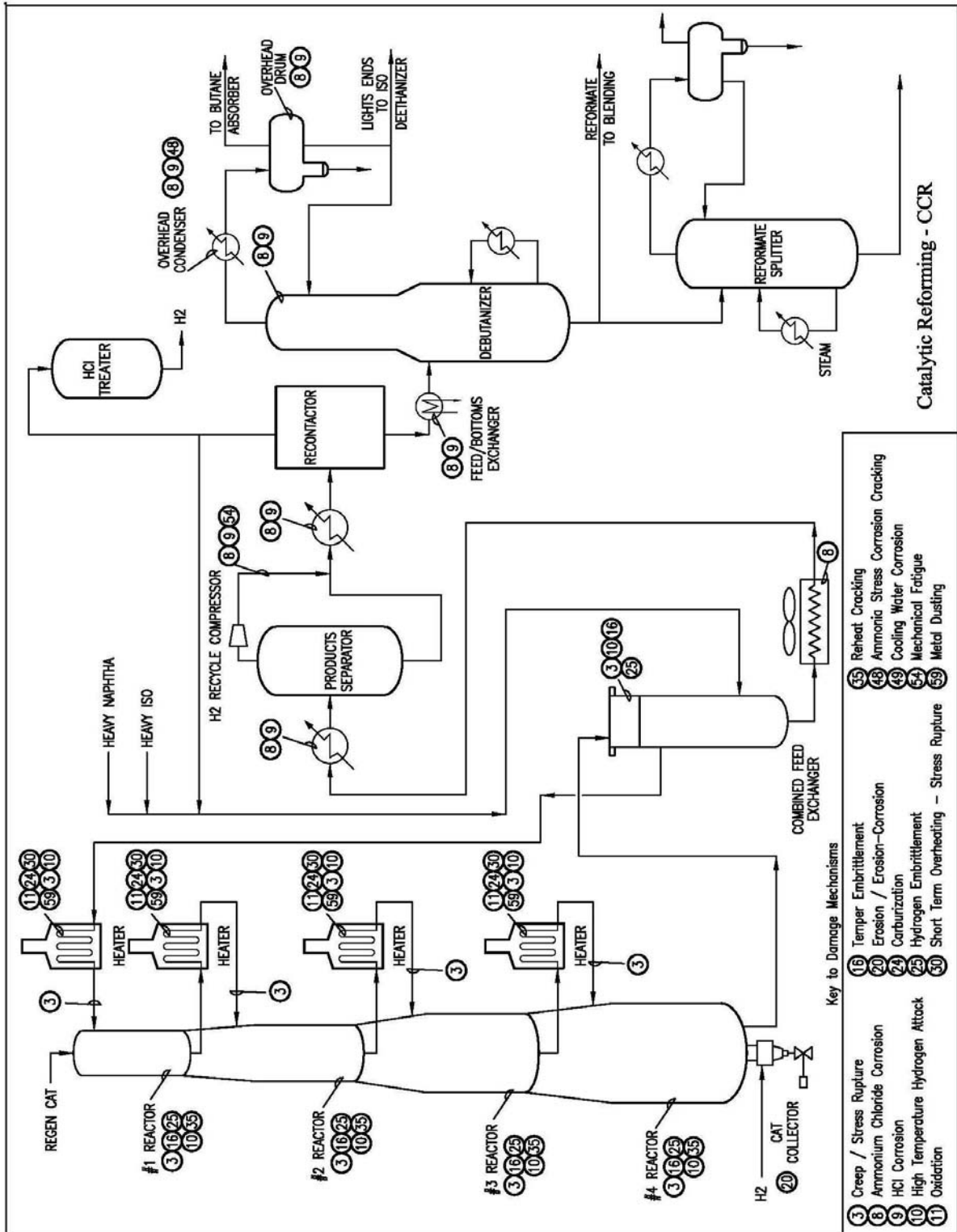


Figure 5-69 – Catalytic Reforming – CCR



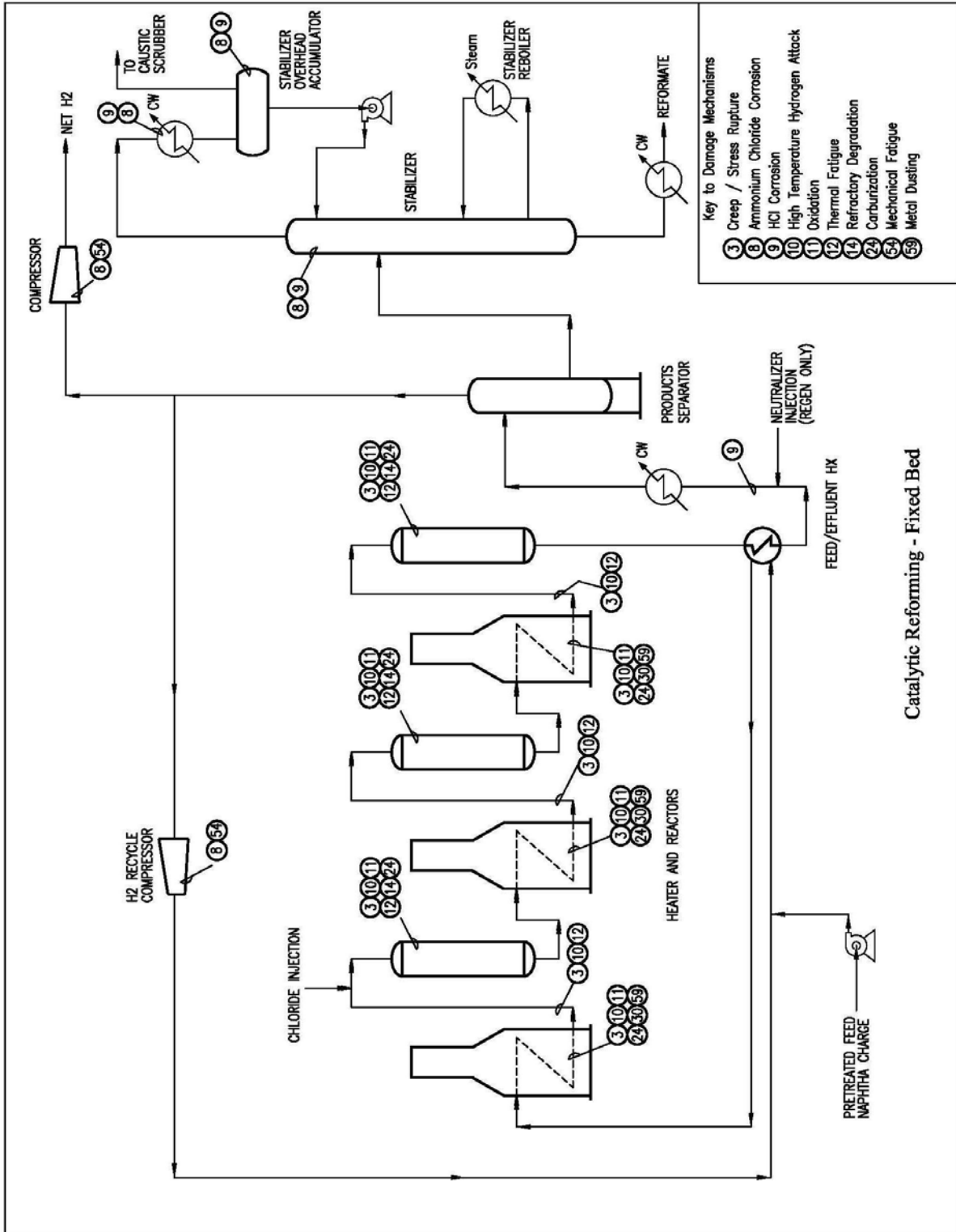


Figure 5-70 – Catalytic Reforming – Fixed Bed

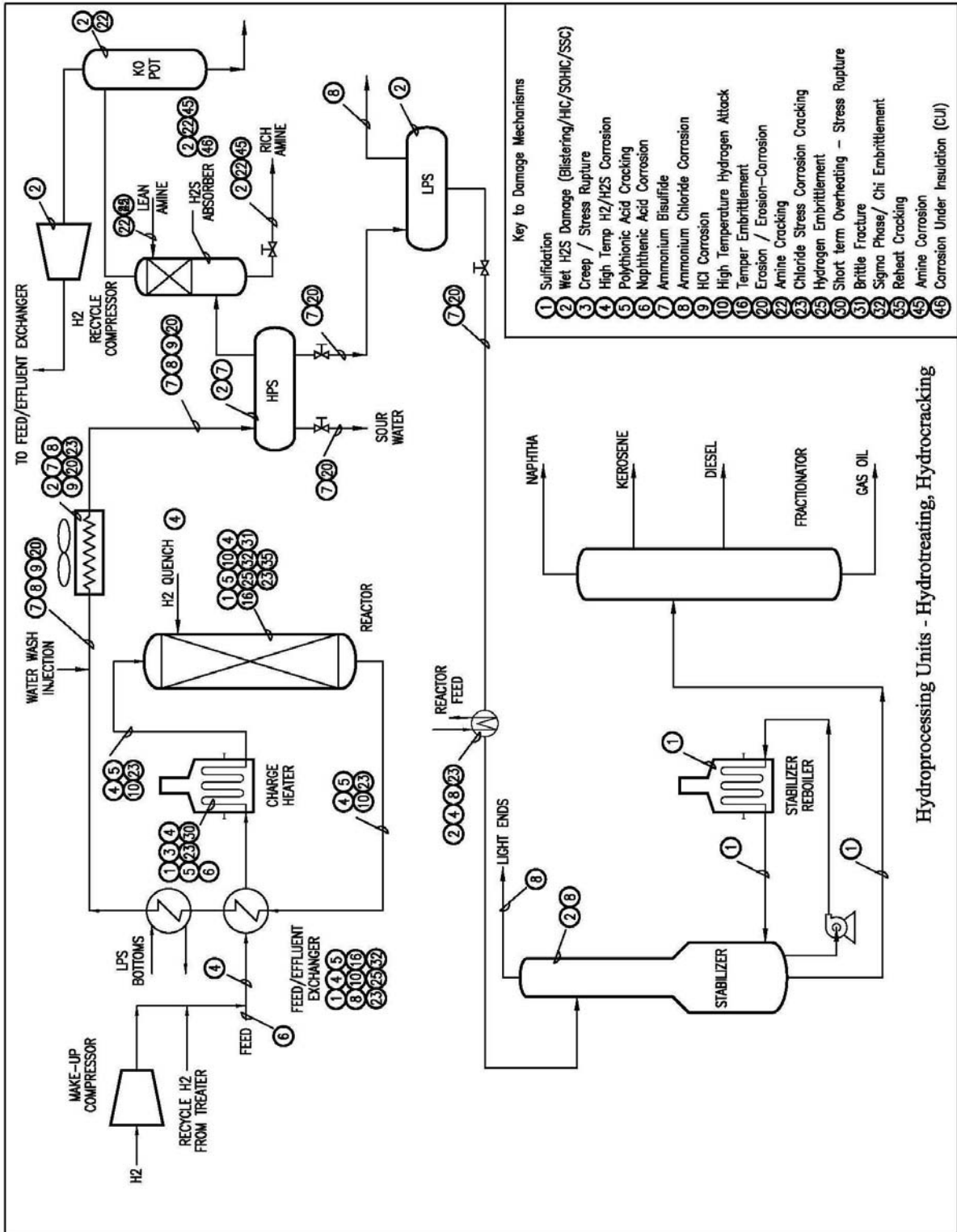


Figure 5-71 – Hydroprocessing - Hydrotreating, Hydrocracking

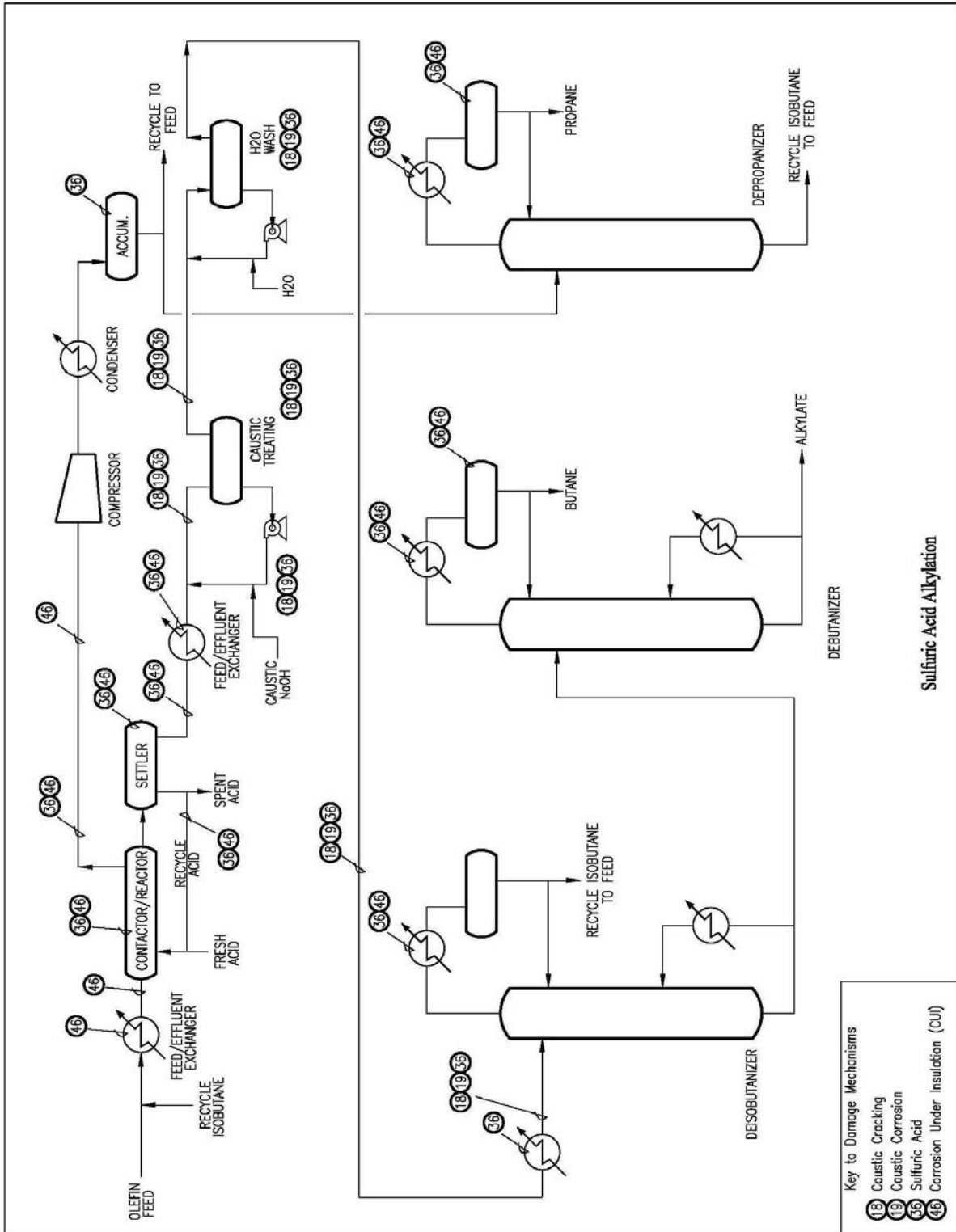
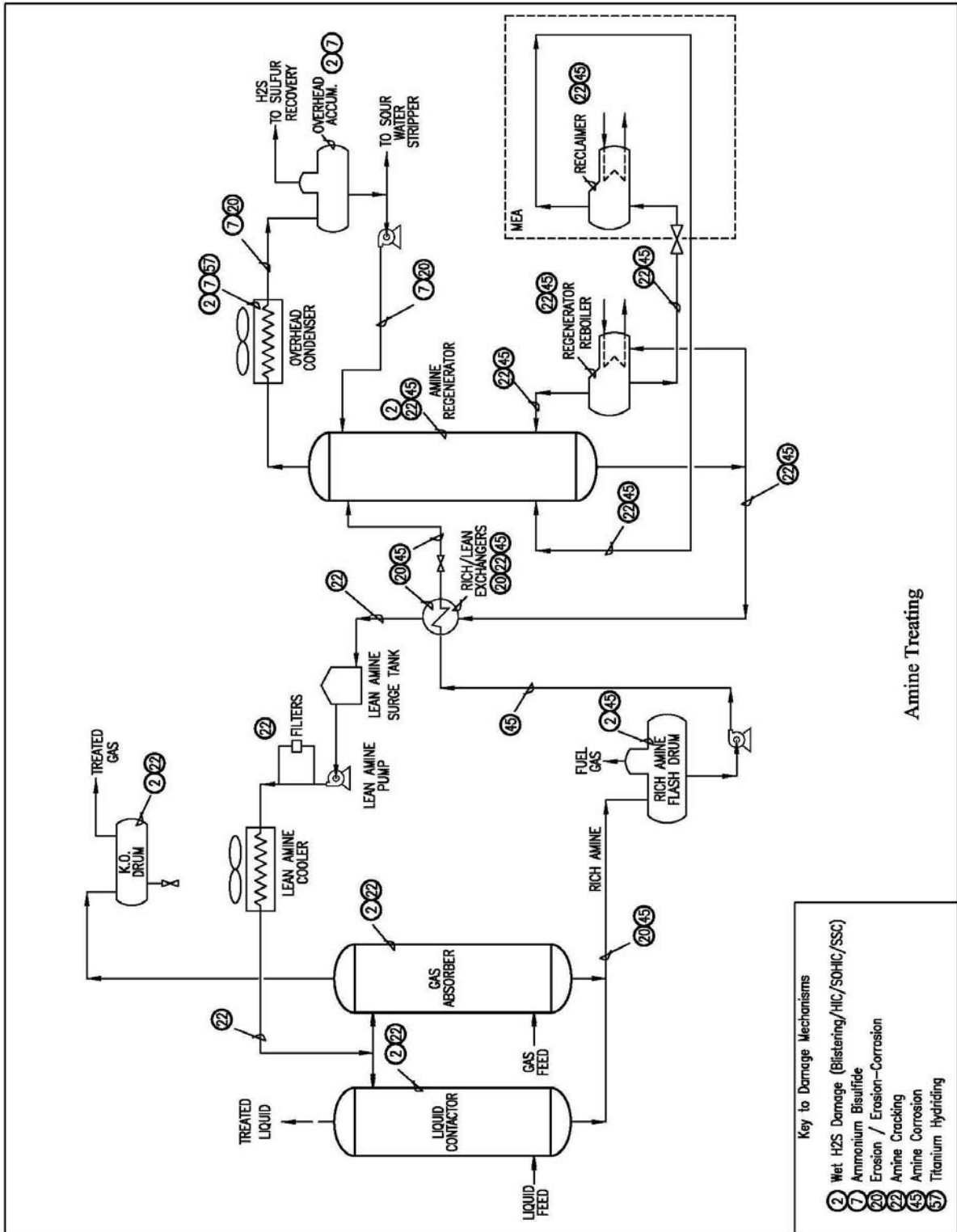


Figure 5-72 - Sulfuric Acid Alkylation





Amine Treating

Figure 5-74 – Amine Treating

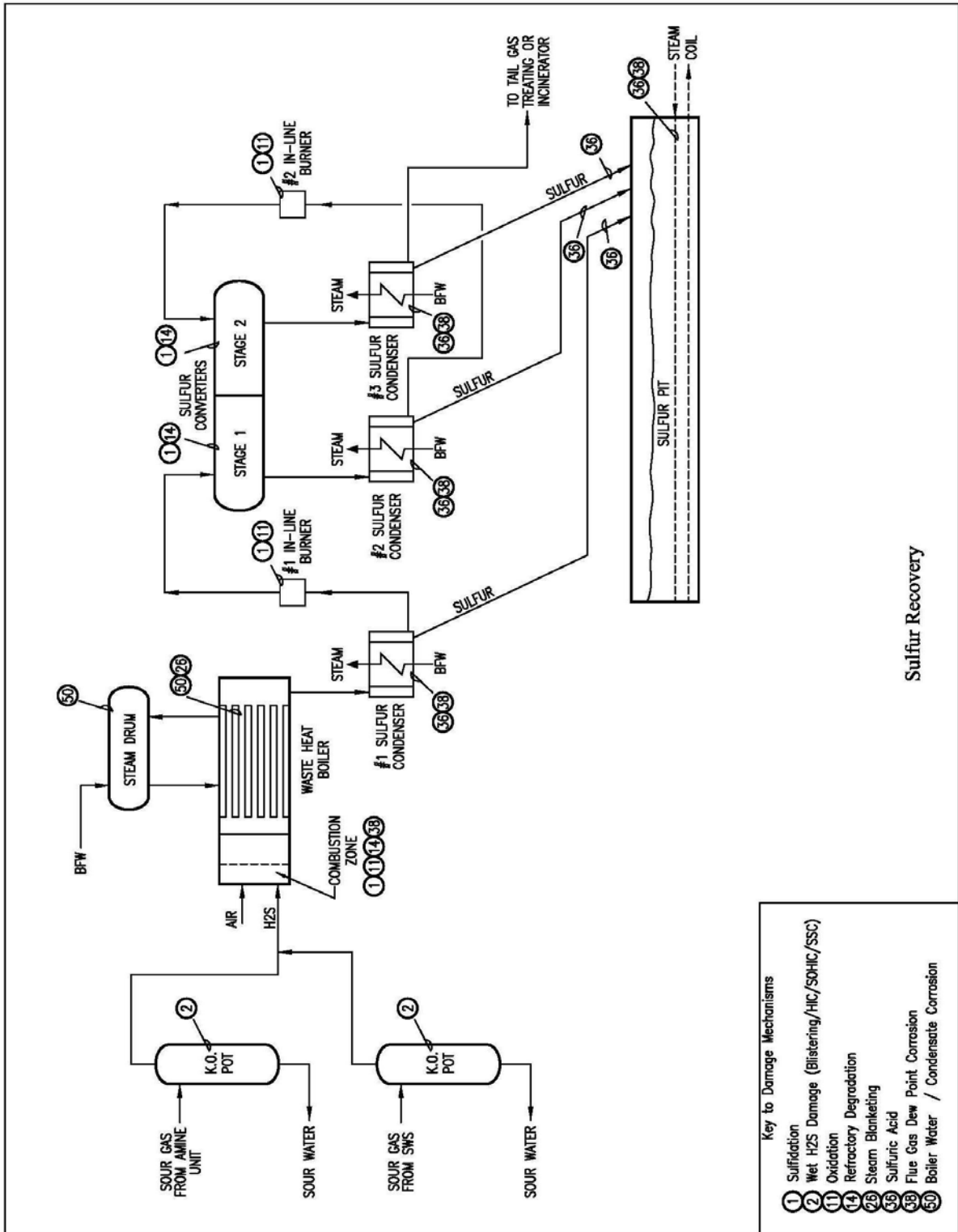


Figure 5-75 – Sulfur Recovery

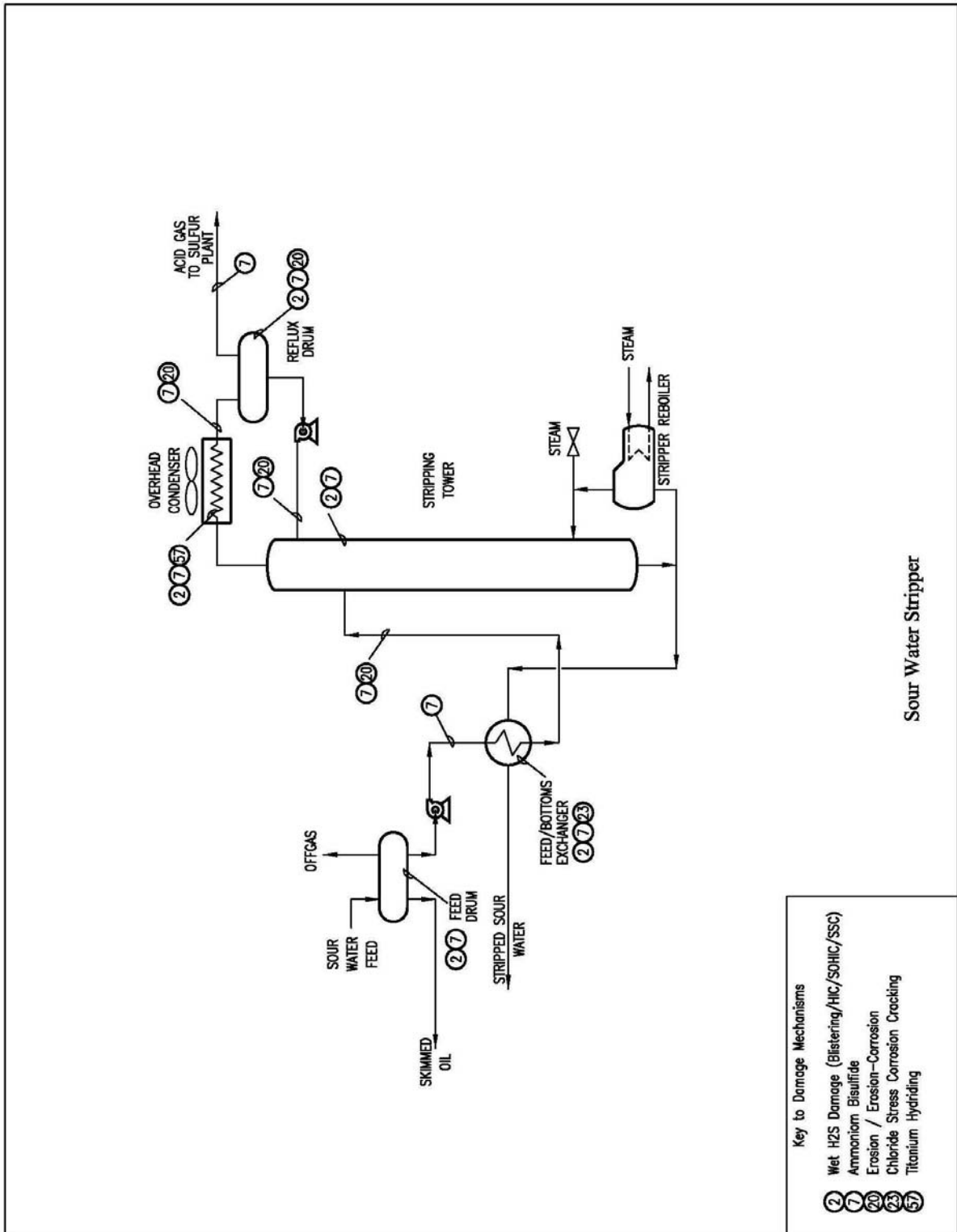


Figure 5-76 – Sour Water Stripper

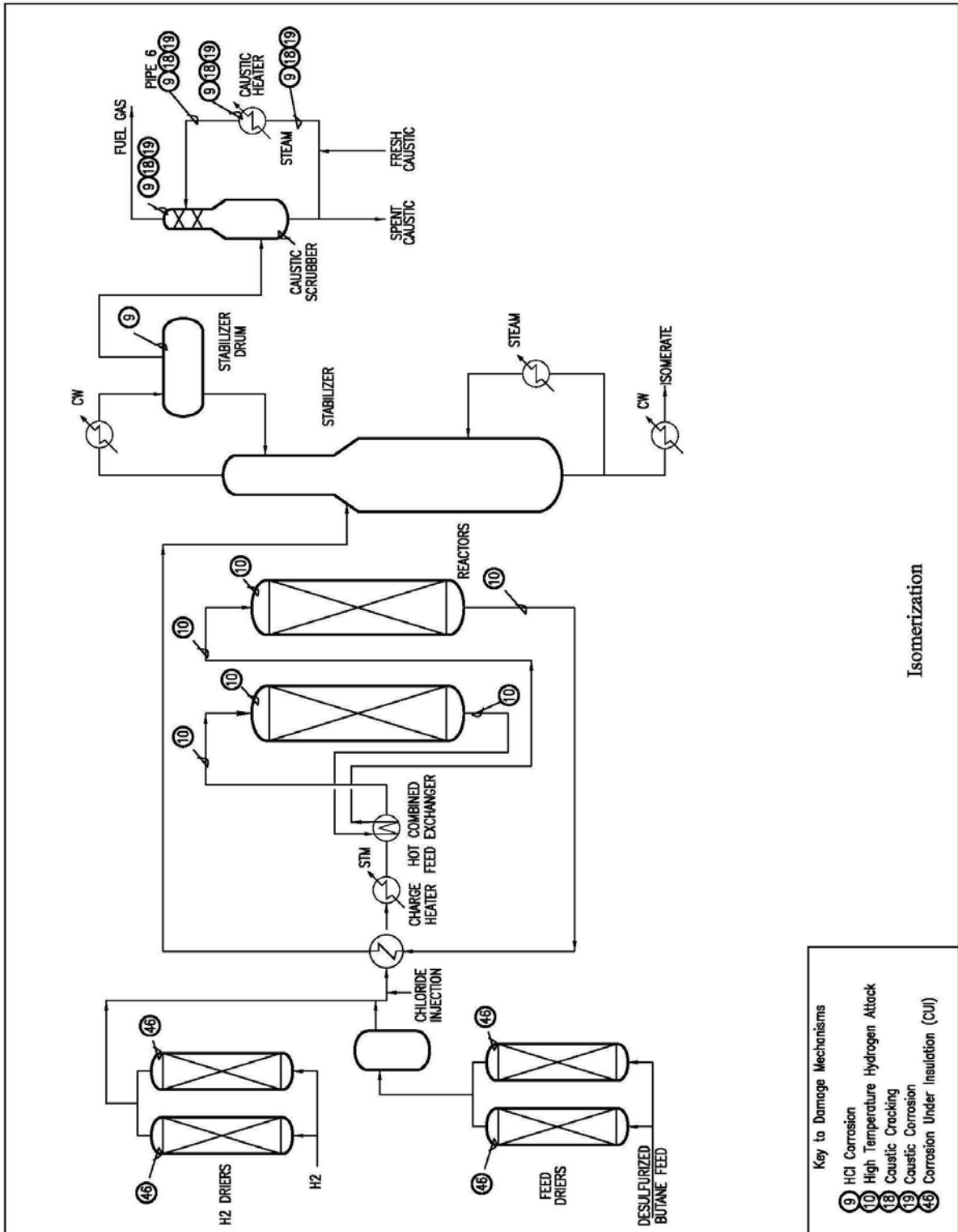


Figure 5-77 – Isomerization



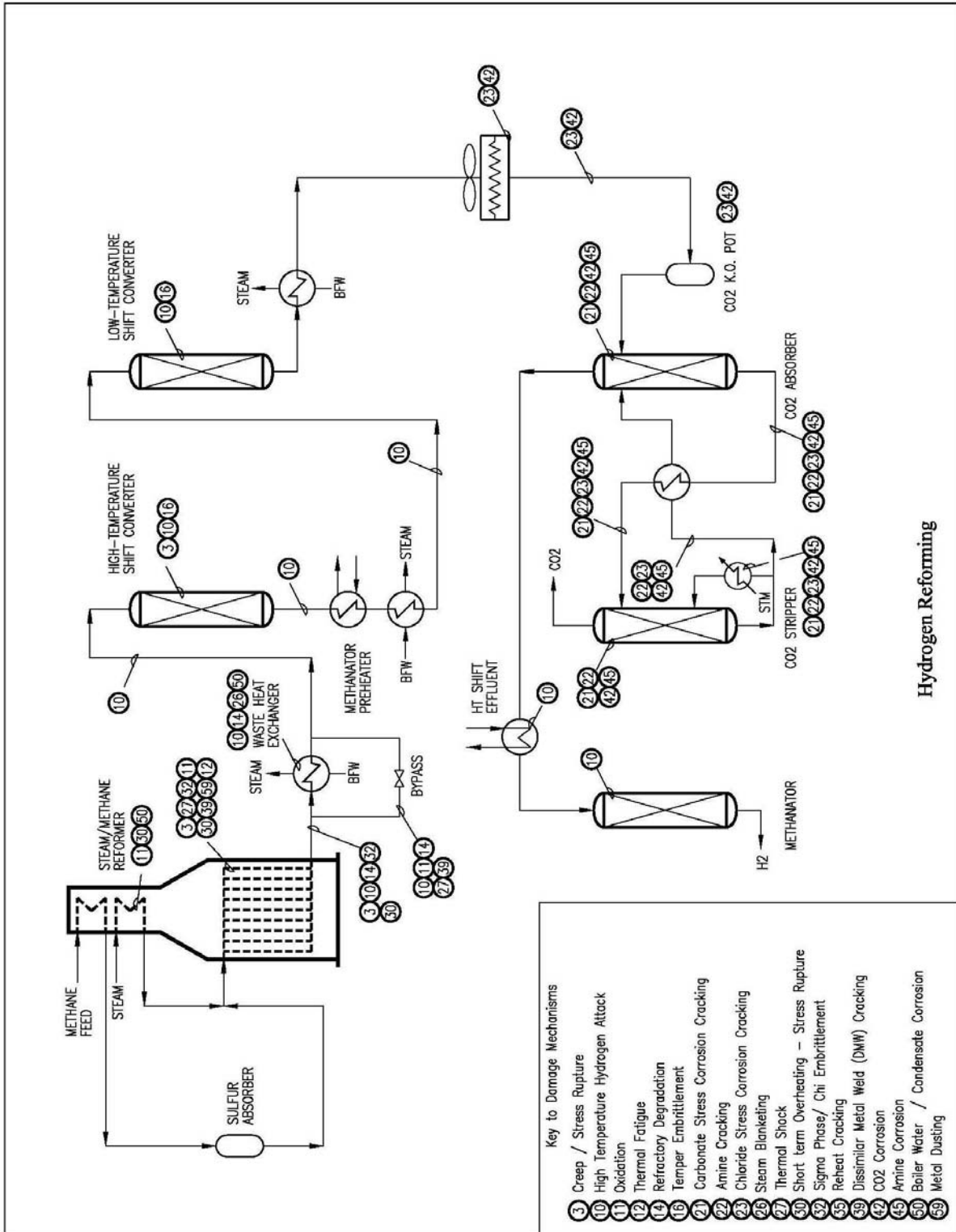


Figure 5-78 – Hydrogen Reforming

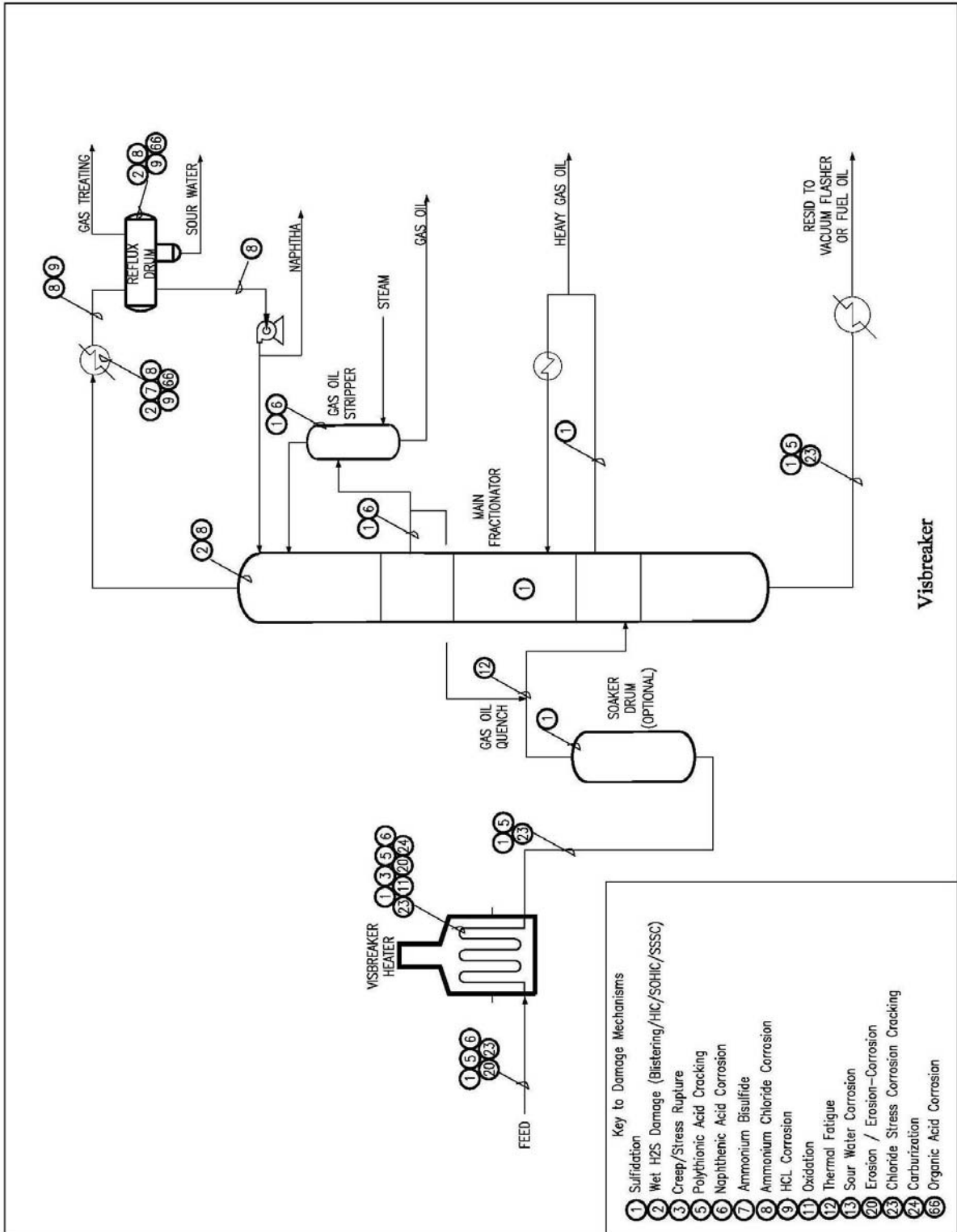


Figure 5-79 – Visbreaker

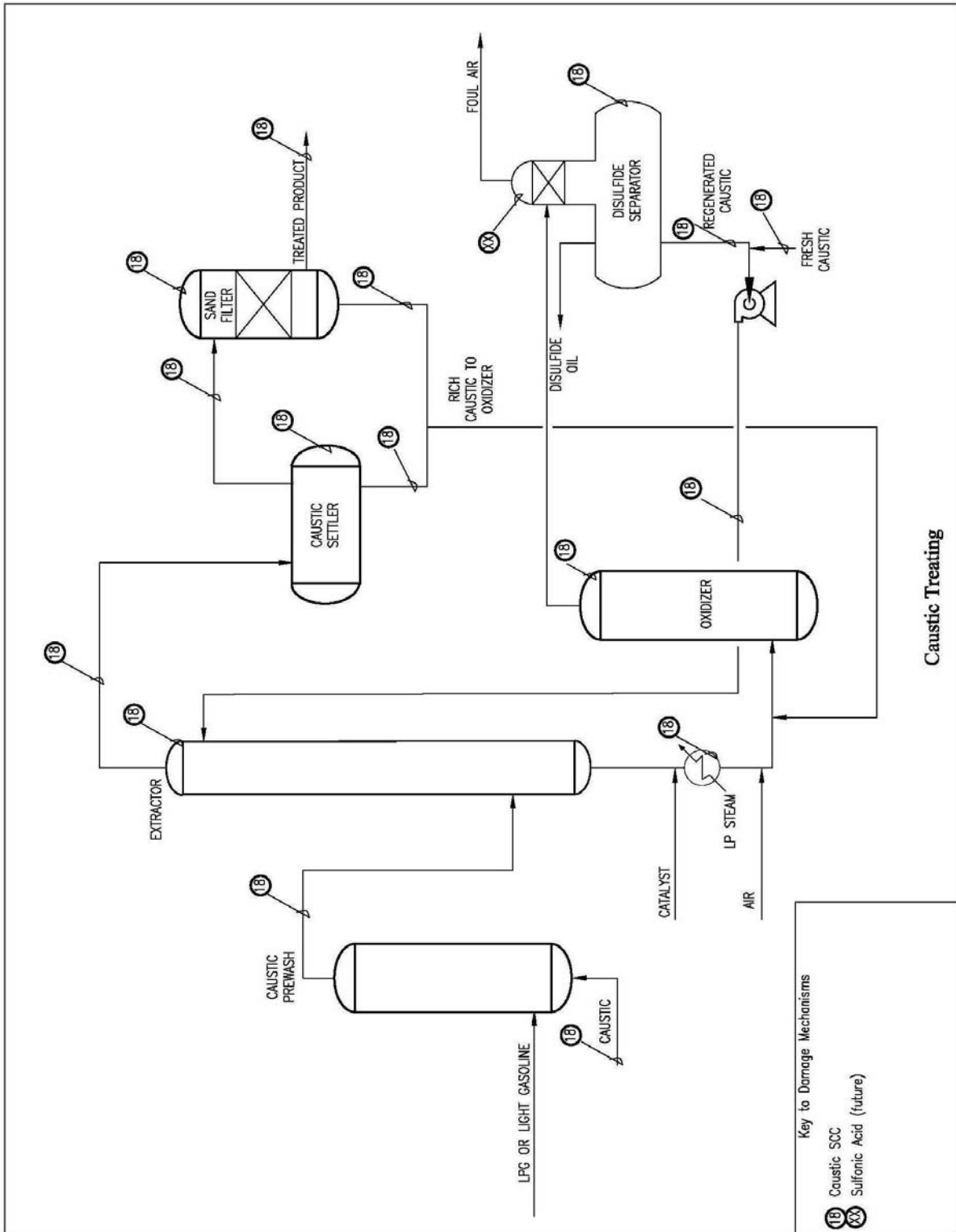


Figure 5-80 – Caustic Treating

*This page intentionally left blank.*

# ANNEX A

## TECHNICAL INQUIRIES

A.1	Introduction .....	A-3
A.2	Inquiry Format .....	A-3

*This page intentionally left blank*

## **A.1 Introduction**

API will consider written requests for interpretations of API Recommended Practice 571. The API staff will make such interpretations in writing after consulting, if necessary, with the appropriate committee officers and committee members. The API committee responsible for maintaining RP 571 meets regularly to consider written requests for interpretations and revisions and to develop new criteria dictated by technological development. The committee's activities in this regard are limited strictly to interpretations of the document and to the consideration of revisions to the current edition of the document on the basis of new data or technology. As a matter of policy, API does not approve, certify, rate, or endorse any item, construction, proprietary device, or activity, and accordingly, inquiries that require such consideration will be returned. Moreover, API does not act as a consultant on specific engineering problems or on the general understanding or application of RP 571. If, based on the inquiry information submitted, it is the opinion of the committee that the inquirer should seek other assistance, the inquiry will be returned with the recommendation that such assistance be obtained. All inquiries that cannot be understood because they lack information will be returned.

## **A.2 Inquiry Format**

**A.2.1** Inquiries shall be limited strictly to requests for interpretation of RP 571 or to the consideration of revisions to the document on the basis of new data or technology. Inquiries shall be submitted in the format described in [A.2.2](#).

**A.2.2** The process for submitting a technical inquiry is now explained in detail on the API website at: <http://www.api.org/Standards/reqint.cfm>. Please read the information on this page for any updates to the process. Please use the following link to access an online form for submitting your request: <http://rfi.api.org/>







AMERICAN PETROLEUM INSTITUTE

**2011  
PUBLICATIONS  
ORDER FORM**

**Effective January 1, 2011. API Members receive a 30% discount where applicable.** The member discount does not apply to purchases made for the purpose of resale or for incorporation into commercial products, training courses, workshops, or other commercial enterprises.

**Online Orders**      [www.api.org/pubs](http://www.api.org/pubs)  
**Phone Orders**     **1-800-854-7179** (Toll-free in the U.S. and Canada) | **(+1) 303-397-7956** (Local and International)  
**Fax Orders**         **(+1) 303-397-2740**

**Date:** \_\_\_\_\_

**API Member** (Check if Yes)

**Invoice To** ( Check here if same as "Ship To")

**Ship To** (UPS will not deliver to a P.O. Box)

Name: \_\_\_\_\_  
 Title: \_\_\_\_\_  
 Company: \_\_\_\_\_  
 Department: \_\_\_\_\_  
 Address: \_\_\_\_\_  
 \_\_\_\_\_  
 City: \_\_\_\_\_ State/Province: \_\_\_\_\_  
 Zip/Postal Code: \_\_\_\_\_ Country: \_\_\_\_\_  
 Telephone: \_\_\_\_\_  
 Fax: \_\_\_\_\_  
 Email: \_\_\_\_\_

Name: \_\_\_\_\_  
 Title: \_\_\_\_\_  
 Company: \_\_\_\_\_  
 Department: \_\_\_\_\_  
 Address: \_\_\_\_\_  
 \_\_\_\_\_  
 City: \_\_\_\_\_ State/Province: \_\_\_\_\_  
 Zip/Postal Code: \_\_\_\_\_ Country: \_\_\_\_\_  
 Telephone: \_\_\_\_\_  
 Fax: \_\_\_\_\_  
 Email: \_\_\_\_\_

Quantity	Title	SO★	Unit Price	Total
	API 510, Pressure Vessel Inspection Code: Maintenance Inspection, Rating, Repair, and Alteration		\$88.00	
	API 570, Piping Inspection Code: In-service Inspection, Rating, Repair, and Alteration of Piping Systems		\$130.00	
	RP 572, Inspection Practices for Pressure Vessels		\$149.00	
	RP 573, Inspection of Fired Boilers and Heaters		\$94.00	
	RP 574, Inspection Practices for Piping System Components		\$132.00	
	RP 575, Inspection of Atmospheric & Low Pressure Storage Tanks		\$126.00	
	RP 576, Inspection of Pressure-relieving Devices		\$130.00	
	Std 579-1/ASME FFS-1, Fitness-For-Service		\$683.00	

Payment Enclosed       P.O. No. (Enclose Copy) \_\_\_\_\_  
 Charge My IHS Account No. \_\_\_\_\_  
 VISA                               MasterCard                       American Express  
 Diners Club                       Discover  
 Credit Card No.: \_\_\_\_\_  
 Print Name (As It Appears on Card): \_\_\_\_\_  
 Expiration Date: \_\_\_\_\_  
 Signature: \_\_\_\_\_

<b>Subtotal</b>	
<b>Applicable Sales Tax</b> (see below)	
<b>Rush Shipping Fee</b> (see below)	
<b>Shipping and Handling</b> (see below)	
<b>Total</b> (in U.S. Dollars)	

★ To be placed on Standing Order for future editions of this publication, place a check mark in the SO column and sign here:

*Pricing and availability subject to change without notice.*

**Mail Orders** – Payment by check or money order in U.S. dollars is required except for established accounts. State and local taxes, \$10 processing fee, and 5% shipping must be added. Send mail orders to: **API Publications, IHS, 15 Inverness Way East, c/o Retail Sales, Englewood, CO 80112-5776, USA.**

**Purchase Orders** – Purchase orders are accepted from established accounts. Invoice will include actual freight cost, a \$10 processing fee, plus state and local taxes.

**Telephone Orders** – If ordering by telephone, a \$10 processing fee and actual freight costs will be added to the order.

**Sales Tax** – All U.S. purchases must include applicable state and local sales tax. Customers claiming tax-exempt status must provide IHS with a copy of their exemption certificate.

**Shipping (U.S. Orders)** – Orders shipped within the U.S. are sent via traceable means. Most orders are shipped the same day. Subscription updates are sent by First-Class Mail. Other options, including next-day service, air service, and fax transmission are available at additional cost. Call 1-800-854-7179 for more information.

**Shipping (International Orders)** – Standard international shipping is by air express courier service. Subscription updates are sent by World Mail. Normal delivery is 3-4 days from shipping date.

**Rush Shipping Fee** – Next Day Delivery orders charge is \$20 in addition to the carrier charges. Next Day Delivery orders must be placed by 2:00 p.m. MST to ensure overnight delivery.

**Returns** – All returns must be pre-approved by calling the IHS Customer Service Department at 1-800-624-3974 for information and assistance. There may be a 15% restocking fee. Special order items, electronic documents, and age-dated materials are non-returnable.

# THERE'S MORE WHERE THIS CAME FROM.

## **API Monogram® Licensing Program**

Sales: (+1) 713-964-2662  
Service: (+1) 202-962-4791  
Fax: (+1) 202-682-8070  
Email: [certification@api.org](mailto:certification@api.org)  
Web: [www.api.org/monogram](http://www.api.org/monogram)

## **API Quality Registrar (APIQR®)**

- ISO 9001
- ISO/TS 29001
- ISO 14001
- OHSAS 18001
- API Spec Q1®
- API QualityPlus®
- Dual Registration

Sales: (+1) 713-964-2662  
Service: (+1) 202-962-4791  
Fax: (+1) 202-682-8070  
Email: [certification@api.org](mailto:certification@api.org)  
Web: [www.api.org/apiqr](http://www.api.org/apiqr)

## **API Individual Certification Programs (ICP®)**

Sales: (+1) 713-964-2662  
Service: (+1) 202-682-8064  
Fax: (+1) 202-682-8348  
Email: [icp@api.org](mailto:icp@api.org)  
Web: [www.api.org/icp](http://www.api.org/icp)

## **API Engine Oil Licensing and Certification System (EOLCS)**

Sales: (+1) 713-964-2662  
Service: (+1) 202-682-8516  
Fax: (+1) 202-962-4739  
Email: [eolcs@api.org](mailto:eolcs@api.org)  
Web: [www.api.org/eolcs](http://www.api.org/eolcs)

## **API Training Provider Certification Program (API TPCP™)**

Sales: (+1) 713-964-2662  
Service: (+1) 202-682-8075  
Fax: (+1) 202-682-8070  
Email: [tpcp@api.org](mailto:tpcp@api.org)  
Web: [www.api.org/tpcp](http://www.api.org/tpcp)

## **API Perforator Design Registration Program**

Sales: (+1) 713-964-2662  
Service: (+1) 202-682-8490  
Fax: (+1) 202-682-8070  
Email: [perfdesign@api.org](mailto:perfdesign@api.org)  
Web: [www.api.org/perforators](http://www.api.org/perforators)

## **API Credit Exchange (ACE™)**

Service: (+1) 202-682-8192  
Fax: (+1) 202-682-8070  
Email: [exchange@api.org](mailto:exchange@api.org)  
Web: [www.api.org/ace](http://www.api.org/ace)

## **API Diesel Exhaust Fluid Certification Program**

Phone: (+1) 202-682-8516  
Fax: (+1) 202-962-4739  
Email: [info@apidef.org](mailto:info@apidef.org)  
Web: [www.apidef.org](http://www.apidef.org)

## **API WorkSafe™**

Sales: (+1) 713-964-2662  
Service: (+1) 202-682-8469  
Fax: (+1) 202-682-8348  
Email: [apiworksafe@api.org](mailto:apiworksafe@api.org)  
Web: [www.api.org/worksafe](http://www.api.org/worksafe)

## **API-U**

Phone: (+1) 202-682-8053  
Fax: (+1) 202-682-8070  
Email: [training@api.org](mailto:training@api.org)  
Web: [www.api-u.org](http://www.api-u.org)

## **API Data™**

Phone: (+1) 202-682-8499  
Fax: (+1) 202-962-4730  
Email: [apidata@api.org](mailto:apidata@api.org)  
Web: [www.APIDataNow.org](http://www.APIDataNow.org)

## **API Publications**

Online: [www.api.org/pubs](http://www.api.org/pubs)  
Phone: 1-800-854-7179  
(Toll-free: U.S./Canada)  
(+1) 303-397-7956  
(Local/International)  
Fax: (+1) 303-397-2740

## **API Standards**

Phone: (+1) 202-682-8148  
Fax: (+1) 202-962-4797  
Email: [standards.org](mailto:standards.org)  
Web: [www.api.org/standards](http://www.api.org/standards)

---

**Request a Quotation:**  
**[www.api.org/quote](http://www.api.org/quote)**

---



AMERICAN PETROLEUM INSTITUTE





AMERICAN PETROLEUM INSTITUTE

1220 L Street, NW  
Washington, DC 20005-4070  
USA

202-682-8000

**Additional copies are available online at [www.api.org/pubs](http://www.api.org/pubs)**

Phone Orders: 1-800-854-7179 (Toll-free in the U.S. and Canada)  
303-397-7956 (Local and International)  
Fax Orders: 303-397-2740

Information about API publications, programs and services is available  
on the web at [www.api.org](http://www.api.org).

**Product No. C57102**